



MERCHANDISERS



Merchandisers

Table of Contents

1.877.453.3964

1.877.453.5050

www.dynaline.com

orders@dynaline.com



Merchandisers

A		L	
Aluminum Pulleys	47	Load Binder/Cable Puller Rack	33
Assortments Plan-O-Gram	32	Lubrication Plan-O-Gram	25
B		Lubrication Plan-O-Gram	28
Ball Mount Rack	20	M	
Bronze Bushings	49	Machinery Bushings	55
Bulk Bin Merchandisers	6	Merchandiser	30
C		Merchandiser - Driver Bit	68, 69
Cargo Control Plan-O-Gram	33	Merchandiser - Farm Packs	61
Caster & Assorted Wheels	63	Merchandiser Rack	4
Caster Wheels Plan-O-Gram	62	Muffler Clamps	45
Chain & Steel Cable Rack	40	O	
Chain and Rigging Bulk	7	O-Ring Tilt Bins	23
Chain Connectors	36	P	
Chain Hooks	37	Padlocks	64
Chain Rack	39	Pins	56
Compact Driver Bit Display	67	Pulley Blocks	46
Custom Bulk Bin	71	R	
Cutters and Blades	64	Retainer Rings	53
D		Retainer Rings Tilt Bins	54
Drill Bit Display	65	S	
Driver Bit Kit Display	66	S.A.E. O-Rings	22
Dynakit Merchandiser	31	Shackles & Clevises	37
Dynaline Bin Box	73	Small Wheel Rack	62
E		Snaps	43, 50
E-Grip & Forged Steel Hitch Pins	58	Springs	51, 52
End Cap Display	29	Stainless Steel Hardware	35
Eyebolts & Rings	44	Storage Bins	72
F		Stroke Control	60
Farm Hardware	57	T	
Farm Hardware / Chain and Rigging Bulk	12, 13	Three-Blade Cutter Display	65
Farm Hardware Bulk Rack	8, 9, 10	Tilt Bins	73
Funnel - & Lubrication Merchandiser	26	Tractor Linkage Parts	60
Funnel - Tree Merchandiser	21	Trailer & Towing Plan-O-Gram	16
G		Trailer & Towing Plan-O-Gram	17
General Hardware	41, 42	Trailer & Towing Plan-O-Gram	18
General Hardware Bulk Rack	10, 11	Trailer & Towing Plan-O-Gram	19
Grade 8 Hitch Pins	58	Trailer Balls	14
Grease Accessories	24	Trailer Couplers	15
H		Turnbuckles	48
Hitch Pins	59	U	
I		U-Bolts	45
Interlocking Bin Components	74	Universal Display Boards	70
J		W	
Jack Rack	20	Weather Caps	61
K		Wire Rope Accessories	34
Keystock	55	Wire Rope Accessories	38



Merchandisers

Free Standing Merchandiser Rack

1.877.453.3964

1.877.453.5050

www.dynaline.com

orders@dynaline.com

Free Standing Customizable Merchandiser



CUSTOMER FAVORITE

Fully Customizable

Easy Setup, stock and update.

Great ROI per Sq/foot. Only uses 4 Sq/Ft of retail space.

We can help you choose the best product mix for your business.

We will assist the change to our merchandisers.

Flat base or caster wheel base options.



**Merchandiser Boards Sold Separately*

**No Pegs supplied for Gondola merchandisers*

00024 - Merchandiser Rack

Sturdy, free standing floor unit securely holds up to twelve 24" x 24" or up to twenty four 12" x 24" DYNALINE Board Merchandisers. Includes rack and assembly hardware.

Dimensions: 24" x 24" x 84".

PART#	CONTENTS
00024	Merchandiser Rack Only
00024-1	Set of 4 Caster Wheels Only. Swivel and Locking (optional)



**Caster option available*

Merchandisers



The 00024 merchandiser is one of the most versatile merchandisers in the market.

Once the frame is setup it can accommodate many different layouts and product categories. Along with multiple categories of products that can be displayed, Dynaline also offers multiple sizing options for many of the display boards increasing options and control of merchandise even further (see below).

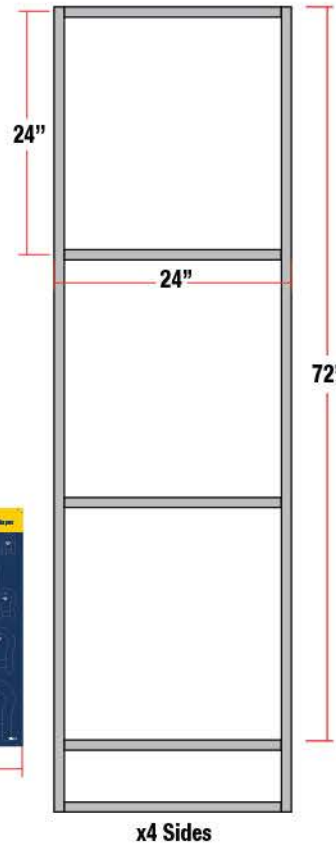

Mix and match our 36 board options!

Trailer Balls - Part# 00208

Trailer Couplers - Part# 00215

Machinery Bushings - Part# 00235

Bronze Bushings - Part# 00325

Dynakit Assortments - Part# 00296

Dynatray Assortments - Part# 00031

S.A.E O-Rings - Part# 00318

Grease Accessories - Part# 00527

Springs : Retail packaged - Part# 00242

Springs : Expanded selection - Part# 00244

Bulk Springs - Part# 00243

Retainer Rings - Part# 00245

Turnbuckles : Gen. purpose - Part# 00416

Turnbuckles : Forged Steel- Part# 00417

Snaps - Part# 00447 & Part# 00448

Padlocks - Part# 00225

Eyebolts and Rings - Part# 00611

Muffler Clamps - Part# 00307

Hitch Pins - Part# 00436

Grade 8 Hitch Pins - Part# 00439

E-Grip Hitch Pins - Part# 00441

Hitch Pins - Ext Selection - Part# 00435

Wire Rope Accessories - Part# 00566/00567

Stainless Steel Hardware - Part# 00619

Chain Connectors - Part# 00614

Chain Hooks - Part# 00408

Shackles and Clevises - Part# 00386

Stroke Control - Part# 00297

Universal Display Boards - Part# 00800

U-Bolt - Part# 00612

Weather Caps - Part# 00226

Pulley Blocks - Part# 00334

Aluminum Pulleys - Part# 00335

Pins - Part# 00557

Tractor Linkage Parts - Part# 00438/00437

Farm Packs - Part# 00620



Bulk Bin Merchandisers



FEATURES:

1. Heavy-duty casters for easy movement around your retail space.
2. Quick visual references to improve the shopping experience.
3. Attractive appearance elevates the appeal of your space.

BENEFITS:

4. Popular product selection to maximize inventory turns.
5. Keeps your bulk stock clean, organized, and easy to find.
6. Makes inventory management simple and efficient.

- Four types of Merchandisers available (see following pages for contents):

Chain and Rigging - 00030K

Farm Hardware - 00032K

General Hardware - 00034K

Farm Hardware / Chain and Rigging - 00036K

- Dimensions: 36" x 24" x 72"
- Maximize Return on Investment
- Customizable boards
- 4", 6" & 8", 12" interlocking bins used





Chain and Rigging Bulk Merchandiser



PART#	CONTENTS
-------	----------

00028 Bulk Display Rack Only - 72" x 32" x 24" - 7 shelves

00030K Full Merchandiser. 104 part #'s, 859 pieces. Includes: 4 sign headers, bulk bin interlocking displays, bin labels and the products listed below:

PART#	DESCRIPTION	QUANTITY	PART#	DESCRIPTION	QUANTITY
66000	Anchor Shackle 1/4 1/2 Ton WLL	5 ea.	66138	Mid Link 1/4"-5/16" 4700 lb WLL	5 ea.
66001	Anchor Shackle 5/16 3/4 Ton WLL	5 ea.	66139	Mid Link 3/8 6600 lb WLL	5 ea.
66002	Anchor Shackle 3/8" 1 Ton WLL	5 ea.	66140	Mid Link 7/16"-1/2" 11250 lb WLL	5 ea.
66003	Anchor Shackle 7/16" 1-1/2 Ton WLL	5 ea.	66145	Eye Hoist Hook 3/4T. C/W Latch	3 ea.
66004	Anchor Shackle 1/2" 2 Ton WLL	5 ea.	66146	Eye Hoist Hook 1T. C/W Latch	3 ea.
66005	Anchor Shackle 5/8" 3-1/4 Ton WLL	5 ea.	66147	Eye Hoist Hook 1-1/2T. C/W Latch	3 ea.
66006	Anchor Shackle 3/4" 4-3/4 Ton WLL	5 ea.	66165	Forged Chain Swivel 1/4 850 lb WLL	3 ea.
66007	Anchor Shackle 7/8 6-1/2 Ton WLL	5 ea.	66166	Forged Chain Swivel 5/16" 1,250 lb WLL	3 ea.
66008	Anchor Shackle 1 8-1/2 Ton WLL	5 ea.	66167	Forged Chain Swivel 3/8" 2,250 lb WLL	3 ea.
66010	Anchor Shackle 1/4 600 lb WLL	5 ea.	66168	Forged Chain Swivel 1/2 3,600 lb WLL	3 ea.
66011	Anchor Shackle 5/16 1/2 Ton WLL	5 ea.	66121	Clevis Grab Hook (Alloy) 5/16	5 ea.
66012	Anchor Shackle 3/8 3/4 Ton WLL	5 ea.	66122	Clevis Grab Hook (Alloy) 3/8	5 ea.
66013	Anchor Shackle 1/2 1-1/2 Ton WLL	5 ea.	66126	Clevis Grab Hook (Alloy) 7/16	5 ea.
66014	Anchor Shackle 5/8 2-1/4 Ton WLL	5 ea.	66127	Clevis Grab Hook (Alloy) 1/2	5 ea.
66017	Anchor Shackle 7/16 1-1/4 Ton WLL	5 ea.	66070	Clevis Slip Hook C/W Latch 1/4	5 ea.
66020	Chain Shackle 1/4 1/2 Ton WLL	5 ea.	66071	Clevis Slip Hk C/W Latch 5/16	5 ea.
66021	Chain Shackle 5/16 3/4 Ton WLL	5 ea.	66072	Clevis Slip Hook C/W Latch 3/8	5 ea.
66022	Chain Shackle 3/8" 1 Ton WLL	5 ea.	66110	Clevis Grab Hook 1/4	5 ea.
66023	Chain Shackle 7/16" 1-1/2 Ton WLL	5 ea.	66111	Clevis Grab Hook 5/16	5 ea.
66024	Chain Shackle 1/2 2 Ton WLL	5 ea.	66112	Clevis Grab Hook 3/8	5 ea.
66073	Clevis Slip Hook C/W Latch 1/4	5 ea.	66115	Clevis Slip Hook 1/4	5 ea.
66074	Clevis Slip Hook W/ Latch 5/16	5 ea.	66116	Clevis Slip Hook 5/16	5 ea.
66075	Clevis Slip Hook C/W Latch 3/8	5 ea.	66117	Clevis Slip Hook 3/8	5 ea.
66076	Clevis Slip Hook C/W Latch 1/2	5 ea.	66136	Safety Winch Hook 1/4	5 ea.
66120	Clevis Grab Hook (Alloy) 1/4	5 ea.			

Chain and Rigging Bulk Merchandiser Continued

PART#	DESCRIPTION	QUANTITY	PART#	DESCRIPTION	QUANTITY
66430	Quick Link 1/8" WLL 220lbs	2 Pkg of 10	77042	Forged Clip 1/4	1 Pkg of 5
66431	Quick Link 3/16" WLL 660lbs	2 Pkg of 10	77043	Forged Clip 5/16	1 Pkg of 5
66432	Quick Link 1/4" WLL 880lbs	2 Pkg of 10	77044	Forged Clip 3/8	1 Pkg of 5
66433	Quick Link 5/16" WLL 1760lbs	4 Pkg of 5	77045	Forged Clip 1/2	1 Pkg of 5
66434	Quick Link 3/8" WLL 2200lbs	4 Pkg of 5	77046	Forged Clip 5/8	3 ea.
66435	Quick Link 7/16" WLL 2640lbs	4 Pkg of 5	77047	Forged Clip 3/4	3 ea.
66436	Quick Link 1/2" WLL 3300lbs	4 Pkg of 5	77050	Thimble 1/8	1 Pkg of 10
66400	Repair Link 1/8" 1/8" x 3/4"	1 Pkg of 10	77051	Thimble 3/16	1 Pkg of 10
66401	Repair Link 3/16 3/16 x 1	1 Pkg of 10	77052	Thimble 1/4"	1 Pkg of 10
66402	Repair Link 1/4 1/4 x 1-1/4	1 Pkg of 10	77053	Thimble 5/16	1 Pkg of 10
66403	Repair Link 5/16 5/16 x 1-1/2	2 Pkg of 5	77054	Thimble 3/8	1 Pkg of 10
66404	Repair Link 3/8 3/8 x 1-5/8	2 Pkg of 5	77055	Thimble 1/2	1 Pkg of 5
67020	Connecting Link 1/4 Grade 80	5 ea.	77056	Thimble 5/8	3 ea.
67021	Connecting Link 5/16 Grade 80	5 ea.	77070	Cable Stop 1/16"	1 Pkg of 10
67022	Connecting Link 3/8 Grade 80	5 ea.	77071	Stop 3/32	1 Pkg of 10
67023	Connecting Link 1/2 Grade 80	5 ea.	77072	Stop 1/8	1 Pkg of 10
77030	Malleable Clip 1/8"	2 Pkg of 10	77073	Stop 5/32	1 Pkg of 10
77031	Malleable Clip 3/16	2 Pkg of 10	77074	Stop 3/16	1 Pkg of 10
77032	Malleable Clip 1/4	2 Pkg of 10	77075	Stop 1/4	1 Pkg of 5
77033	Malleable Clip 5/16	2 Pkg of 10	77080	Ferrule 1/16	2 Pkg of 10
77034	Malleable Clip 3/8	4 Pkg of 5	77081	Ferrule 3/32	2 Pkg of 10
77035	Malleable Clip 1/2"	2 Pkg of 5	77082	Ferrule 1/8	2 Pkg of 10
77036	Malleable Clip 5/8"	10 ea.	77083	Ferrule 5/32	2 Pkg of 10
77037	Malleable Clip 3/4	3 ea.	77084	Ferrule 3/16	2 Pkg of 10
77038	Malleable Clip 7/8	3 ea.	77085	Ferrule 1/4	2 Pkg of 10
77039	Malleable Clip 1	3 ea.	77086	Ferrule 5/16	1 Pkg of 10
77040	Forged Clip 1/8	1 Pkg of 5	77087	Ferrule 3/8	1 Pkg of 10
77041	Forged Clip 3/16	1 Pkg of 5			

 Choose your own boards for the sides!

Farm Hardware Bulk Merchandiser



Farm Hardware Bulk Merchandiser Continued

PART#	CONTENTS
00028	Bulk Display Rack Only - 72" x 32" x 24" - 7 shelves
00032K	Full Merchandiser. 152 part #'s, 826 pieces. Includes: 4 sign headers, bulk bin interlocking displays, bin labels and the products listed below:

PART#	DESCRIPTION	QUANTITY
66251	Hitch Pin 1/2 x 3-5/8 - Red Handle	5 ea.
66252	Hitch Pin 5/8 x 4 - Red Handle	5 ea.
66253	Hitch Pin 3/4 x 4 - Red Handle	5 ea.
66254	Hitch Pin 7/8 x 4-1/4 - Red Handle	5 ea.
66255	Hitch Pin 1 x 4-3/4 - Red Handle	5 ea.
66256	Hitch Pin 5/8 x 5-3/4 - Red Handle	5 ea.
66257	Hitch Pin 3/4 x 6-1/2 - Red Handle	5 ea.
66258	Hitch Pin 7/8 x 6-1/2 - Red Handle	5 ea.
66259	Hitch Pin 1 x 7-1/2 - Red Handle	5 ea.
66260	Hitch Pin 1-1/8 x 8-1/2 - Red Handle	5 ea.
66261	Hitch Pin 1-1/4 x 8-1/2 - Red Handle	5 ea.
66263	Hitch Pin 1-1/2 x 8-1/2 - Red Handle	5 ea.
66280	Hitch Pin 1/2 x 4-1/4 C/W Chain & Linch Pin	5 ea.
66281	Hitch Pin 5/8 x 4-1/4 C/W Chain & Linch Pin	5 ea.
66282	Hitch Pin 5/8 x 6-1/4 C/W Chain & Linch Pin	5 ea.
66283	Hitch Pin 3/4 x 4-1/4 C/W Chain & Linch Pin	5 ea.
66284	Hitch Pin 3/4 x 6-1/4 C/W Chain & Linch Pin	5 ea.
66285	Hitch Pin 7/8 x 6-1/4 C/W Chain & Linch Pin	5 ea.
66286	Hitch Pin 1 x 6-1/4 C/W Chain & Linch Pin	5 ea.
66288	Hitch Pin 1-1/4 x 6-1/4 C/W Chain & Linch Pin	2 ea.
66287	Hitch Pin 1-1/8 x 6-1/4 C/W Chain & Linch Pin	2 ea.
66250	Hitch Pin 3/8 x 3	5 ea.
66500	Quick Release Pin 1/4 x 1-1/2	2 Pkg of 5
66503	Quick Release Pin 1/4 x 2-1/2	2 Pkg of 5
66516	Quick Release Pin 3/8 x 2	2 Pkg of 5
66518	Quick Release Pin 3/8 x 2-1/2	2 Pkg of 5
66244	Spring Lock Pin 1/2 x 4-1/4	5 ea.
66245	Spring Lock Pin 5/8 x 4-1/4	5 ea.
66450	Linch Pin 3/16	2 Pkg of 10
66451	Linch Pin 1/4	2 Pkg of 10
66452	Linch Pin 5/16	2 Pkg of 10
66453	Linch Pin 3/8	2 Pkg of 10
66454	Linch Pin 7/16	2 Pkg of 10
66455	Linch Pin 7/16	2 Pkg of 10

PART#	DESCRIPTION	QUANTITY
66460	Quick Pin 1/4" x 1-3/8"	2 Pkg of 5
66461	Quick Pin 1/4" x 1-3/4"	2 Pkg of 5
66463	Quick Pin 5/16 x 1-3/8	2 Pkg of 5
66464	Quick Pin 5/16" x 1-3/4"	2 Pkg of 5
66466	Quick Pin 3/8 x 1-3/8	2 Pkg of 5
66469	Quick Pin 5/8 x 3-1/8	10 ea.
66462	Quick Pin 1/4 x 2-1/2	2 Pkg of 5
66465	Quick Pin 5/16 x 2-1/2	2 Pkg of 5
66467	Quick Pin 3/8" x 2-1/4"	2 Pkg of 5
66468	Quick Pin 3/8 x 2-1/2	2 Pkg of 5
66531	Tab Quick Pin 1/4 x 1-5/8 Round	2 Pkg of 5
66532	Tab Quick Pin 1/4 x 2 Round	2 Pkg of 5
66533	Tab Quick Pin 1/4 x 2-3/4 Round	2 Pkg of 5
66534	Tab Quick Pin 5/16 x 1-5/8 Round	2 Pkg of 5
66535	Tab Quick Pin 5/16 x 2 Round	2 Pkg of 5
66536	Tab Quick Pin 5/16 x 2-3/4 Round	2 Pkg of 5
66537	Tab Quick Pin 3/8 x 1-5/8 Round	2 Pkg of 5
66538	Tab Quick Pin 3/8 x 2-1/2 Round	2 Pkg of 5
66539	Tab Quick Pin 3/8 x 2-3/4 Round	2 Pkg of 5
66470	Safety Pin 1/8 x3-1/8 x 1-1/16	1 Pkg of 10
66472	Safety Pin 3/16 x 3-3/8 x 1-1/2	2 Pkg of 5
66474	Safety Pin 1/4 x 5-1/4 x 1-3/4	2 Pkg of 5
66489	Safety Pin 3/32x1-11/16x5/8	1 Pkg of 10
66490	Safety Pin 1/8x2-13/16x13/16	1 Pkg of 10
66491	Safety Pin 3/16 x 3 x 1-1/2	2 Pkg of 5
66492	Safety Pin 5/32 x3-3/4 x1-1/8	2 Pkg of 5
66493	Safety Pin 15/64 x 5 x 1-5/8	2 Pkg of 5
66494	Safety Pin 15/64x 5x2-1/4	2 Pkg of 5
66501	Quick Release Pin 1/4 x 2	2 Pkg of 5
66520	Quick Release Pin 3/8 x 3-1/2	2 Pkg of 5
66527	Quick Release Pin 1/2 x 2-1/2	2 Pkg of 5
66528	Quick Release Pin 1/2 x 3	2 Pkg of 5
66029	Straight Clevis 1/2 6000 lb WLL	5 ea.
66030	Straight Clevis 5/8 12000 lb WLL	5 ea.
66031	Straight Clevis 3/4 16000 lb WLL	5 ea.
66032	Straight Clevis 7/8 20000 lb WLL	3 ea.
66033	Straight Clevis 1 25000 lb WLL	3 ea.
11225	Muffler Clamp 1-1/2 3/8 wire diameter	5 ea.
11226	Muffler Clamp 1-5/8 3/8 wire diameter	5 ea.





Merchandisers

Farm Hardware Bulk Merchandiser Continued

11227	Muffler Clamp 1-3/4 3/8 wire diameter	5 ea.	11220	Universal Tail Pipe Hanger Open End Design	5 ea.
11228	Muffler Clamp 1-7/8 3/8 wire diameter	5 ea.	17720	Manual Holder 2" x 12-1/2" Screw Top Lid	3 ea.
11229	Muffler Clamp 2 3/8 wire diameter	5 ea.	17730	Manual Holder 3-1/4" x 12-1/2" Screw Top Lid	2 ea.
11230	Muffler Clamp 2-1/8 3/8 wire diameter	5 ea.	17740	Tube Style Document Holder Aluminum. 1-1/2"D x 9"L	2 ea.
11231	Muffler Clamp 2-1/4 3/8 wire diameter	5 ea.	00439K	Grade 8 Hitch Pin Merchandiser (Board + Product)	1
11232	Muffler Clamp 2-1/2 3/8 wire diameter	5 ea.	00441K	E-grip and forged steel hitch pin merch (Board + Product)	1
11233	Muffler Clamp 2-3/4 3/8 wire diameter	5 ea.	00438K	Tractor Linkage parts Merchandiser (Board + Product)	1
11234	Muffler Clamp 3 3/8 wire diameter	5 ea.	00297K	Stroke control Merchandiser (Board + Product)	1
11235	Muffler Clamp 3-1/2 3/8 wire diameter	5 ea.	00226K	Weather caps Merchandiser (Board +Product) 1	
11236	Muffler Clamp 4 3/8 wire diameter	5 ea.			
11237	Muffler Clamp 4-1/2 3/8 wire diameter	5 ea.			
11238	Muffler Clamp 5 3/8 wire diameter	5 ea.			
11240	Muffler Clamp 6 3/8 wire diameter	5 ea.			

General Hardware Bulk Merchandiser



PART#	CONTENTS
00028	Bulk Display Rack Only - 72" x 32" x 24" - 7 shelves
00034K	Full Merchandiser. 255 part #'s, 1930 pieces. Includes: 4 sign headers, bulk bin interlocking displays, bin labels and the products listed below:

PART#	DESCRIPTION	QUANTITY	PART#	DESCRIPTION	QUANTITY
65140	U-Bolts 1/4 x 1-1/8	1 Pkg of 10	65149	U-Bolt 5/16 x 2-1/2	1 Pkg of 10
65141	U-Bolt 1/4 x 1-3/8	1 Pkg of 10	65150	U-Bolt 5/16 x 2-1/2	1 Pkg of 10
65142	U-Bolt 1/4 x 2	1 Pkg of 10	65151	U-Bolt 3/8 x 2-1/2	1 Pkg of 10
65143	U-Bolt 5/16 x 1-3/8	1 Pkg of 10	65152	U-Bolt 3/8 x 3	1 Pkg of 10
65144	U-Bolt 5/16 x 1-3/8	1 Pkg of 10	65153	U-Bolt 3/8 x 3-1/2	1 Pkg of 10
65145	U-Bolt 5/16 x 1-3/4	1 Pkg of 10	65181	Square U-Bolt 2 x 3	1 Pkg of 5
65146	U-Bolt 5/16 x 1-3/4	1 Pkg of 10	65182	Square U-Bolt 2 x 5	1 Pkg of 5
65147	U-Bolt 5/16 x 2	1 Pkg of 10	65184	Square U-Bolt 4 x 3	1 Pkg of 5
65148	U-Bolt 5/16 x 2	1 Pkg of 10	65185	Square U-Bolt 4 x 5	1 Pkg of 5



General Hardware Bulk Merchandiser Continued

PART#	DESCRIPTION	QUANTITY
23050	Stake Rack Hook 3" Left Hand	5 ea.
23051	Stake Rack Hook 3" Right Hand	5 ea.
23054	Stake Rack Eye 5/8" Diam.	5 ea.
65102	Eyebolt 3/16 x 2	2 Pkg of 10
65104	Eyebolt 3/16 x 2-1/2	2 Pkg of 10
65106	Eyebolt 1/4 x 2	2 Pkg of 10
65107	Eyebolt 1/4 x 2-1/2	2 Pkg of 10
65108	Eyebolt 1/4 x 3	2 Pkg of 10
65109	Eyebolt 1/4 x 4	2 Pkg of 10
65110	Eyebolt 1/4 x 5	2 Pkg of 10
65111	Eyebolt 1/4 x 6	2 Pkg of 10
65112	Eyebolt 5/16 x 3-1/4	2 Pkg of 10
65113	Eyebolt 5/16 x 4	2 Pkg of 10
65114	Eyebolt 5/16 x 5	2 Pkg of 10
65115	Eyebolt 5/16 x 6	2 Pkg of 10
65117	Eyebolt 3/8 x 4	2 Pkg of 10
65118	Eyebolt 3/8 x 5	2 Pkg of 10
65119	Eyebolt 3/8 x 6	2 Pkg of 10
65120	Eyebolt 3/8 x 8	2 Pkg of 10
65123	Eyebolt 1/2 x 6	2 Pkg of 10
65124	Eyebolt 1/2 x 8	2 Pkg of 10
66100	Shoulder Eyebolt 1/4 x 2	10 ea.
66101	Shoulder Eyebolt 5/16 x 2-1/4	10 ea.
66102	Shoulder Eyebolt 3/8 x 2-1/2	10 ea.
66103	Shoulder Eyebolt 1/2 x 3-1/4	10 ea.
66104	Shoulder Eyebolt 5/8 X 4	10 ea.
66105	Shoulder Eyebolt 1/4 x 4	5 ea.
66106	Shoulder Eyebolt 5/16 x 4 1/4	10 ea.
66107	Shoulder Eyebolt 3/8 x 6	10 ea.
66108	Shoulder Eyebolt 1/2 x 6	10 ea.
65161	Lagscrew Eyebolt 1/4 x 3-3/4	2 Pkg of 10
65162	Lagscrew Eyebolt 1/4 x 5	2 Pkg of 10
65163	Lagscrew Eyebolt 5/16 x 4	2 Pkg of 10
65164	Lagscrew Eyebolt 5/16 x 6	2 Pkg of 10
65165	Lagscrew Eyebolt 3/8 x 4-1/2	2 Pkg of 10
65166	Lagscrew Eyebolt 3/8 X 8	2 Pkg of 10
65172	Ring & Eyebolt 10 per pkg	1 Pkg of 10
65177	Ring & Lagscrew Eyebolt	1 Pkg of 10
65178	Ring & Mounting Plate	1 Pkg of 10
66178	D-Ring 2 x 1-3/4 H.D.	1 Pkg of 10
66179	D-Ring 2 x 1-7/8 H.D.	1 Pkg of 10
66174	D-Ring 1-1/8 x 7/8	1 Pkg of 10
66412	Steel Ring 7/32 x 1-9/16	1 Pkg of 10
66180	Key Ring - 5/8 I.D., 3/4 O.D.	3 Pkg of 10
66182	Key Ring - 27/32 I.D., 1" O.D.	3 Pkg of 10

PART#	DESCRIPTION	QUANTITY
66184	Key Ring - 1-5/64 ID, 1-1/4 OD	3 Pkg of 10
66423	Tarp Hook 3/8 x 3-1/2	1 Pkg of 10
66424	Tarp Hook 1/4 x 2-1/2	1 Pkg of 10
66419	Snap Link 3/16" - 2" L	2 Pkg of 10
66420	Snap Link 1/4" - 2-3/8" L	2 Pkg of 10
66421	Snap Link 5/16" - 3-1/8" L	2 Pkg of 10
66422	Snap Link 3/8" - 4" L	2 Pkg of 10
66425	Snap Link 7/16" - 4-3/4" L	4 Pkg of 5
66426	Snap Link 1/2" - 5-1/2" L	4 Pkg of 5
66427	Aluminum Snap Hook 3/16 Multi-Color	2 Pkg of 10
66428	Aluminum Snap Link 1/4 Multi-Color	2 Pkg of 10
66429	Aluminum Snap Hook 5/16 Multi-Color	2 Pkg of 10
66700	Carabiner with Magnet 75Lbs	10 ea.
66330	Bull Snap 1 x 4-1/8	2 Pkg of 5
66331	Solid Snap Hook 11/16 x 3-1/2	2 Pkg of 5
66334	Swivel Eye Snap 3/4 x 3-1/4	2 Pkg of 5
66335	Swivel Eye Snap 7/8 x 3-1/2	2 Pkg of 5
66336	Dog Lead Snap 3/8 x 2-1/2	2 Pkg of 5
66339	Trigger Snap 5/8 x 2-1/2	2 Pkg of 5
66344	Trigger Snap 3/4 x 2-3/4	2 Pkg of 5
66340	Bolt Snap 11/16 x 3-3/8	2 Pkg of 5
66342	Double Bolt Snap 7/16 x 3-1/2	2 Pkg of 5
66343	Bolt Snap 3/4 x 3-1/2	2 Pkg of 5
66347	Loop Snap 1 x 2-15/16	2 Pkg of 5
66353	Swivel Loop Snap 1 x 3-1/4	2 Pkg of 5
66230	S-Hook 0.093 x 1	2 Pkg of 10
66232	S-Hook 0.105 x 1-3/32	2 Pkg of 10
66234	S-Hook 0.120 x 1-3/8	2 Pkg of 10
66235	S-Hook 0.162 x 1-1/2	2 Pkg of 10
66236	S-Hook 0.141 x 2-1/8	2 Pkg of 10
66238	S-Hook 0.250 x 2-5/8	2 Pkg of 10
66239	S-Hook 0.188 x 3	2 Pkg of 10
66241	Tarp Strap Hook	2 Pkg of 10
55901	Pulley. Single Fixed 1	5 ea.
55902	Pulley. Single Fixed 1-1/4	5 ea.
55903	Pulley. Single Fixed 1-1/2	5 ea.
55915	Pulley, Single Swivel 3/4	5 ea.
55916	Pulley, Single Swivel 1	5 ea.
55917	Pulley, Single Swivel 1-1/4	5 ea.
55918	Pulley, Single Swivel 1-1/2	5 ea.
55919	Pulley, Single Swivel 2	5 ea.
00619K	S.S. Hardware Merchandiser (Board +Product)	1
00325K	Bronze Bushings Merchandiser (Board +Product)	1
00417K	Forged Turnbuckles merchandiser (Board +Product)	1
00335K	Aluminum Pulleys Merchandiser (Board +Product)	1



Farm Hardware / Chain and Rigging Bulk Merchandiser



Merchandisers

PART#	CONTENTS
00028	Bulk Display Rack Only - 72" x 32" x 24" - 7 shelves
00036K	Full Merchandiser. 164 part #'s, 864 pieces. Includes: 4 sign headers, bulk bin interlocking displays, bin labels and the products listed below:

PART#	DESCRIPTION	QUANTITY	PART#	DESCRIPTION	QUANTITY
66251	Hitch Pin 1/2 x 3-5/8 - Red Handle	5 ea.	66285	Hitch Pin 7/8 x 6-1/4 C/W Chain & Linch Pin	5 ea.
66252	Hitch Pin 5/8 x 4 - Red Handle	5 ea.	66286	Hitch Pin 1 x 6-1/4 C/W Chain & Linch Pin	5 ea.
66253	Hitch Pin 3/4 x 4 - Red Handle	5 ea.	66288	Hitch Pin 1-1/4 x 6-1/4 C/W Chain & Linch Pin	2 ea.
66254	Hitch Pin 7/8 x 4-1/4 - Red Handle	5 ea.	66287	Hitch Pin 1-1/8 x 6-1/4 C/W Chain & Linch Pin	2 ea.
66255	Hitch Pin 1 x 4-3/4 - Red Handle	5 ea.	66250	Hitch Pin 3/8 x 3	5 ea.
66256	Hitch Pin 5/8 x 5-3/4 - Red Handle	5 ea.	66450	Linch Pin 3/16	2 Pkg of 10
66257	Hitch Pin 3/4 x 6-1/2 - Red Handle	5 ea.	66451	Linch Pin 1/4	2 Pkg of 10
66258	Hitch Pin 7/8 x 6-1/2 - Red Handle	5 ea.	66452	Linch Pin 5/16	2 Pkg of 10
66259	Hitch Pin 1 x 7-1/2 - Red Handle	5 ea.	66453	Linch Pin 3/8	2 Pkg of 10
66260	Hitch Pin 1-1/8 x 8-1/2 - Red Handle	5 ea.	66454	Linch Pin 7/16	2 Pkg of 10
66261	Hitch Pin 1-1/4 x 8-1/2 - Red Handle	5 ea.	66455	Linch Pin 7/16	2 Pkg of 10
66263	Hitch Pin 1-1/2 x 8-1/2 - Red Handle	5 ea.	66460	Quick Pin 1/4" x 1-3/8"	2 Pkg of 5
66280	Hitch Pin 1/2 x 4-1/4 C/W Chain & Linch Pin	5 ea.	66461	Quick Pin 1/4" x 1-3/4"	2 Pkg of 5
66281	Hitch Pin 5/8 x 4-1/4 C/W Chain & Linch Pin	5 ea.	66463	Quick Pin 5/16 x 1-3/8	2 Pkg of 5
66282	Hitch Pin 5/8 x 6-1/4 C/W Chain & Linch Pin	5 ea.	66464	Quick Pin 5/16" x 1-3/4"	2 Pkg of 5
66283	Hitch Pin 3/4 x 4-1/4 C/W Chain & Linch Pin	5 ea.	66466	Quick Pin 3/8 x 1-3/8	2 Pkg of 5
66284	Hitch Pin 3/4 x 6-1/4 C/W Chain & Linch Pin	5 ea.	66462	Quick Pin 1/4 x 2-1/2	2 Pkg of 5
67021	Connecting Link 5/16 Grade 80	5 ea.	00031K	DynaTray Merchandiser (Board + Product)	1
67022	Connecting Link 3/8 Grade 80	5 ea.	00527K	Grease Access. Merchandiser (Board + Product)	1
67023	Connecting Link 1/2 Grade 80	5 ea.	00439K	Grade 8 Hitch Pin Merchandiser (Board + Product)	1



Farm Hardware / Chain and Rigging Bulk Merchandiser Continued

PART#	DESCRIPTION	QUANTITY	PART#	DESCRIPTION	QUANTITY
66465	Quick Pin 5/16 x 2-1/2	2 Pkg of 5	66111	Clevis Grab Hook 5/16	5 ea.
66467	Quick Pin 3/8" x 2-1/4"	2 Pkg of 5	66112	Clevis Grab Hook 3/8	5 ea.
66468	Quick Pin 3/8 x 2-1/2	2 Pkg of 5	66113	Clevis Grab Hook 7/16	5 ea.
66470	Safety Pin 1/8 1/8 x3-1/8 x 1-1/16	1 Pkg of 10	66114	Clevis Grab Hook 1/2	5 ea.
66472	Safety Pin 3/16 3/16 x 3-3/8 x 1-1/2	2 Pkg of 5	66115	Clevis Slip Hook 1/4	5 ea.
66474	Safety Pin 1/4 1/4 x 5-1/4 x 1-3/4	2 Pkg of 5	66116	Clevis Slip Hook 5/16	5 ea.
66489	Safety Pin 3/32" 3/32x1-11/16x5/8	1 Pkg of 10	66117	Clevis Slip Hook 3/8	5 ea.
66490	Safety Pin 1/8" 1/8x2-13/16x13/16	1 Pkg of 10	66136	Safety Winch Hook 1/4	5 ea.
66491	Safety Pin 3/16" 3/16 x 3 x 1-1/2	2 Pkg of 5	66145	Eye Hoist Hook 3/4T. C/W Latch	3 ea.
66492	Safety Pin 5/32" 5/32 x3-3/4 x1-1/8	2 Pkg of 5	66146	Eye Hoist Hook 1T. C/W Latch	3 ea.
66000	Anchor Shackle 1/4 1/2 Ton WLL	5 ea.	66147	Eye Hoist Hook 1-1/2T. C/W Latch	3 ea.
66001	Anchor Shackle 5/16 3/4 Ton WLL	5 ea.	67020	Connecting Link 1/4 Grade 80	5 ea.
66002	Anchor Shackle 3/8" 1 Ton WLL	5 ea.			
66003	Anchor Shackle 7/16" 1-1/2 Ton WLL	5 ea.			
66004	Anchor Shackle 1/2" 2 Ton WLL	5 ea.			
66005	Anchor Shackle 5/8" 3-1/4 Ton WLL	5 ea.			
66006	Anchor Shackle 3/4" 4-3/4 Ton WLL	5 ea.			
66007	Anchor Shackle 7/8 6-1/2 Ton WLL	5 ea.			
66008	Anchor Shackle 1 8-1/2 Ton WLL	5 ea.			
66010	Anchor Shackle 1/4 600 lb WLL	5 ea.			
66011	Anchor Shackle 5/16 1/2 Ton WLL	5 ea.			
66012	Anchor Shackle 3/8 3/4 Ton WLL	5 ea.			
66013	Anchor Shackle 1/2 1-1/2 Ton WLL	5 ea.			
66014	Anchor Shackle 5/8 2-1/4 Ton WLL	5 ea.			
66017	Anchor Shackle 7/16 1-1/4 Ton WLL	5 ea.			
66020	Chain Shackle 1/4 1/2 Ton WLL	5 ea.			
66021	Chain Shackle 5/16 3/4 Ton WLL	5 ea.			
66022	Chain Shackle 3/8" 1 Ton WLL	5 ea.			
66023	Chain Shackle 7/16" 1-1/2 Ton WLL	5 ea.			
66024	Chain Shackle 1/2 2 Ton WLL	5 ea.			
66073	Clevis Slip Hook C/W Latch 1/4	5 ea.			
66074	Clevis Slip Hook W/ Latch 5/16	5 ea.			
66075	Clevis Slip Hook C/W Latch 3/8	5 ea.			
66076	Clevis Slip Hook C/W Latch 1/2	5 ea.			
66120	Clevis Grab Hook (Alloy) 1/4	5 ea.			
66121	Clevis Grab Hook (Alloy) 5/16	5 ea.			
66122	Clevis Grab Hook (Alloy) 3/8	5 ea.			
66126	Clevis Grab Hook (Alloy) 7/16	5 ea.			
66127	Clevis Grab Hook (Alloy) 1/2	5 ea.			
66070	Clevis Slip Hook C/W Latch 1/4	5 ea.			
66071	Clevis Slip Hk C/W Latch 5/16	5 ea.			
66072	Clevis Slip Hook C/W Latch 3/8	5 ea.			
66110	Clevis Grab Hook 1/4	5 ea.			





Merchandisers



Trailer Balls Merchandiser

PART#	CONTENTS
00208	Trailer Balls Display Board Only , 12" x 24"
00208K	Full Trailer Balls Merchandiser . 12 part #s, 22 pieces. Includes 00208 display board, 12 pegs (80004) and the products listed below:

PART#	DESCRIPTION	QTY.
11147P	1-7/8" Ball, 1" external thread	2 ea.
11148P	1-7/8" Ball, 3/4" internal thread	2 ea.
11149P	2" Ball, 3/4" internal thread	2 ea.
11151P	1-7/8" Ball, 3/4" external thread	2 ea.
11152P	2" Ball, 3/4" external thread	2 ea.
11153P	2" Ball, 1" external thread	2 ea.
11154P	2-5/16" Ball, 1" external thread	2 ea.
11155P	2-5/16" Ball, 1-1/4" external thread	2 ea.
11155HP	2-5/16" Ball, 1-1/4" external thread, HD	2 ea.
11155XP	2-5/16" Ball, 1-1/4" external thread, HD	2 ea.
11251P	1-7/8" Ball, 3/4" external thread, long shank	1 ea.
11252P	2" Ball, 3/4" external thread, long shank	1 ea.



00024 Compatible



Your Trusted Source.

For more information on these products see the Trailer & Towing Section of the catalogue.



Trailer Couplers Merchandiser

PART#	CONTENTS
00215	Trailer Couplers Display Board Only , 24" x 24"
00215K	Full Trailer Couplers Merchandiser . 9 part #s, 16 pieces. Includes 00215 display board, 10 pegs (80004) and the products listed below:

PART#	DESCRIPTION	QTY.
11156	For 1-7/8" Trailer Balls, 2" Channel	2 ea.
11157	For 1-7/8" Trailer Balls, 2-1/2" Channel	2 ea.
11158	For 1-7/8" Trailer Balls, 3" Channel	2 ea.
11159	For 2" Trailer Balls, 2-1/2" Channel	2 ea.
11159N	For 2" Trailer Balls, 2" Channel	1 ea.
11160	For 2" Trailer Balls, 3" Channel	2 ea.
11162	For 2-5/16" Trailer Balls	1 ea.
66276	Coupler Lock	2 ea.
66277	Coupler and Receiver Lock Set	2 ea.



00024 Compatible



Your Trusted Source.



Trailer & Towing Plan-O-Gram 72"

PART#	CONTENTS
00057	Trailer & Towing Backdrop Only , 48" x 72"
00057K	Full Trailer & Towing Plan-O-Gram . 48 part #s, 89 pieces. Includes 00057 and the products listed below:

PART#	DESCRIPTION	QUANTITY
00210	Ball Mount Display Rack	1 ea.
00637	Jack Rack for Gondola	1 ea.
11154P	Trailer Ball, 2-5/16" x 1", External Thread, Pkgd.	2 ea.
11148P	Trailer Ball, 1-7/8" x 3/4", Internal Thread, Pkgd.	2 ea.
11149P	Trailer Ball, 2" x 3/4", Internal Thread, Pkgd.	2 ea.
11151P	Trailer Ball, 1-7/8" x 3/4", External Thread, Pkgd.	2 ea.
11152P	Trailer Ball, 2" x 3/4", External Thread, Pkgd.	2 ea.
11153P	Trailer Ball, 2" x 1", External Thread, Pkgd.	2 ea.
11156	Trailer Coupler, 1-7/8" x 2"	2 ea.
11157	Trailer Coupler, 1-7/8" x 2-1/2"	2 ea.
11158	Trailer Coupler, 1-7/8" x 3"	2 ea.
11159	Trailer Coupler, 2" x 2-1/2"	2 ea.
11159N	Trailer Coupler, 2" x 2"	2 ea.
11160	Trailer Coupler, 2" x 3"	2 ea.
11170	Trailer Ball Reducer, Bushing 1" to 3/4"	2 ea.
11171	Trailer Ball Reducer, Bushing 1-1/4" to 1"	2 ea.
11304	Hand Winch, 1400 lb	1 ea.
11308	Hand Winch Auto Brake, 1400 lb	1 ea.
11468	Imp. Jack, Top Wind, Tube Mnt, 5000 lb, 10" Lift	1 ea.
11469	Imp. Jack, Top Wind Tube Mnt, 5000 lb, 15" Lift	1 ea.
11471	Imp. Jack, Top Wind, Swivel Mnt, 2000 lb, 15" Lift	1 ea.
11472	Imp. Jack, Side Wind, Tube Mnt, 5000 lb, 15" Lift	1 ea.
11473	Imp. Jack, Side Wind, Tube Mnt, 5000 lb, 10" Lift	1 ea.
11545	Square Tube Jack, Side Wind, 5000 lb, 15" Lift	1 ea.
11579	Ball Mount - Clevis	1 ea.
11591	Ball Mount Kit, 2"	2 ea.
11592	Ball Mount Kit, 2-5/16"	2 ea.
11600	Straight Bar Ball Mount	2 ea.
11601	Ball Mount, 2" Drop	2 ea.



PART#	DESCRIPTION	QUANTITY
11602	Ball Mount, 4" Drop	2 ea.
11607	Triple Ball Mount	2 ea.
11610	Pintle Mount 7-3/8" x 5" 14000 lb	2 ea.
11616	Pintle Hook, 2" Ball	1 ea.
11617	Pintle Hook, 2-5/16" Ball	1 ea.
11618	Pintle Hook, 5 Ton	1 ea.
11619	Pintle Hook, 15 Ton	1 ea.
11670	Ball Mount, 1-1/4" Shank	2 ea.
11671	Ball Mount, 1-1/4" Shank	2 ea.
11690	Ball Mount, 1-1/4", Super Duty	2 ea.
11693	Shackle Ball Mount, 9-3/8"	2 ea.
11786	Hitch Adapter, 2" to 1-1/4"	2 ea.
11787	Hitch Adapter, 1-1/4" to 2"	2 ea.
11785	Hitch Adapter, 2-1/2" to 2"	2 ea.
66270	Pull Pin, 1/2"	4 ea.
66271	Pull Pin, 5/8", 3" Usable Length	4 ea.
66271P	Pull Pin, 5/8", 3" Usable Length - Pkgd.	3 ea.
66274	Hitch Lock Pin, 1/2" x 2-1/2"	2 ea.
66275	Hitch Lock Pin, 5/8" x 3"	2 ea.
66276	Coupler Lock	2 ea.
66277	Coupler & Receiver Lock Set	2 ea.

*Retail hanging pegs not provided



Trailer & Towing Plan-O-Gram 48"

PART#	CONTENTS
01041	Trailer & Towing Backdrop Only , 48" x 48"
01041K	Full Trailer & Towing Plan-O-Gram . 42 part #s, 82 pieces. Includes 01041 and the products listed below:

PART#	DESCRIPTION	QTY.
00210	Ball Mount Display Rack	1 ea.
11154P	Trailer Ball, 2-5/16" x 1", External Thread, Pkgd.	2 ea.
11148P	Trailer Ball, 1-7/8" x 3/4", Internal Thread, Pkgd.	2 ea.
11149P	Trailer Ball, 2" x 3/4", Internal Thread, Pkgd.	2 ea.
11151P	Trailer Ball, 1-7/8" x 3/4", External Thread, Pkgd.	2 ea.
11152P	Trailer Ball, 2" x 3/4", External Thread, Pkgd.	2 ea.
11153P	Trailer Ball, 2" x 1", External Thread, Pkgd.	2 ea.
11156	Trailer Coupler, 1-7/8" x 2"	2 ea.
11157	Trailer Coupler, 1-7/8" x 2-1/2"	2 ea.
11158	Trailer Coupler, 1-7/8" x 3"	2 ea.
11159	Trailer Coupler, 2" x 2-1/2"	2 ea.
11159N	Trailer Coupler, 2" x 2"	2 ea.
11160	Trailer Coupler, 2" x 3"	2 ea.
11170	Trailer Ball Reducer, Bushing 1" to 3/4"	2 ea.
11171	Trailer Ball Reducer, Bushing 1-1/4" to 1"	2 ea.
11304	Hand Winch, 1400 lb	1 ea.
11308	Hand Winch Auto Brake, 1400 lb	1 ea.
11579	Ball Mount - Clevis	2 ea.
11591	Ball Mount Kit, 2"	2 ea.
11592	Ball Mount Kit, 2-5/16"	2 ea.
11600	Straight Bar Ball Mount	2 ea.
11601	Ball Mount, 2" Drop	2 ea.
11602	Ball Mount, 4" Drop	2 ea.
11607	Triple Ball Mount	2 ea.
11616	Pintle Hook, 2" Ball	1 ea.
11617	Pintle Hook, 2-5/16" Ball	1 ea.
11618	Pintle Hook, 5 Ton	1 ea.
11619	Pintle Hook, 15 Ton	1 ea.
11621	Pintle Hook, 20 Ton	1 ea.
11670	Ball Mount, 1-1/4" Shank	2 ea.
11671	Ball Mount, 1-1/4" Shank	2 ea.
11610	Pintle Mount, 7-3/8" x 5" 14000 lb	2 ea.
11690	Ball Mount, 1-1/4", Super Duty	2 ea.
11693	Shackle Ball Mount, 9-3/8"	2 ea.



PART#	DESCRIPTION	QTY.
11786	Hitch Adapter, 2" to 1-1/4"	2 ea.
11787	Hitch Adapter, 1-1/4" to 2"	2 ea.
11785	Hitch Adapter, 2-1/2" to 2"	2 ea.
66270	Pull Pin, 1/2"	4 ea.
66271	Pull Pin, 5/8", 3" Usable Length	4 ea.
66271P	Pull Pin, 5/8", 3" Usable Length - Pkgd.	3 ea.
66274	Hitch Lock Pin, 1/2" x 2-1/2"	2 ea.
66275	Hitch Lock Pin, 5/8" x 3"	2 ea.
66276	Coupler Lock	2 ea.
66277	Coupler & Receiver Lock Set	2 ea.



Merchandisers

! **PlanoGrams do not include gondola or shelves and may not be exactly as illustrated. *Retail hanging pegs not provided





Merchandisers

Trailer & Towing 48"x72" Plan-O-Gram

PART#	CONTENTS	
01046	Trailer & Towing Backdrop Only , 48" x 72"	
01046K	Full Trailer & Towing Plan-O-Gram . 35 part #s, 121 pieces. Includes 01046 and the products listed below:	
PART#	DESCRIPTION	QUANTITY
80010	Push-pin Rivet, Black Plastic	6
00210	Ball Mount Display Rack Semi Gloss Black	1
11156	Trailer Coupler 1-7/8 x 2 1-7/8" Ball 2" Channel 2000lbs	3
11157	Trailer Coupler 1-7/8 x 2-1/2 1-7/8" Ball 2-1/2" Ch. 2000lbs	3
11159	Trailer Coupler 2 x 2-1/2 2" Ball 2-1/2" Channel 3500lbs	3
11160	Trailer Coupler 2 x 3 2" Ball 3" Channel 3500lbs	3
11159N	Trailer Coupler 2 x 2 2" Ball 2" Channel 3500lbs	3
11466	Swing-Way Boat Jack 1200 lb Heavy Duty. 10" Lift	3
11468	TopWind Implement Jack 5000lb Round Tube, 10" Lift, pipe	3
11469	TopWind Implement Jack 5000lb Round Tube, 15" Lift, Pipe	3
11472	SideWind Implement Jack 5000lb Round Tube, 15" Lift, Pipe	3
11473	SideWind Implement Jack 5000lb Round Tube, 10" Lift, Pipe	3
11579	Ball Mount, Clevis 6000Lbs. Hollow Shank	3
11591	Ball Mount Kit 2" 6000lbs Ball Mount, Welded Ball & Pin	3
11592	Ball Mount Kit 2-5/16" 6000lbs Ball Mount, Welded Ball & Pin	3
11600	Straight Bar Ball Mount 5000 lb GTW	3
11601	Ball Mount 2" Drop 6000 lbs	3
11602	Ball Mount 4" Drop 6000 lb.	3
11603	Ball Mount 6" Drop 6000 lb.	3
11606	Triple Ball Mount /W Tow Hook 1-7/8", 2" & 2-5/16" Balls	3
11607	Triple Ball Mount Solid-Square 1-7/8", 2" & 2-5/16" Balls	3
11670	Ball Mount, 1-1/4" Shank 1.25Drop,0.625 Rise,2000lb GTW	3
11671	Ball Mount, 1-1/4 Shank 2.75Drop, 2.125Rise,2000lb GTW	3
11693	Shackle Ball Mnt 9-3/8" Hollow 5/8" Shackle 600 TW, 6000 GTW	3



PART#	DESCRIPTION	QUANTITY
11694	Shackle Ball Mount 10" (Solid) 3/4" Shackle 1000 TW, 10000GTW	3
66270	Pull Pin 1/2, 3" Usable Length C/W EZ-Clip	5
66271	Pull Pin 5/8, 3" Usable Length C/W EZ-Clip	5
66274	Hitch Lock Pin 1/2 x 2-1/2 5,500 lb. Tensile Strength	3
66275	Hitch Lock Pin 5/8 x 3 8,800 lb. Tensile Strength	3
66276	Coupler Lock 1/4" Pin Diameter	3
66277	Coupler & Receiver Lock Set Keyed Alike	3
11147P	Trailer Ball 1-7/8 x 1Ext Pkd 1 x 11147 in black plastic pkg	5
11151P	Trailer Ball 1-7/8 x 3/4 EPkd 1 x 11151 in black plastic pkg	5
11152P	Trailer Ball 2" x 3/4" ExtPkd 1 x 11152 in black plastic pkg	5
11153P	Trailer Ball 2" x 1" Ext. Pkd 1 x 11153 in black plastic pkg	5
11154P	Trailer Ball 2-5/16" x 1"Pkgd 1 x 11154 in black plastic pkg	5
11155P	Trailer Ball 2-5/16 x 1-1/4 Pk 1 x 11155 in black plastic pkg	5



Trailer & Towing 96"x72" Plan-O-Gram

PART#	CONTENTS
01045	Trailer & Towing Backdrop Only , 96" x 72"

01045K Full Trailer & Towing Plan-O-Gram. 59 part #s, 224 pieces. Includes 01045 and the products listed below:

PART#	DESCRIPTION	QUANTITY
65087	Trailer Lock Kit Keyed Alike	3
65088	Wheel Lock Middle Duty	2
65085	Universal Trailer Coupler Lock Light Duty	3
11472	SideWind Implement Jack5000lb Round Tube, 15" Lift, Pipe	3
11473	SideWind Implement Jack5000lb Round Tube, 10" Lift, Pipe	3
11468	TopWind Implement Jack 5000lb Round Tube, 10" Lift, pipe	3
11469	TopWind Implement Jack 5000lb Round Tube, 15" Lift, Pipe	3
11466	Swing-Way Boat Jack 1200 lb Heavy Duty. 10" Lift	3
11147P	Trailer Ball 1-7/8 x 1"	5
11151P	Trailer Ball 1-7/8 x 3/4"	5
11152P	Trailer Ball 2" x 3/4"	5
11153P	Trailer Ball 2" x 1"	5
11154P	Trailer Ball 2-5/16" x 1"	5
11155P	Trailer Ball 2-5/16 x 1-1/4"	5
65086	Universal Trailer Coupler Lock Heavy Duty	3
11988	Plastic Wheel Chock 8"x5"x4-1/4"	3
11492	A-Frame Jack without base 5000lb Cap. 15" Lift Top-Wind	3
11694	Shackle Ball Mount 10" (Solid) 3/4"	3
52700	12V Power Jack - 4,000Lbs	2
11617	Pintle Hook 2-5/16" Ball 16000 lb	2
11670	Ball Mount, 1-1/4"	3
11610	Pintle Mount 7-3/8" x 5"	3
11671	Ball Mount, 1-1/4"	3
11693	Shackle Ball Mnt 9-3/8"	3
11605	Dual Ball Mount 2 & 2-5/16"	3
11716	Pintle Combination Hitch 1-pc 2" Ball. 12000 lb GTW	2
11717	Pintle Combination Hitch 1-pc 2-5/16"	2
11606	Triple Ball Mount w/ Tow Hook 1-7/8", 2"	2
11603	Ball Mount 6" Drop 6000 lb.	3
11984	Wheel Chock- 7-1/2 x 6 x 3-3/4	3
11601	Ball Mount 2" Drop 6000 lbs	3
11602	Ball Mount 4" Drop 6000 lb.	3
11985	Wheel Chock -10-5/8 x7x 4-1/2	3
11986	Wheel Chock - 8 x 6 x 10	3
11600	Straight Bar Ball Mount 5000 lb GTW	3



PART#	DESCRIPTION	QUANTITY
11579	Ball Mount, Clevis 6000Lbs. Hollow Shank	3
66275	Hitch Lock Pin 5/8 x 3 8,800 lb. Tensile Strength	3
11591	Ball Mount Kit 2" 6000lbs Ball Mount, Welded Ball & Pin	3
11592	Ball Mount Kit 2-5/16" 6000lbs Ball Mount, Welded Ball & Pin	3
66270	Pull Pin 1/2, 3" Usable Length C/W EZ-Clip	5
66271	Pull Pin 5/8, 3" Usable Length C/W EZ-Clip	5
11160	Trailer Coupler 2 x 3 2" Ball 3" Channel 3500lbs	3
11159N	Trailer Coupler 2 x 2 2" Ball 2" Channel 3500lbs	3
11159	Trailer Coupler 2 x 2-1/2 2" Ball 2-1/2" Channel 3500lbs	3
11156	Trailer Coupler 1-7/8 x 2 1-7/8" Ball 2" Channel 2000lbs	3
11157	Trailer Coupler 1-7/8 x 2-1/2 1-7/8" Ball 2-1/2" Ch. 2000lbs	3
11171	Trailer Ball Reducer Bushing Reduce from 1-1/4" to 1"	3
27004	4 Pole Flat Connector 18g Wire 12" Male 48" Female 18" Ground	3
27006	4 Pole Flat Connector 12"	3
27008	4 Flat Connect, 25ft Loop 18ft Male End, 5ft Female End	3
27048	7-Way Socket, Plastic Housing Red Reflector, Vehicle Side	3
27050	7-Way Plug in Plastic Housing Trailer Side	3
27084	Trailer Adapter, 7-Way Blade To 4-Way Flat	3
27096	7-Way Blade Tester With 6 LEDs Indicator	3
27098	Breakaway Switch 4ft 16ga Wire Metal Bracket Included	3
66266	E-Z Clip 0.148"	40
66274	Hitch Lock Pin 1/2 x 2-1/2"	3
66276	Coupler Lock 1/4"	3
66277	Coupler & Receiver Lock Set Keyed Alike	3
HB1525	Plastic Bin Blue - 10" x 5-7/8" x 4-3/4"	3
00210	Ball Mount Display Rack Semi Gloss Black	1



Merchandisers



! **PlanoGrams do not include gondola or shelves and may not be exactly as illustrated. *Retail hanging pegs not provided



Merchandisers

Tow-Pro Trailer & Towing Merchandisers

1.877.453.3964

1.877.453.5050

www.dynaline.com

orders@dynaline.com



Merchandisers



Ball Mount Rack

PART#	CONTENTS
00210	Ball Mount Rack Only , 48" x 15" x 10"
00210K	Full Ball Mount Rack Merchandiser . 15 part #s, 30 pieces. Includes the display and an assortment of our most popular ball mounts and receivers and the products listed below:

PART#	DESCRIPTION	QUANTITY
11579	Clevis Ball Mount 5000lb	2 ea.
11591	Ball Mount Kit 2	2 ea.
11592	Ball Mount Kit 2-5/16	2 ea.
11600	Straight Bar Ball Mount	2 ea.
11601	Ball Mount 2" Drop	2 ea.
11602	Ball Mount 4" Drop	2 ea.
11607	Triple Ball Mount	2 ea.
11670	Ball Mount, 1-1/4" Shank	2 ea.

PART#	DESCRIPTION	QUANTITY
11671	Ball Mount, 1-1/4 Shank	2 ea.
11610	Pintle Mount, 7-3/8" x 5" 14000 lb	2 ea.
11690	Ball Mount 1-1/4" Super Duty, 3" Drop	2 ea.
11693	Shackle Ball Mount	2 ea.
11786	Hitch Adapter - 2 to 1-1/4	2 ea.
11787	Hitch Adapter - 2 to 1-1/4	2 ea.
11785	Hitch Adapter, 2-1/2" to 2"	2 ea.

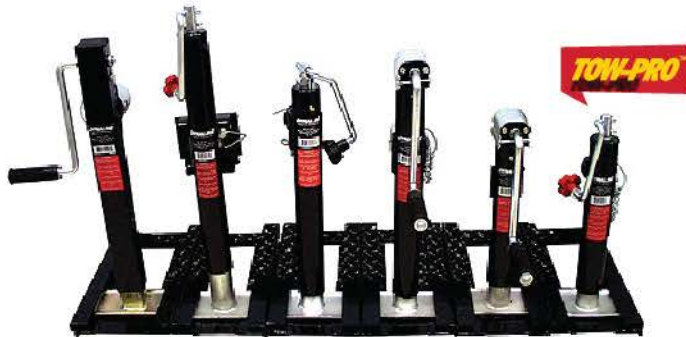

Jack Rack

Jack Rack Merchandiser can be placed on floor or bottom of a gondola shelf. Fits regular 4 ft. Gondola Shelf, 18" deep.

PART#	CONTENTS
00637	Jack Stand Bracket Only , 1 piece display (bolts not included)
00637K	Full Jack Rack Merchandiser . 6 part #s, 12 pieces. Includes 00637 Jack Rack for Gondola shelf, labels and the products listed below:

PART#	DESCRIPTION	QTY.
11468	Implement Jack, Tube Mount, Top Wind, 5000 lb, 10" Lift	2 ea.
11469	Implement Jack, Tube Mount, Top Wind, 5000 lb, 15" Lift	2 ea.
11471	Swivel Bracket Mount, 2000 lb, 15" Lift	2 ea.
11472	Implement Jack, Tube Mount, Side Wind, 5000 lb, 15" Lift	2 ea.
11473	Implement Jack, Tube Mount, Side Wind, 5000 lb, 10" Lift	2 ea.
11545	Tube Mount, Side Wind, Square Tube, 5000 lb, 15" Lift	2 ea.



Funnel Tree Merchandiser

PART#	CONTENTS
00628	Funnel Tree Display Only. 3 shelves 36", 32" and 28". 86" high. Includes Header Sign.
00628K	Funnel Tree Merchandiser. 26 part #s, 75 pieces. Includes Funnel Tree rack & header sign, and the product listed below:

FEATURES:

1. Three shelves and hangers on the bottom
2. Comes with specific signage for each level
3. Stocked with a mix of the most popular products
4. Merchandises awkwardly-shaped funnels attractively

BENEFITS:

1. Boost sales by making the funnels more appealing and easier to shop
2. Options for positioning depending on your floor space. Fits in a corner or as a stand-alone, 360-degree merchandiser
3. Freshen up your store and improve the shopping experience
4. Save time and avoid stock outages with a cleanly merchandised products mix



Merchandisers

PART NO.	DESCRIPTION	QUANTITY
13003	Funnel With Filter 3" Diameter. 6 Oz C/W Filter	3
13005	Funnel With Filter 5" Diameter. 24 Oz C/W Filter	3
13015	Funnel Anti-Splash 5" Diameter. 24 Oz C/W Filter	3
13030	Oiler with 3" Nozzle 6 oz. Capacity	3
13031	Oiler with 3" Nozzle 10 oz. Capacity	3
13503	3pc Funnel Set 4", 5" and 6"	3
13504	Funnel Multi-Purpose 4" Diameter. 8 Oz	3
13505	5" Funnel without Filter 14 oz. Capacity	3
13506	Funnel Multi-Purpose 6" Diameter. 32 Oz	3
13610	Pump Oiler 10.6oz (300cc) Standard Thumb Type	3
13617	Pump Oiler 17oz (500cc) Standard Thumb Type. 1 Pint	3
14025	Measuring Container - 2.5 L	3
14045	Measuring Container - 4.5 L	3
14045X	Measuring Container - 4.5L With Detachable Lid	3

PART NO.	DESCRIPTION	QUANTITY
14140	Metal Measurer W/ Flex Spout 4 quarts	3
13007	Easy Flow Funnel Offset w/4-3/4 x 3-5/8 Opening	3
13008	Funnel W/ Filter Automotive 8 Diameter. 120 Oz C/W Filter	3
13009	Funnel With Filter 9 9 Diameter. 144 Oz C/W Filter	3
13019	Funnel Anti-Splash 9" 9" Diameter. 144 Oz C/W Filter	3
13508	Funnel Multi-Purpose 8" Diameter. 120 Oz	3
14014	Transmission Funnel. Metallic 5-1/2" Dia. 14" Spout. Screen	3
14015	2-in-1 Flexible Spout Funnel Plastic. C/W mesh filter	3
14035	Dirt Free Funnel 15" 5/8" Dia. x 15" Long - Yellow	3
14022	Drain Pan - 16 Litres 23 L x 18 W x 5-1/2 D	2
14026	Sealable Drain Pan - 10L	2
14017	Transmission Funnel Plastic 16" Long Spout	4





Merchandisers

S.A.E. O-Rings Merchandiser

PART#	CONTENTS
00318	O-Rings Display Board Only, 24" x 24"
00318K	Full O-Rings Merchandiser. 102 part #s, 1030 pieces. Includes 00318 display board, 110 cornice hooks (65043) and products listed below:

PART#	REF#	QUANTITY	PART#	REF#	QUANTITY
54006	006	1 pkg. of 15	54126	126	1 pkg. of 10
54007	007	1 pkg. of 15	54127	127	1 pkg. of 10
54008	008	1 pkg. of 15	54128	128	1 pkg. of 10
54009	009	1 pkg. of 15	54129	129	1 pkg. of 10
54010	010	1 pkg. of 15	54130	130	1 pkg. of 10
54011	011	1 pkg. of 15	54131	131	1 pkg. of 10
54012	012	1 pkg. of 15	54132	132	1 pkg. of 10
54013	013	1 pkg. of 10	54133	133	1 pkg. of 10
54014	014	1 pkg. of 10	54134	134	1 pkg. of 10
54015	015	1 pkg. of 10	54135	135	1 pkg. of 10
54016	016	1 pkg. of 10	54136	136	1 pkg. of 10
54017	017	1 pkg. of 10	54137	138	1 pkg. of 10
54018	018	1 pkg. of 10	54138	138	1 pkg. of 10
54019	019	1 pkg. of 10	54139	139	1 pkg. of 10
54020	020	1 pkg. of 10	54140	140	1 pkg. of 10
54021	021	1 pkg. of 10	54141	141	1 pkg. of 10
54022	022	1 pkg. of 10	54142	142	1 pkg. of 10
54023	023	1 pkg. of 10	54143	143	1 pkg. of 10
54024	024	1 pkg. of 10	54144	144	1 pkg. of 10
54025	025	1 pkg. of 10	54145	145	1 pkg. of 10
54026	026	1 pkg. of 10	54146	146	1 pkg. of 10
54027	027	1 pkg. of 10	54147	147	1 pkg. of 10
54028	028	1 pkg. of 10	54148	148	1 pkg. of 10
54110	110	1 pkg. of 15	54149	149	1 pkg. of 10
54111	111	1 pkg. of 15	54210	210	1 pkg. of 10
54112	112	1 pkg. of 15	54211	211	1 pkg. of 10
54113	113	1 pkg. of 15	54212	212	1 pkg. of 10
54114	114	1 pkg. of 15	54213	213	1 pkg. of 10
54115	115	1 pkg. of 15	54214	214	1 pkg. of 10
54116	116	1 pkg. of 15	54215	215	1 pkg. of 10
54117	117	1 pkg. of 10	54216	216	1 pkg. of 10
54118	118	1 pkg. of 10	54217	217	1 pkg. of 10
54119	119	1 pkg. of 10	54218	218	1 pkg. of 10
54120	120	1 pkg. of 10	54219	219	1 pkg. of 10
54121	121	1 pkg. of 10	54220	220	1 pkg. of 10
54122	122	1 pkg. of 10	54221	221	1 pkg. of 10
54123	123	1 pkg. of 10	54222	222	1 pkg. of 10
54124	124	1 pkg. of 10	54223	223	1 pkg. of 10
54125	125	1 pkg. of 10	54224	224	1 pkg. of 10

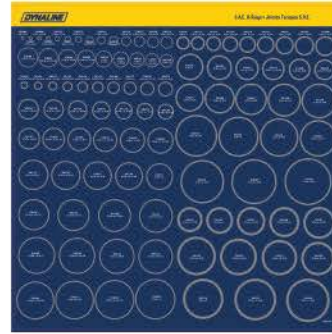

Reference Chart Available
 See end of catalogue



PART#	REF#	QUANTITY
54225	225	1 pkg. of 10
54226	226	1 pkg. of 10
54227	227	1 pkg. of 10
54228	228	1 pkg. of 10
54229	229	1 pkg. of 10
54230	230	1 pkg. of 10
54231	231	1 pkg. of 10
54232	232	1 pkg. of 10
54233	233	1 pkg. of 10
54234	234	1 pkg. of 10
54235	235	1 pkg. of 10
54236	236	1 pkg. of 10
54325	325	1 pkg. of 5
54326	326	1 pkg. of 5
54327	327	1 pkg. of 5
54328	328	1 pkg. of 5
54329	329	1 pkg. of 5
54330	330	1 pkg. of 5
54331	331	1 pkg. of 5
54332	332	1 pkg. of 5
54333	333	1 pkg. of 5
54334	334	1 pkg. of 5
54335	335	1 pkg. of 5
54336	336	1 pkg. of 5



O-Ring Tilt Bins Merchandiser

PART#	CONTENTS
00716K	Full O-Rings Tilt Bin Merchandiser. Dimensions: 23-5/8" x 3-5/8" x 36". 68 part #s, 735 pieces. Includes Tilt Bins, assembly hardware and the products listed below:

PART#	DESCRIPTION	QTY.
54006	O-Ring 006	1 pkg. of 15
54007	O-Ring 007	1 pkg. of 15
54008	O-Ring 008	1 pkg. of 15
54009	O-Ring 009	1 pkg. of 15
54010	O-Ring 010	1 pkg. of 15
54011	O-Ring 011	1 pkg. of 15
54012	O-Ring 012	1 pkg. of 15
54013	O-Ring 013	1 pkg. of 10
54014	O-Ring 014	1 pkg. of 10
54015	O-Ring 015	1 pkg. of 10
54016	O-Ring 016	1 pkg. of 10
54017	O-Ring 017	1 pkg. of 10
54018	O-Ring 018	1 pkg. of 10
54019	O-Ring 019	1 pkg. of 10
54020	O-Ring 020	1 pkg. of 10
54021	O-Ring 021	1 pkg. of 10
54022	O-Ring 022	1 pkg. of 10
54023	O-Ring 023	1 pkg. of 10
54024	O-Ring 024	1 pkg. of 10
54025	O-Ring 025	1 pkg. of 10
54026	O-Ring 026	1 pkg. of 10
54027	O-Ring 027	1 pkg. of 10
54028	O-Ring 028	1 pkg. of 10
54110	O-Ring 110	1 pkg. of 15
54111	O-Ring 111	1 pkg. of 15
54112	O-Ring 112	1 pkg. of 15
54113	O-Ring 113	1 pkg. of 15
54114	O-Ring 114	1 pkg. of 15
54115	O-Ring 115	1 pkg. of 15
54116	O-Ring 116	1 pkg. of 15
54117	O-Ring 117	1 pkg. of 10
54118	O-Ring 118	1 pkg. of 10
54119	O-Ring 119	1 pkg. of 10
54120	O-Ring 120	1 pkg. of 10
54121	O-Ring 121	1 pkg. of 10
54122	O-Ring 122	1 pkg. of 10
54123	O-Ring 123	1 pkg. of 10
54124	O-Ring 124	1 pkg. of 10
54125	O-Ring 125	1 pkg. of 10



Reference Chart Available
See end of catalogue

PART#	DESCRIPTION	QTY.
54128	O-Ring 128	1 pkg. of 10
54210	O-Ring 210	1 pkg. of 10
54211	O-Ring 211	1 pkg. of 10
54212	O-Ring 212	1 pkg. of 10
54213	O-Ring 213	1 pkg. of 10
54214	O-Ring 214	1 pkg. of 10
54215	O-Ring 215	1 pkg. of 10
54216	O-Ring 216	1 pkg. of 10
54217	O-Ring 217	1 pkg. of 10
54218	O-Ring 218	1 pkg. of 10
54219	O-Ring 219	1 pkg. of 10
54220	O-Ring 220	1 pkg. of 10
54221	O-Ring 221	1 pkg. of 10
54222	O-Ring 222	1 pkg. of 10
54223	O-Ring 223	1 pkg. of 10
54224	O-Ring 224	1 pkg. of 10
54225	O-Ring 225	1 pkg. of 10
54226	O-Ring 226	1 pkg. of 10
54227	O-Ring 227	1 pkg. of 10
54228	O-Ring 228	1 pkg. of 10
54229	O-Ring 229	1 pkg. of 10
54230	O-Ring 230	1 pkg. of 10
54231	O-Ring 231	1 pkg. of 10
54232	O-Ring 232	1 pkg. of 10
54235	O-Ring 235	1 pkg. of 10
54236	O-Ring 236	1 pkg. of 10
54325	O-Ring 325	1 pkg. of 5
54326	O-Ring 326	1 pkg. of 5
54327	O-Ring 327	1 pkg. of 5
TF306	Tilt Bin 6 comp.	6 ea.
TF308	Tilt Bin 8 comp.	4 ea.



Grease Accessories Merchandiser

PART#	CONTENTS
00527	Grease Accessories Display Board Only, 24" x 24"

00527K Full Grease Accessories Merchandiser .
41 part #s, 149 pieces. Includes 00527 display board, 41 pegs (80004) and the products listed below:

PART#	DESCRIPTION	QUANTITY
00163	S.A.E. Grease Fittings Dynakit	3 ea.
00181	Metric Grease Fittings Dynakit	2 ea.
00182	Drive-In Grease Fittings Dynakit	2 ea.
11077	Grease Gun Holder Bracket	2 ea.
11122	Grease Injectors Dynapak, (3 pcs.), 10 Ga.	3 pkgs. of 3
11140	Grease Hose, Plastic, 12", packaged	2 ea.
11141	Grease Hose, Plastic, 18", packaged	4 ea.
11080A	Needle Tip Dispenser	3 ea.
11075A	Needle Nose Dispenser, 1-1/2"	4 ea.
11081A	90° Angle Grease Coupler	2 ea.
11100A	S.A.E. Grease Fittings Dynapak, 10 x 11100	6 pkgs. of 10
11102A	S.A.E. Grease Fittings Dynapak, 5 x 11102	4 pkgs. of 5
11104A	S.A.E. Grease Fittings Dynapak, 5 x 11104	4 pkgs. of 5
11105A	S.A.E. Grease Fittings Dynapak, 10 x 11105	4 pkgs. of 10
11106A	S.A.E. Grease Fittings Dynapak, 10 x 11106	4 pkgs. of 10
11107A	S.A.E. Grease Fittings Dynapak, 5 x 11107	4 pkgs. of 5
11109A	S.A.E. Grease Fittings Dynapak, 5 x 11109	4 pkgs. of 5
11110A	S.A.E. Grease Fittings Dynapak, 5 x 11110	4 pkgs. of 5
11112A	S.A.E. Grease Fittings Dynapak, 5 x 11112	4 pkgs. of 5
11113A	S.A.E. Grease Fittings Dynapak, 5 x 11113	4 pkgs. of 5
11114A	Metric Grease Fittings Dynapak, 5 x 11114	4 pkgs. of 5
11115A	Metric Grease Fittings Dynapak, 5 x 11115	4 pkgs. of 5
11116A	Metric Grease Fittings Dynapak, 5 x 11116	4 pkgs. of 5
11117A	Metric Grease Fittings Dynapak, 5 x 11117	4 pkgs. of 5
11118A	Metric Grease Fittings Dynapak, 5 x 11118	4 pkgs. of 5
11119A	Metric Grease Fittings Dynapak, 5 x 11119	4 pkgs. of 5



PART#	DESCRIPTION	QUANTITY
11120A	Metric Grease Fittings Dynapak, 5 x 11120	4 pkgs. of 5
11121A	Grease Coupler Dynapak, 1/8" NPT	6 ea.
11123A	Grease Injector, 18 Ga.	3 ea.
11124A	Grease Injectors (2 sizes: 18 Ga. & 21 Ga.)	3 pkgs. of 2
11125A	Grease Couplers, 1/8" NPT, Heavy Duty	4 ea.
11126A	Metric Grease Fittings Dynapak, 5 x 11126	4 pkgs. of 5
11127A	Metric Grease Fittings Dynapak, 5 x 11127	4 pkgs. of 5
11131A	Drive-In Grease Fittings Dynapak, 5 x 11131	4 pkgs. of 5
11132A	Drive-In Grease Fittings Dynapak, 5 x 11132	4 pkgs. of 5
11133A	Drive-In Grease Fittings Dynapak, 5 x 11133	4 pkgs. of 5
11134A	Drive-In Grease Fittings Dynapak, 5 x 11134	4 pkgs. of 5
11135A	Drive-In Grease Fittings Dynapak, 5 x 11135	3 pkgs. of 10
11136A	Drive-In Grease Fittings Dynapak, 5 x 11136	3 pkgs. of 10
11142A	Grease Hose, Rubber, 12"	2 ea.
11143A	Grease Hose, Rubber, 18"	4 ea.



Merchandisers



Lubrication Plan-O-Gram

PART#	CONTENTS
01031	Lubrication Backdrop Only , 48" x 48"
01031K	Full Lubrication Plan-O-Gram . 53 part #s, 168 pieces. Includes 01031 and the products listed below:

PART#	DESCRIPTION	QUANTITY
00163	S.A.E. Grease Fitting Dynakit, 40 Pcs.	2 ea.
00181	Metric Grease Fittings Dynakit, 50 Pcs.	2 ea.
00182	Drive-In Grease Fittings Dynakit, 50 Pcs.	2 ea.
11066	Professional Pistol Grease Gun	2 ea.
11073	Multi-Purpose Lithium Grease, 3 X 85G	2 Pkg. of 3
11076	Needle Nose Adapter, 4"	2 ea.
11077	Grease Gun Holder Bracket	2 ea.
11091	Lever Action Pail Pump	2 ea.
11122	Grease Injector, 18Ga	3 Pkg. of 3
11140	Grease Hose 12"	3 ea.
11141	Grease Hose 18"	3 ea.
11094A	Rotary Barrel Pump Delivers 1 gal	2 ea.
11071A	360° Swivel Coupler 1/8" NPT	3 ea.
11075A	Needle Nose Dispenser, 1-1/2"	3 ea.
11080A	Needle Nose Adapter, Fine	3 ea.
11081A	90° Angle Grease Coupler	2 ea.
11082C	Premium Lever Grease Gun, H.D.	2 ea.
11084A	Pistol Grease Gun, C/W Hose, H.D.	2 ea.
11085A	Lever Grease Gun, H.D.	2 ea.
11087A	Heavy Duty Pistol Grease Gun	2 ea.
11090A	Suction Gun	2 ea.
11092A	Lever Action Barrel Pump	2 ea.
11100A	Dynapak Grease Fitting, 1/8" Straight	4 Pkg. of 10
11102A	Dynapak Grease Fitting, 1/8" 45°	4 Pkg. of 5
11104A	Dynapak Grease Fitting, 1/8" 90°	4 Pkg. of 5
11105A	Dynapak Grease Fitting, 1/4" Straight	4 Pkg. of 5
11106A	Dynapak Grease Fitting, 1/4" Long	4 Pkg. of 10
11107A	Dynapak Grease Fitting, 1/4" 45°	4 Pkg. of 5
11109A	Dynapak Grease Fitting, 1/4" 90°	4 Pkg. of 5
11110A	Dynapak Grease Fitting, 1/4" Straight	4 Pkg. of 5
11112A	Dynapak Grease Fitting, 5/16" Straight	4 Pkg. of 5
11113A	Dynapak Grease Fitting, 3/8" Straight	4 Pkg. of 5
11114A	Dynapak Grease Fitting, M6 X 1 Straight	4 Pkg. of 5
11115A	Dynapak Grease Fitting, M6 X 1 45°	4 Pkg. of 5
11116A	Dynapak Grease Fitting, M6 X 1 90°	4 Pkg. of 5



PART#	DESCRIPTION	QUANTITY
11117A	Dynapak Grease Fitting, M8 X 1 Straight	4 Pkg. of 5
11118A	Dynapak Grease Fitting, M8 X 1 45°	4 Pkg. of 5
11119A	Dynapak Grease Fitting, M8 X 1 90°	4 Pkg. of 5
11120A	Dynapak Grease Fitting, M10 X 1 Str.	4 Pkg. of 5
11121A	Dynapak Grease Coupler, 6000 Psi	3 ea.
11123A	Grease Injector, 18Ga	3 ea.
11124A	Grease Injector, (1) 18Ga, (1) 21Ga	3 Pkg. of 2
11125A	Heavy Duty Grease Coupler	3 ea.
11126A	Dynapak Grease Fitting, M10 X 1, 45°	3 Pkg. of 5
11127A	Dynapak Grease Fitting, M10 X 1, 90°	4 Pkg. of 5
11131A	Dynapak Grease Fitting, 3/16" Drive-In	4 Pkg. of 5
11132A	Dynapak Grease Fitting, 1/4" Drive-In	4 Pkg. of 5
11133A	Dynapak Grease Fitting, 5/16" Drive-In	4 Pkg. of 5
11134A	Dynapak Grease Fitting, 3/8" Drive-In	4 Pkg. of 5
11135A	S.A.E. Grease Fittings, Dynapak	4 Pkg. of 10
11136A	Metric Grease Fittings, Dynapak	4 Pkg. of 10
11142A	Grease Hose 12"	3 ea.
11143A	Grease Hose 18"	3 ea.



Merchandisers





Merchandisers

Funnels & Lubrication Merchandiser

PART#	CONTENTS
01032	Funnels and Lubrication Backdrop Only , 48" x 48"
01032K	Full Funnels and Lubrication Plan-o-gram . 42 part #s, 120 pieces. Includes 01032 and the products listed below:

PART#	DESCRIPTION	QTY.
00163	S.A.E. Grease Fittings Dynakit	2 ea.
00181	Metric Grease Fittings Dynakit	2 ea.
00182	Drive-In Grease Fittings Dynakit	2 ea.
11077	Grease Gun Holder Bracket	2 ea.
11141	Grease Hose 18", packaged	3 ea.
13007	Easy Flow Funnel, 4-3/4 x 3-5/8 Opening	2 ea.
13003	Funnel With Filter, 3" diameter	2 ea.
13005	Funnel With Filter, 5" diameter	2 ea.
13008	Funnel With Filter Auto, 8" diameter	2 ea.
13009	Funnel With Filter, 9" diameter	2 ea.
14014	Metal Transmission Funnel, 6-1/2" diameter	2 ea.
14045	Measuring Container - 4.5 L	2 ea.
11080A	Needle Tip Dispenser	3 ea.
11081A	90 Degree Grease Coupler	3 ea.
11082C	Grease Gun - Lever - H.D.	2 ea.
11084A	Grease Gun Pistol, C/W Hose	2 ea.
11085A	Grease Gun - Lever	2 ea.
11087A	Grease Gun - Pistol	2 ea.
11090A	Fluid Suction Gun	2 ea.
11091	Oil Pump	1 ea.
11092A	Lever Action Barrel Pump	2 ea.
11100A	Dynapak - 10 x 11100	4 pkgs. of 10
11102A	Dynapak - 5 x 11102	4 pkgs. of 5
11104A	Dynapak - 5 x 11104	4 pkgs. of 5
11105A	Dynapak - 10 x 11105	4 pkgs. of 5
11106A	Dynapak - 10 x 11106	4 pkgs. of 10
11107A	Dynapak - 5 x 11107	4 pkgs. of 5
11109A	Dynapak - 5 x 11109	4 pkgs. of 5
11110A	Dynapak - 5 x 11110	4 pkgs. of 5
11113A	Dynapak - 5 x 11113	4 pkgs. of 5
11120A	Dynapak - 5 x 11120 (Metric)	4 pkgs. of 5
11121A	Grease Coupler Dynapak	3 ea.
11124A	Grease Injectors, 18 & 21 Gauge	3 ea.

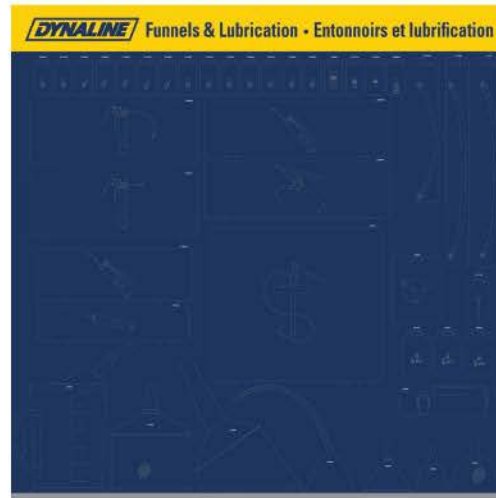

PART#	DESCRIPTION	QTY.
11123A	Grease Injector 18GA	3 ea.
11125A	Dynapak - 1 x 11125	4 ea.
11131A	Dynapak - 5 x 11131	4 pkgs. of 5
11133A	Dynapak - 5 x 11133	4 pkgs. of 5
11134A	Dynapak - 5 x 11134	4 pkgs. of 5
11135A	S.A.E. Grease Fitting Assortment	3 pkgs. of 10
11142A	Grease Hose, 12", Packaged	3 ea.
11143A	Grease Hose, 18", Packaged	3 ea.





Plastic Funnels & Measures Merchandiser

PART#	CONTENTS
00626	Plastic Funnels & Measurer's Backdrop Only , 48" x 48".
00626K	Full Plastic Funnels & Measures Plan-o-gram . 16 part #s, 93 pieces. Includes 00626 and the products listed below:

PART#	DESCRIPTION	QTY.
13003	Funnel with Filter, 3"	10 ea.
13005	Funnel with Filter, 5"	12 ea.
13008	Automotive with Filter	8 ea.
13009	Funnel with Filter, 9"	4 ea.
13015	Anti-Splash Funnel, 5"	10 ea.
13019	Anti-Splash Funnel, 9"	5 ea.
13504	Multi-Purpose Funnel, 4"	10 ea.
13505	Multi-Purpose Funnel, 5"	10 ea.
13007	Easy Flow Funnel, 4-3/4 x 3-5/8 Opening	2 ea.
13508	Multi-Purpose Funnel, 8"	10 ea.
14015	2-in-1 Flexible Spout	2 ea.
14017	Transmission Funnel (plastic), 16" spout	2 ea.
14022	Drain Pan, 16 L	2 ea.
14023	Drain Pan, 24 L	2 ea.
14025	Measurer, 2.5 L	2 ea.
14045	Measurer, 4.5 L	2 ea.



Merchandisers



For more information on these products see the Lubrication Section of the catalogue.



! **PlanoGrams do not include gondola or shelves and may not be exactly as illustrated. *Retail hanging pegs not provided



Lubrication Plan-O-Gram

PART#	CONTENTS
00063	Lubrication Backdrop Only , 48" x 72".
00063K	Full Lubrication Plan-o-gram . 58 part #s, 173 pieces. Includes 00063 and the products listed below:

PART#	DESCRIPTION	QTY.
00163	S.A.E. Grease Fitting Dynakit	2 ea.
00181	Metric Grease Fittings Dynakit,	2 ea.
00182	Drive-in Grease Fittings Dynakit	2 ea.
11055	Rechargeable Grease Gun Kit, 24V Li-ion	1 ea.
11066	Professional Pistol Grease Gun	2 ea.
11073	Multi-Purpose Lithium Grease, 3 X 85G	2 pkg. of 3
11076	Needle Nose Adapter, 4"	3 ea.
11077	Grease Gun Holder Bracket	1 ea.
11078	Replacement Grease Gun Pipe, 5 1/2"	3 ea.
11091	Lever Action Pail Pump	2 ea.
11093	Fluid Transfer Pump	2 ea.
11122	Grease Injector, 18 Ga.	3 pkg. of 3
11140	Grease Hose, 12"	3 ea.
11141	Grease Hose, 18"	3 ea.
13000	Tube Tote - Grease	1 ea.
14022	Drain Pan - 16 Litres	1 ea.
14023	Drain Pan - 24 Litres	1 ea.
11071A	360° Swivel Coupler, 1/8" NPT	2 ea.
11075A	Needle Nose Dispenser, 1 1/2"	3 ea.
11080A	Needle Nose Adapter, Fine	3 ea.
11081A	90° Angle Grease Coupler	3 ea.
11082C	Professional Lever Grease Gun	2 ea.
11084A	Pistol Grease Gun, C/W hose, heavy duty	2 ea.
11087A	Heavy Duty Pistol Grease Gun	2 ea.
11089A	Mini Pistol Grease Gun	2 ea.
11090A	Suction Gun	2 ea.
11094A	Rotary Barrel Pump	2 ea.
11100A	Dynapak Grease Fitting, 1/8"	4 pkg. of 10
11102A	Dynapak Grease Fitting, 1/8", 45°	4 pkg. of 5
11104A	Dynapak Grease Fitting, 1/8", 90°	4 pkg. of 5
11105A	Dynapak Grease Fitting, 1/4", Straight	4 pkg. of 5
11106A	Dynapak Grease Fitting, 1/4", Long	4 pkg. of 10
11107A	Dynapak Grease Fitting, 1/4", 45°	4 pkg. of 5
11109A	Dynapak Grease Fitting, 1/4", 90°	4 pkg. of 5
11110A	Dynapak Grease Fitting, 1/4", Straight	4 pkg. of 5



PART#	DESCRIPTION	QTY.
11112A	Dynapak Grease Fitting, 5/16", Straight	4 pkg. of 5
11113A	Dynapak Grease Fitting, 3/8" Straight	4 pkg. of 5
11114A	Dynapak Grease Fitting, M6 X 1 Straight	4 pkg. of 5
11115A	Dynapak Grease Fitting, M6 X 1 45°	4 pkg. of 5
11116A	Dynapak Grease Fitting, M6 X 1 90°	4 pkg. of 5
11117A	Dynapak Grease Fitting, M8 X 1 Straight	4 pkg. of 5
11118A	Dynapak Grease Fitting, M8 X 1 45°	4 pkg. of 5
11119A	Dynapak Grease Fitting, M8 X 1 90°	4 pkg. of 5
11120A	Dynapak Grease Fitting, M10 X 1 Straight	4 pkg. of 5
11121A	Dynapak Grease Coupler, 6000 PSI	3 ea.
11123A	Grease Injector, 18 Ga	3 ea.
11124A	Grease Injector (1)18 Ga, (1) 21 Ga	3 pkg. of 2
11125A	Heavy Duty Grease Coupler	3 pkg.
11126A	Dynapak Grease Fitting, M10 X 1 45°	4 pkg. of 5
11127A	Dynapak Grease Fitting, M10 X 1 90°	4 pkg. of 5
11131A	Dynapak Grease Fitting, 3/16"	4 pkg. of 5
11132A	Dynapak Grease Fitting, 1/4"	4 pkg. of 5
11133A	Dynapak Grease Fitting, 5/16"	4 pkg. of 5
11134A	Dynapak Grease Fitting, 3/8"	4 pkg. of 5
11135A	S.A.E. Grease Fittings Dynapak	3 pkg. of 10
11136A	Metric Grease Fittings Dynapak	3 pkg. of 10
11142A	Grease Hose 12"	3 ea.
11143A	Grease Hose 18"	3 ea.

Merchandisers



Assortment End Cap Display

PART#	CONTENTS
100805	Display Only Includes Header Sign & Pegs
10124K	Assortments End Cap Display. 40 part #'s, 240 pieces. Includes header and the products listed below:

PART#	DESCRIPTION	QTY.
00108	Metric Grease Fitting Assortment	6
00112	S.A.E. Grease Fitting Assortment	6
00119	Mini Plug In Fuses 9 Sizes	6
00121	Plug In Fuses 8 Sizes	6
00150	S.A.E. O-Ring Assortment	6
00151	Metric O-Ring Assortment	6
10100	Spring Assortment	6
10101	HNBR O-Ring Assortment	6
10102	Cotter Pin Assortment	6
10103	Large Cotter Pin Assortment	6
10104	E Retainer Ring Assortment	6
10105	Hair Pin Assortment	6
10106	External Retainer Ring Assortment	6
10107	Wire Terminal Assortment	6
10108	Grommet Assortment	6
10109	Grease Fitting Assortment	6
10110	Auto Fuse Assortment	6
10113	Woodruff Key Assortment	6
10114	Copper Washer Assortment	6
10118	Fuse Assortment	6
10120	Alligator Clip Assortment	6
10121	Heat Shrink Tube Assortment	6
10123	Quick Link Assortment	6
10124	Internal Retainer Ring Assortment	6
10125	Keystock Assortment 60 Pieces	6
10126	Body Shim Assortment	6
10129	Electrical Clip Assortment	6
10130	Dual Wall Adhesive Assortment	6
10133	Solderless Terminal Assortment	6
10136	Aluminum D-Ring Assortment	6
10138	Spring Pin Assortment	6
10140	Clevis Pin Assortment	6
10142	U-Clip and Screw Assortment	6
10143	S.S. Cotter Pin Assortment	6
10144	Industrial Shop Assortment	6
10145	Quick Splice Connector Assortment	6



PART#	DESCRIPTION	QTY.
10147	Rubber Insulated Clamp Assortment	6
10148	Linch Pin Assortment	6
10149	Quick Pin Assortment	6
10150	Hose Clamps Assortment	6

Merchandisers



**PlanoGrams do not include gondola or shelves and may not be exactly as illustrated. *Retail hanging pegs not provided



Assortments Merchandiser

PART#	CONTENTS
01026	Assortments - 48"X72" Backdrop Does not include product
01026K	Assortments Merchandiser 48"x72". 48 part #'s, 288 pieces. Includes header, and the products listed below:

PART#	DESCRIPTION	QTY.
80010	Push-pin Rivet, Black Plastic	8
00108	Metric Grease Fitting Assort	6
00112	S.A.E. Grease Fitting Assortm	6
00119	Mini Plug In Fuses 9 Sizes	6
00121	Plug In Fuses 8 Sizes	6
00150	S.A.E. O-Ring Assortment	6
00151	Metric O-Ring Assortment	6
10100	Spring Assortment	6
10101	HNBR O-Ring Assortment	6
10102	Cotter Pin Assortment	6
10103	Large Cotter Pin Assortment	6
10104	E Retainer Ring Assortment	6
10105	Hair Pin Assortment	6
10106	External Retainer Ring Assortment	6
10107	Wire Terminal Assortment	6
10108	Grommet Assortment	6
10109	Grease Fitting Assortment	6
10110	Auto Fuse Assortment	6
10112	Allen Cap Screw Assortment	6
10113	Woodruff Key Assortment	6
10114	Copper Washer Assortment	6
10115	Rubber Sealing Washer Assortment	6
10117	Rivet Hardware Assortment	6
10118	Fuse Assortment	6
10119	Socket Set Screw Assortment	6
10120	Alligator Clip Assortment	6
10121	Heat Shrink Tube Assortment	6
10122	Cotter Pin Assortment	6
10123	Quick Link Assortment	6
10124	Internal Retainer Ring Assortment	6
10125	Keystock Assortment	6
10126	Body Shim Assortment	6
10127	Auto Fuse Assortment	6
10129	Electrical Clip Assortment	6
10130	Dual Wall Adhesive Assortment	6
10133	Solderless Terminal Assortment	6
10136	Aluminum D-Ring Assortment	6
10137	Retainer Ring Assortment	6
10138	Spring Pin Assortment	6



PART#	DESCRIPTION	QTY.
10139	Large Cotter Pin Assortment	6
10140	Clevis Pin Assortment 60 Pieces	6
10142	U-Clip and Screw Assortment	6
10143	S.S. Cotter Pin Assortment	6
10144	Industrial Shop Assortment	6
10145	Quick Splice Connector Assortment	6
10147	Rubber Insulated Clamp Assortment	6
10148	Linch Pin Assortment	6
10149	Quick Pin Assortment 20 Pieces / 3 Sizes	6
10150	Hose Clamps Assortment 34 Pieces / 6 Sizes	6



Dynakit Assortments Merchandiser

PART#	CONTENTS
00296	Dynakits Display Board Only , 12" x 24"
00296K	Full Dynakits Merchandiser . 16 part #'s, 40 pieces. Includes 00296 display board, 16 pegs (80004) and the products listed below:

PART#	DESCRIPTION	QUANTITY
00140	Std. Plug-In Fuses	2 ea.
00141	Mini Plug-In Fuses	3 ea.
00160	Cotter Pins	4 ea.
00161	Cotter Pins (large)	3 ea.
00163	S.A.E. Grease Fittings	4 ea.
00164	Hair Pins Dynakit	4 ea.
00173	Spring Pins	4 ea.
00174	Woodruff Keys	2 ea.
00175	"E" Retainer Rings	1 ea.
00176	Int. Retainer Rings	1 ea.
00177	Ext. Retainer Rings	1 ea.
00178	Clevis Pins	1 ea.
00179	S.A.E. O-Ring Dynakit	2 ea.
00180	Keystock Dynakit	3 ea.
00181	Metric Grease Fittings	3 ea.
00182	Drive-In Grease Fittings	2 ea.



Dynatray Assortments Merchandiser

PART#	CONTENTS
00031	Dynatrays Display Board Only , two - 24" x 24"
00031K	Full Dynatrays Merchandiser . 20 part #'s, 80 pieces. Includes 00031A, 00031B display boards, 20 pegs (80004) and product listed below:

PART#	DESCRIPTION	QUANTITY	PART#	DESCRIPTION	QUANTITY
00108	Metric Grease Fitting Assortment	4 ea.	10115	Rubber Sealing Washers Assortment	4 ea.
00112	S.A.E. Grease Fitting Assortment	4 ea.	10117	Rivet Hardware Assortment	4 ea.
10100	Springs Assortment	4 ea.	10118	Fuses Assortment	4 ea.
10101	HNBR O-Rings Assortment	4 ea.			
10102	Cotter Pin Assortment	4 ea.			
10103	Large Cotter Pin Assortment	4 ea.			
10104	Ext."E" Retainer Ring Assortment	4 ea.			
10105	Hair Pins Assortment	4 ea.			
10106	External Snap Rings Assortment	4 ea.			
10107	Wire Terminal Assortment	4 ea.			
10108	Grommets Assortment	4 ea.			
10109	Grease Fitting Assortment	4 ea.			
10110	Auto Fuse Assortment	4 ea.			
10111	Wire Connectors Assortment	4 ea.			
10112	Allen Cap Screws Assortment	4 ea.			
10113	Woodruff Keys Assortment	4 ea.			
10114	Copper Washers Assortment	4 ea.			

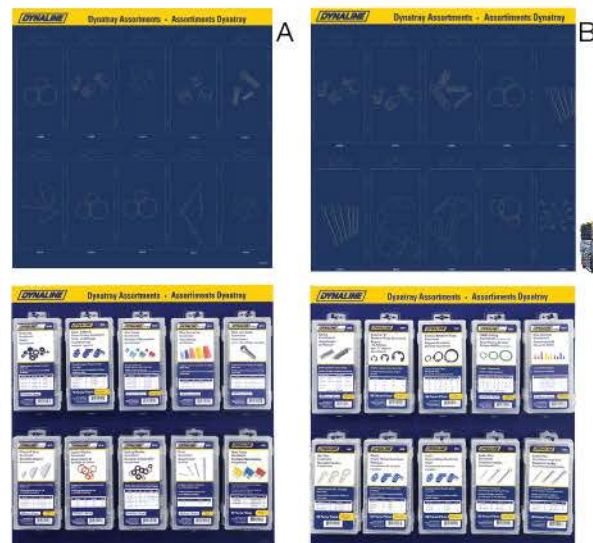

Assortments Plan-O-Gram

PART#	CONTENTS
-------	----------

01021 Assortments **Backdrop Only**, 48" x 48"

01021K **Full Assortments Plan-O-Gram** . 42 part #'s, 88 pieces. Includes 01021, and the products listed below:

PART#	DESCRIPTION	PKG.	PART#	DESCRIPTION	PKG.
00108	Metric Grease Fitting Assortment	2 ea.	00182	Drive-In Grease Fitting Dynakit	2 ea.
00112	S.A.E. Grease Fitting Assortment	2 ea.	00189	Universal Clevis Pin Dynakit	2 ea.
00113	Hair Pin Assortment	2 ea.	10100	Spring Assortment	2 ea.
00119	Mini Plug-In Fuses	2 ea.	10101	HNBR O-Ring Assortment	2 ea.
00121	Plug-In Fuses	2 ea.	10102	Cotter Pin Assortment	2 ea.
00133	Auto Electrical Repair Kit	2 ea.	10103	Large Cotter Pin Assortment	2 ea.
00141	Mini Plug-In Fuses	2 ea.	10104	Ext. E Retainer Ring Assortment	2 ea.
00150	S.A.E. O-Ring Assortment	2 ea.	10105	Hair Pin Assortment	2 ea.
00151	Metric O-Ring Assortment	2 ea.	10106	External Snap Ring Assortment	2 ea.
00152	High pressure O-Ring Assortment	2 ea.	10107	Wire Terminal Assortment	2 ea.
00157	O-Ring Flange Kit	2 ea.	10108	Grommet Assortment	2 ea.
00160	Cotter Pin Dynakit (Small)	2 ea.	10109	Grease Fitting Assortment	2 ea.
00161	Cotter Pin Dynakit (Large)	2 ea.	10110	Auto Fuse Assortment	2 ea.
00163	S.A.E. Grease Fitting Dynakit	4 ea.	10111	Wire Connectors Assortment	2 ea.
00164	Hair Pin Dynakit	4 ea.	10112	Allen Cap Screw Assortment	2 ea.
00173	Spring Pin Dynakit	2 ea.	10113	Woodruff Key Assortment	2 ea.
00175	E Retainer Ring Dynakit	2 ea.	10114	Copper Washer Assortment	2 ea.
00177	External Retainer Ring Dynakit	2 ea.	10115	Rubber Sealing Washer Assortment	2 ea.
00178	Clevis Pin Dynakit	2 ea.	10117	Rivet Hardware Assortment	2 ea.
00180	Keystock Dynakit	2 ea.	10118	Fuse Assortment	2 ea.
00181	Metric Grease Fitting Dynakit	2 ea.	10119	Socket Set Screw Assortment	2 ea.



Merchandisers



*Retail hanging pegs not provided





*Retail hanging pegs not provided



Cargo Control Plan-O-Gram

PART#	CONTENTS
01052	Cargo Control Backdrop Only , 48" x 48"
01052K	Full Cargo Control Plan-o-gram . 20 part#s, 75 pieces. Includes 01052 and the products listed below:

PART#	DESCRIPTION	QUANTITY
11182	Cam Strap, 1" x 6'	2 ea.
11183	Ratchet Strap, 1" x 15'	2 ea.
11183B	Ratchet Strap, 1" x 15' - Bulk	15 ea.
11185	Cam Strap, 1" x 10' - H.D.	2 ea.
11186	Ratchet Strap, 1-1/2" x 25' - H.D.	2 ea.
12230	Ratchet Strap, 1-1/2" x 15'	6 ea.
11189	Ratchet Strap, 1" x 15'	2 ea.
11189B	Ratchet Strap, 1" x 15' - Bulk	12 ea.
11190	Ratchet Strap, 2" x 27' - H.D.	2 ea.
11190B	Ratchet Strap, 2" x 27' - H.D. - Bulk	10 ea.
12207	Ratchet Strap, 1" x 15', Steel Hook	2 ea.
12251	Recessed Anchor, 3-1/2"	2 ea.
12252	Recessed Anchor, 4-7/16" - HD	2 ea.
12320	Ratchet Strap, 1" x 15', Four Pack	2 ea.
12321	Ratchet Strap, 1" x 15', Four Pack	2 ea.
12340	Ratchet Strap, 1" x 15', J-Hooks	2 ea.
12341	Ratchet Strap, 2" x 15', J-Hooks	2 ea.
50920	Ratchet Strap, 2" x 20' - 9,000 lb	2 ea.
50921	Recovery Strap, 3" x 20' - 13,500 lb	2 ea.
50922	Recovery Strap, 4" x 20' - 17,500 lb	2 ea.

Load Binder/Cable Puller Rack

PART#	CONTENTS
70098	Load Binder Rack Only , 24" wide x 31.8" high x 20.6" deep
70098K	Full Cable Pullers & Load Binder Rack . 11 part #s, 22 pieces. Includes 24" x 24" Display Board and the products listed below:

PART#	DESCRIPTION	QTY.
11351	Cable Puller 1 Ton	2 ea.
11352	Cable Puller 2 Ton	2 ea.
11354	Cable Puller 4 Ton	2 ea.
66196	Ratchet Load Binder 1/4 - 5/16	2 ea.
66197	Ratchet Binder 5/16 - 3/8	2 ea.
66198	Ratchet Binder 3/8 - 1/2	2 ea.
66199	Ratchet Binder 1/2 - 5/8	2 ea.
66200	Load Tightener 3/16 - 1/4	2 ea.
66202	Load Binder 3/8 - 1/2	2 ea.
66203	Load Binder 1/4 - 5/16	2 ea.
66204	Load Binder 5/16 - 3/8	2 ea.
70098	Rack Display	1 ea.



Merchandisers



Wire Rope Accessories Merchandisers 12x24

PART#	CONTENTS
00566	Wire Rope Accessories Display Board Only , 12" x 24"
00566K	Full Wire Rope Accessories Merchandiser . 30 part #s, 214 pieces. Includes 00566 display board and 30 pegs (80004) and the products listed below:



Merchandisers



00024 Compatible

PART#	DESCRIPTION	QTY.
77030	Malleable Clip, 1/8"	1 pkg. of 10
77031	Malleable Clip, 3/16"	1 pkg. of 10
77032	Malleable Clip, 1/4"	1 pkg. of 10
77033	Malleable Clip, 5/16"	1 pkg. of 10
77034	Malleable Clip, 3/8"	2 pkg. of 5
77035	Malleable Clip, 1/2"	2 pkg. of 5
77040	Forged Clip, 1/8"	1 pkg. of 5
77041	Forged Clip, 3/16"	1 pkg. of 5
77042	Forged Clip, 1/4"	1 pkg. of 5
77043	Forged Clip, 5/16"	1 pkg. of 5
77044	Forged Clip, 3/8"	1 pkg. of 5
77045	Forged Clip, 1/2"	1 pkg. of 5
77050	Thimble, 1/8"	1 pkg. of 10
77051	Thimble, 3/16"	1 pkg. of 10
77052	Thimble, 1/4"	1 pkg. of 10
77053	Thimble, 5/16"	1 pkg. of 10
77054	Thimble, 3/8"	1 pkg. of 10
77055	Thimble, 1/2"	1 pkg. of 5
77060	Thimble, 1/4" HD	1 pkg. of 10
77061	Thimble, 5/16" HD	1 pkg. of 10
77062	Thimble, 3/8" HD	1 pkg. of 10
77063	Thimble, 1/2" HD	1 pkg. of 5
77064	Thimble, 5/8" HD	10 ea.
77107	Mini Cable Clipper	2 ea.
97080	Cable Sleeve Dynapak	4 pkgs.
97081	Cable Sleeve Dynapak	4 pkgs.
97082	Cable Sleeve Dynapak	4 pkgs.
97083	Cable Sleeve Dynapak	4 pkgs.
97084	Cable Sleeve Dynapak	4 pkgs.
97085	Cable Sleeve Dynapak	2 pkgs.



Stainless Steel Hardware Merchandiser

PART#	CONTENTS
00619	Stainless Steel Hardware Display Board Only , 12" x 24"
00619K	Full Stainless Steel Merchandiser . 35 part #s, 175 pieces. Includes 00619 display board, 40 pegs (80004) and the products listed below:

PART#	DESCRIPTION	QTY.
64000	Quick Link, 1/8"	1 pkg. 5
64001	Quick Link, 5/32"	1 pkg. 5
64002	Quick Link, 1/4"	1 pkg. 5
64003	Quick Link, 5/16"	1 pkg. 5
64004	Quick Link, 3/8"	1 pkg. 5
64020	Wire Rope Clip, 1/8"	1 pkg. 5
64021	Wire Rope Clip, 3/16"	1 pkg. 5
64022	Wire Rope Clip, 1/4"	1 pkg. 5
64023	Wire Rope Clip, 5/16"	1 pkg. 5
64024	Wire Rope Clip, 3/8"	1 pkg. 5
64040	Thimble, 1/8"	1 pkg. 5
64041	Thimble, 3/16"	1 pkg. 5
64042	Thimble, 1/4"	1 pkg. 5
64043	Thimble, 5/16"	1 pkg. 5
64044	Thimble, 3/8"	1 pkg. 5
64060	Shackle, 3/16"	1 pkg. 5
64061	Shackle, 1/4"	1 pkg. 5
64062	Shackle, 5/16"	1 pkg. 5
64063	Shackle, 3/8"	1 pkg. 5
64070	Snap Link, 3/16"	1 pkg. 5
64071	Snap Link, 1/4"	1 pkg. 5
64072	Snap Link, 5/16"	1 pkg. 5
64073	Snap Link, 3/8"	1 pkg. 5
64100	Bolt Snap, 1/2"	1 pkg. 5
64101	Bolt Snap, 3/4"	1 pkg. 5
64102	Security Snap, 5/8"	1 pkg. 5
64103	Security Snap, 3/4"	1 pkg. 5
64104	Security Snap, 7/8"	1 pkg. 5
64105	Spring Snap, 2"	1 pkg. 5
64106	Spring Snap, 2-3/8"	1 pkg. 5
64107	Spring Snap, 3-3/4"	1 pkg. 5
64108	Boat Snap, 10 x 53	1 pkg. 5
64109	Boat Snap, 16 x 72	1 pkg. 5
64110	Boat Snap, 19 x 81	1 pkg. 5
64111	Boat Snap, 19 x 98	1 pkg. 5



Merchandisers





Merchandisers



Chain Connectors Merchandiser

PART#	CONTENTS
00614	Chain Connectors Display Board Only , 12" x 24"
00614K	Full Chain Connectors Merchandiser . 35 part #s, 218 pieces. Includes 00614 display board, 35 pegs (80004) and the products listed below:

PART#	DESCRIPTION	QUANTITY
66138	Mid Link, 1/4"	4 ea.
66139	Mid Link, 3/8"	4 ea.
66140	Mid Link, 1/2"	2 ea.
66165	Chain Swivel, 1/4"	1 pkg. of 2
66166	Chain Swivel, 5/16"	1 pkg. of 2
66167	Chain Swivel, 3/8"	1 pkg. of 2
66168	Chain Swivel, 1/2"	1 pkg. of 2
66400	Repair Link, 1/8"	1 pkg. of 10
66401	Repair Link, 3/16"	1 pkg. of 10
66402	Repair Link, 1/4"	1 pkg. of 10
66403	Repair Link, 5/16"	1 pkg. of 5
66404	Repair Link, 3/8"	1 pkg. of 5
66413	Link Lock, 1/4"	1 pkg. of 5
66414	Link Lock 5/16"	1 pkg. of 5
66415	Link Lock, 3/8"	1 pkg. of 5
66416	Missing Link, 1/4"	1 pkg. of 5
66417	Missing Link, 5/16"	1 pkg. of 5
66418	Missing Link, 3/8"	1 pkg. of 5
66419	Snap Link, 5 mm	1 pkg. of 10
66420	Snap Link, 6 mm	1 pkg. of 10
66421	Snap Link, 8 mm	1 pkg. of 10
66422	Snap Link, 10 mm	1 pkg. of 10
66425	Snap Link, 11 mm	1 pkg. of 5
66426	Snap Link, 12 mm	1 pkg. of 5
66430	Quick Link, 1/8"	1 pkg. of 10
66431	Quick Link, 3/16"	1 pkg. of 10
66432	Quick Link, 1/4"	1 pkg. of 10
66433	Quick Link, 5/16"	1 pkg. of 5
66434	Quick Link, 3/8"	1 pkg. of 5
66435	Quick Link, 7/16"	1 pkg. of 5
66436	Quick Link, 1/2"	1 pkg. of 5
66440	Cold Shut, 3/16"	1 pkg. of 10
66441	Cold Shut, 1/4"	1 pkg. of 10
66442	Cold Shut, 5/16"	1 pkg. of 5
66443	Cold Shut, 3/8"	1 pkg. of 5



Chain Hooks Merchandiser

PART#	CONTENTS
00408	Chain Hooks Display Board Only , 24" x 24"
00408K	Full Chain Hooks Merchandiser . 30 part #s, 120 pieces. Includes 00408 display board, 30 pegs (80004) and the products listed below:

PART#	DESCRIPTION	QTY.	PART#	DESCRIPTION	QTY.
66070	Clevis Slip Hook, c/w latch, 1/4"	4 ea.	66117	Clevis Slip Hook, 3/8"	4 ea.
66071	Clevis Slip Hook, c/w latch, 5/16"	4 ea.	66120	Clevis Grab Hook, Alloy, 1/4"	4 ea.
66072	Clevis Slip Hook, c/w latch, 3/8"	4 ea.	66121	Clevis Grab Hook, Alloy, 5/16"	4 ea.
66073	Clevis Slip Hook, c/w latch, 1/4"	4 ea.	66122	Clevis Grab Hook, Alloy, 3/8"	4 ea.
66074	Clevis Slip Hook, c/w latch, 5/16"	4 ea.	66123	Eye Grab Hook, 1/4"	4 ea.
66075	Clevis Slip Hook, c/w latch, 3/8"	4 ea.	66124	Eye Grab Hook, 5/16"	4 ea.
66080	Alloy Grab Hook, c/w latch, 1/4"	4 ea.	66125	Eye Grab Hook, 3/8"	4 ea.
66081	Alloy Grab Hook, c/w latch, 5/16"	4 ea.	66129	Eye Slip Hook, 1/4"	4 ea.
66082	Alloy Grab Hook, c/w latch, 3/8"	4 ea.	66130	Eye Slip Hook, 5/16"	4 ea.
66110	Clevis Grab Hook, 1/4"	4 ea.	66131	Eye Slip Hook, 3/8"	4 ea.
66111	Clevis Grab Hook, 5/16"	4 ea.	66136	Safety Winch Hook, 1/4"	4 ea.
66112	Clevis Grab Hook, 3/8"	4 ea.	66137	Safety Lanyard Hook (single)	4 ea.
66115	Clevis Slip Hook, 1/4"	4 ea.	66137S	Safety Lanyard Hook (double)	4 ea.
66116	Clevis Slip Hook, 5/16"	4 ea.	66145	Eye Hoist Hook, 3/4T	4 ea.
			66146	Eye Hoist Hook, 1T	4 ea.
			66147	Eye Hoist Hook, 1.5T	4 ea.



Shackles & Clevises Merchandiser

PART#	CONTENTS
00386	Shackles & Clevises Display Board Only (24" x 24")
00386K	Full Shackles & Clevises Merchandiser . 25 part #s, 78 pieces. Includes 00386 display board, 25 pegs (80004) and products listed below:

PART#	DESCRIPTION	QTY.	PART#	DESCRIPTION	QTY.
66000	Anchor Shackle, 1/4"	4 ea.	66013	Anchor Shackle, 1/2"	4 ea.
66001	Anchor Shackle, 5/16"	4 ea.	66014	Anchor Shackle, 5/8"	2 ea.
66002	Anchor Shackle, 3/8"	4 ea.	66017	Anchor Shackle, 7/16"	2 ea.
66003	Anchor Shackle, 7/16"	4 ea.	66020	Chain Shackle, 1/4"	4 ea.
66004	Anchor Shackle, 1/2"	4 ea.	66021	Chain Shackle, 5/16"	4 ea.
66005	Anchor Shackle, 5/8"	2 ea.	66022	Chain Shackle, 3/8"	4 ea.
66006	Anchor Shackle, 3/4"	2 ea.	66023	Chain Shackle, 7/16"	4 ea.
66007	Anchor Shackle, 7/8"	2 ea.	66024	Chain Shackle, 1/2"	4 ea.
66008	Anchor Shackle, 1"	2 ea.	66029	Straight Clevis, 5/8"	2 ea.
66010	Anchor Shackle, 1/4"	4 ea.	66030	Straight Clevis, 3/4"	2 ea.
66011	Anchor Shackle, 5/16"	4 ea.	66031	Straight Clevis, 7/8"	2 ea.
66012	Anchor Shackle, 3/8"	4 ea.	66032	Straight Clevis, 15/16"	2 ea.
			66033	Straight Clevis, 1"	2 ea.

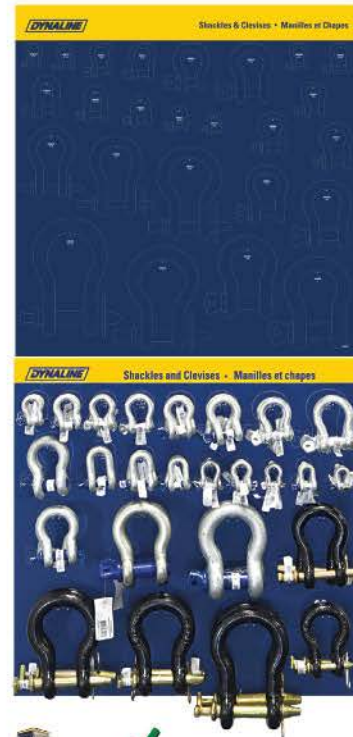

Merchandisers



Wire Rope Accessories Merchandiser

PART#	CONTENTS
00567	Wire Rope Display Board Only, 24" x 24"
00567K	Full Wire Rope Accessories Merchandiser . 39 part #s, 205 pieces. Includes 00567 display board and 41 pegs (80004) and the products listed below:

PART#	DESCRIPTION	QTY.
77031	Malleable Clip, 3/16"	1 pkg. of 10
77032	Malleable Clip, 1/4"	1 pkg. of 10
77033	Malleable Clip, 5/16"	1 pkg. of 10
77034	Malleable Clip, 3/8"	1 pkg. of 5
77035	Malleable Clip, 1/2"	1 pkg. of 5
77036	Malleable Clip, 5/8"	2 ea.
77037	Malleable Clip, 3/4"	2 ea.
77038	Malleable Clip, 7/8"	2 ea.
77039	Malleable Clip, 1"	2 ea.
77041	Forged Clip, 3/16"	1 pkg. of 5
77042	Forged Clip, 1/4"	1 pkg. of 5
77043	Forged Clip, 5/16"	1 pkg. of 5
77044	Forged Clip, 3/8"	1 pkg. of 5
77045	Forged Clip, 1/2"	1 pkg. of 5
77046	Forged Clip, 5/8"	2 ea.
77047	Forged Clip, 3/4"	2 ea.
77048	Forged Clip, 7/8"	2 ea.
77049	Forged Clip, 1"	2 ea.
77050	Thimble, 1/8"	1 pkg. of 10
77051	Thimble, 3/16"	1 pkg. of 10
77052	Thimble, 1/4"	1 pkg. of 10
77053	Thimble, 5/16"	1 pkg. of 10
77054	Thimble, 3/8"	1 pkg. of 10
77055	Thimble, 1/2"	1 pkg. of 5
77056	Thimble, 5/8"	2 ea.
77060	Thimble, 1/4", H.D.	1 pkg. of 10
77061	Thimble, 5/16", H.D.	1 pkg. of 10
77062	Thimble, 3/8", H.D.	1 pkg. of 10
77063	Thimble, 1/2", H.D.	1 pkg. of 5
77064	Thimble, 5/8", H.D.	2 ea.
77066	Thimble, 7/8", H.D.	2 ea.
77067	Thimble, 1", H.D.	2 ea.
77068	Thimble, 1-1/8", H.D.	2 ea.
97080	Cable Sleeves Dynapak	4 pkg.
97081	Cable Sleeves Dynapak	4 pkg.
97082	Cable Sleeves Dynapak	4 pkg.
97083	Cable Sleeves Dynapak	4 pkg.
97084	Cable Sleeves Dynapak	4 pkg.
97085	Cable Sleeves Dynapak	4 pkg.



Merchandisers



Does not include cable clipper



Chain Rack - 4'

PART#	CONTENTS
70099	Chain Rack Only, 47" wide x 73" high x 13" deep
70099K	Full 4' Chain Rack Merchandiser. 19 part #s, 2620 pieces. Includes 12" x 48" Chain Rack Header and the products listed below:

PART#	DESCRIPTION	QTY.
70003	Grade 30 Chain 3/16" X 250'/Bucket	1 Bucket of 250'
70004	Grade 30 Chain 1/4" X 141'/Bucket	1 Bucket of 141'
70005	Grade 30 Chain 5/16" X 92'/Bucket	1 Bucket of 92'
70006	Grade 30 Chain 3/8" X 63'/Bucket	1 Bucket of 63'
70024	Grade 70 Chain 1/4" X 130'/Bucket	1 Bucket of 130'
70025	Grade 70 Chain 5/16" X 90'/Bucket	1 Bucket of 90'
70026	Grade 70 Chain 3/8" X 64' per Bucket	2 Buckets of 64'
70040	Straight Link Coil Chain, #4 X 100'/Reel	1 Roll of 100'
70045	Passing Link Chain, #2/0 X 120'/Reel	1 Roll of 120'
70050	Twist Link Machine Chain, #2/0 X 75'/Reel	1 Roll of 75'
70051	Twist Link Machine Chain, #4 X 100'/Reel	1 Roll of 100'
70060	Double Loop Lion Chain, #2/0 X 150'/Reel	1 Roll of 150'
70062	Double Loop Lion Chain, #2/0 X 125'/Reel, Blue PVC	1 Roll of 125'
70063	Double Loop Lion Chain, #3 X 200' per Reel	1 Roll of 200'

PART#	DESCRIPTION	QTY.
70075	Sash Chain #35 X 100' per Reel	1 Roll of 100'
70080	Furnace Chain, #91 X 250'/Reel	1 Roll of 250'
70085	Single Jack Chain, #10T X 150'/Reel	1 Roll of 150'
70086	Single Jack Chain, #12 X 100'/Reel	1 Roll of 100'
70087	Single Jack Chain, #14 X 200'/Reel	1 Roll of 200'

Chain Rack - 2'



Chain Rack - 4'

Chain Rack - 2'

PART#	CONTENTS
70010	Chain Rack Only, 23" wide x 73" high x 13" deep
70010K	Full 2' Chain Rack Merchandiser. 16 part #s, 1972 pieces. Includes 9" x 23" Dynaline Distributor sign (00003) and the products listed below:

PART#	DESCRIPTION	QTY.
70010	Chain Rack - 2 ft.	1 ea.
70005	Chain 5/16"x 92' Grade 30	1 bucket of 92'
70007	Chain 3/16" x 100' Grade 30	1 bucket of 100'
70008	Chain 1/4" x 65' Grade 30	1 bucket of 65'
70016	Chain 3/8"x 45' Grade 30	1 bucket of 45'
70040	Straight Link Coil Chain, #4 x 100'	1 reel of 100'
70045	Passing Link Chain, #2/0 x 120'	1 reel of 120'
70050	Twist Link Mach. Chain, #2/0 x 75'	1 reel of 75'
70051	Twist Link Mach. Chain, #4 x 100'	1 reel of 100'

PART#	DESCRIPTION	QTY.
70060	Double Loop Lion Chain, #2/0 x 150'	1 reel of 150'
70062	Double Loop Lion Chain, #2 x 125'	1 reel of 125'
70063	Double Loop Lion Chain, #3 x 200'	1 reel of 200'
70075	Sash Chain, #35 x 100'	1 reel of 100'
70080	Furnace Chain, #91 x 250'	1 reel of 250'
70085	Single Jack Chain, #10T x 150'	1 reel of 150'
70086	Single Jack Chain, #12 x 100'	1 reel of 100'
70087	Single Jack Chain, #14 x 200'	1 reel of 200'



Merchandisers





Merchandisers



7x7

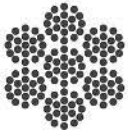

7x19



Chain & Steel Cable Rack Merchandiser

PART#	CONTENTS
70010	Steel Cable Rack Only (23" x 13" x 73") Free standing floor rack for Wire Rope Spools
00465K	Full Steel Cable Rack Merchandiser. 13 part #s, 2772 pieces. Includes 70010 Steel Cable Display Rack (Dimensions: 23" x 13" x 73") with 9" x 23" header and the products listed below:

PART#	DESCRIPTION	QTY.
77010	Chain Rack - 2 ft.	1 ea.
77000	Aircraft Cable, 1/16", 500 ft. reel	1 reel of 500'
77001	Aircraft Cable, 3/32", 500 ft. reel	1 reel of 500'
77002	Aircraft Cable, 1/8", 250 ft. reel	1 reel of 250'
77003	Aircraft Cable, 5/32", 250 ft. reel	1 reel of 250'
77004	Aircraft Cable, 3/16", 250 ft. reel	1 reel of 250'
77005	Aircraft Cable, 1/4", 250 ft. reel	1 reel of 250'
77007	Aircraft Cable, 3/8", 250 ft. reel	1 reel of 250'
70040	Straight Link Coil Chain, #4, 100' reel	1 reel of 100'
70045	Passing Link Chain, #2/0, 120' reel	1 reel of 120'
70007	Grade 30 Chain, 3/16", 100' bucket	1 bucket of 100'
70005	Grade 30 Chain, 5/16", 92' bucket	1 bucket of 92'
70008	Grade 30 Chain, 1/4", 65' bucket	1 bucket of 65'
70016	Grade 30 Chain, 3/8", 45' bucket	1 bucket of 45'

DYNALINE

For more information on these products see the Chain and Rigging section of the catalogue!



Your Trusted Source.



General Hardware Merchandiser

PART#	CONTENTS
01081	General Hardware Backdrop Only , 48" x 48"
01081K	Full General Hardware Plan-o-gram . 137 part #s, 967 pieces. Includes 01081 and the products listed below:

PART#	DESCRIPTION	QTY.
64100	S.S. Bolt Snap 1/2 x 3	5
64101	S.S. Bolt Snap 3/4 x 3-1/2	5
64102	S.S. Security Snap 5/8	5
64103	S.S. Security Snap 3/4	5
64104	S.S. Security Snap 7/8	5
64105	S.S. Spring Snap 1-7/8	5
64106	S.S. Spring Snap 2-5/8	5
64107	S.S. Spring Snap 3--7/8	5
64108	S.S. Boat Snap 2	5
64109	S.S. Boat Snap 2-3/4	5
64110	S.S. Boat Snap 3-1/4	5
64111	S.S Boat Snap 3-7/8	5
65102	Eyebolt 3/16 x 2	10
65104	Eyebolt 3/16 x 2-1/2	10
65106	Eyebolt 1/4 x 2	10
65107	Eyebolt 1/4 x 2-1/2	10
65108	Eyebolt 1/4 x 3	10
65109	Eyebolt 1/4 x 4	10
65110	Eyebolt 1/4 x 5	10
65111	Eyebolt 1/4 x 6	10
65112	Eyebolt 5/16 x 3-1/4	10
65113	Eyebolt 5/16 x 4	10
65114	Eyebolt 5/16 x 5	10
65115	Eyebolt 5/16 x 6	10
65117	Eyebolt 3/8 x 4	10
65118	Eyebolt 3/8 x 5	10
65119	Eyebolt 3/8 x 6	10
65120	Eyebolt 3/8 x 8	10
65123	Eyebolt 1/2 x 6	10
65124	Eyebolt 1/2 x 8	10
65140	U-Bolts 1/4 x 1-1/8 3/4 Pipe	10
65141	U-Bolt 1/4 x 1-3/8 1" Pipe	10
65142	U-Bolt 1/4 x 2 1-1/2 Pipe	10
65143	U-Bolt 5/16 x 1-3/8 1" Pipe	10
65144	U-Bolt 5/16 x 1-3/8 1" Pipe	10
65145	U-Bolt 5/16 x 1-3/4 1-1/4 Pipe	10
65146	U-Bolt 5/16 x 1-3/4 1-1/4 Pipe	10
65147	U-Bolt 5/16 x 2 1-1/2 Pipe	10
65148	U-Bolt 5/16 x 2 1-1/2 Pipe - 10 pcs / pkg	10

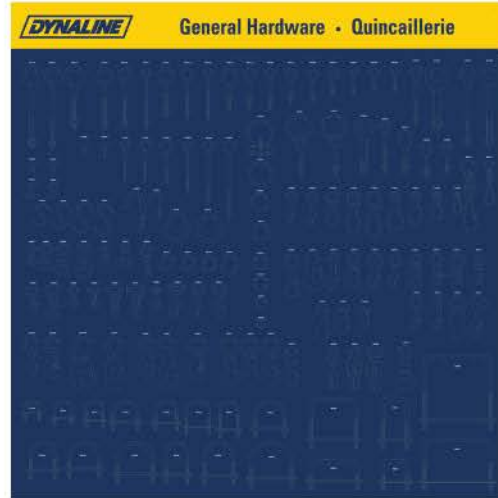

Plan-O-Grams do not include gondola or shelves. Products may not be exactly as illustrated.

PART#	DESCRIPTION	QTY.
65149	U-Bolt 5/16 x 2-1/2 2" Pipe	10
65150	U-Bolt 5/16 x 2-1/2 2" Pipe	10
65151	U-Bolt 3/8 x 2-1/2 2" Pipe	10
65152	U-Bolt 3/8 x 3 2-1/2 Pipe	10
65153	U-Bolt 3/8 x 3-1/2 3" Pipe	10
65161	Lagscrew Eyebolt 1/4 3-3/4 Pipe	10
65162	Lagscrew Eyebolt 1/4 5" Pipe -	10
65163	Lagscrew Eyebolt 5/16 4" Pipe	10
65164	Lagscrew Eyebolt 5/16 6" Pipe	10
65165	Lagscrew Eyebolt 3/8 4-1/2" Pipe	10
65166	Lagscrew Eyebolt 3/8 8" Pipe	10
65172	Ring & Eyebolt	10
65177	Ring & Lagscrew Eyebolt	10
65178	Ring & Mounting Plate	10
65181	Square U-Bolt 3/8 - 2 x 3	5
65182	Square U-Bolt 3/8 - 2 x 5	5



Merchandisers



General Hardware Continued

PART#	DESCRIPTION	QTY.	PART#	DESCRIPTION	QTY.
65184	Square U-Bolt 3/8 - 4 x 3	5	66342	Double Bolt Snap 7/16 x 3-1/2	5
65185	Square U-Bolt 3/8 - 4 x 5	5	66343	Bolt Snap 3/4 3/4 x 3-1/2	5
65187	Square U-Bolt 3/8 - 6 x 5	5	66344	Trigger Snap 3/4 3/4 x 2-3/4	5
65188	Square U-Bolt 3/8 - 6 x 7	5	66346	Loop Snap 3/4 3/4 x 3-1/8	5
66100	Eyebolt 1/4 x 2	2	66347	Loop Snap 1 1 x 2-15/16	5
66101	Eyebolt 5/16 x 2-1/4	2	66348	Square Trigger Snap 3/4 x 2-1/2	5
66102	Eyebolt 3/8 x 2-1/2	2	66349	Trigger Snap 1 1 x 3-1/2	5
66103	Eyebolt 1/2 x 3-1/4	2	66350	Trigger Snap 3/4 3/4 x 3-7/8	5
66104	Eyebolt 5/8 X 4	2	66351	Spring Snap 1 x 3-1/8	5
66105	Eyebolt 1/4 x 4	2	66352	Swivel Loop Snap 3/4 3/4 x 3-1/4	5
66106	Eyebolt 5/16 x 4 1/4	2	66353	Swivel Loop Snap 1 1 x 3-1/4	5
66107	Eyebolt 3/8 x 6	2	66354	Mini Bolt Snap 7/16 x 2-1/8	5
66108	Eyebolt 1/2 x 6	2	66355	Open Decoy Snap 1/2 x 2-1/2	5
66137	Safety Lanyard Hook Single Latch	2	66356	Flat Spring Snap - 11/16 x 4-3/8	5
66137S	Safety Lanyard Hook Double Latch	2	66360	Solid Brass Bolt Snap 1/2" x 3	5
66173	D-Ring 1 x 7/8	10	66361	Brass Bolt Snap 1" x 3-1/2"	5
66174	D-Ring 1-1/8 x 7/8	10	66365	Baby Square Eye Snap 5/8"	5
66175	D-Ring 1-5/16 x 1	10	66366	Bolt Snap 9/16" x 3-1/4"	5
66176	D-Ring 1-5/8 x 1-1/8	10	66367	Zinc Swivel Snap 1/2 x 2	5
66178	D-Ring 2 x 1-3/4 Heavy Duty	10	66368	Zinc Swivel Snap 5/8 x 2-7/16	5
66179	D-Ring 2 x 1-7/8 Heavy Duty	10	66369	Zinc Swivel Snap 3/4 x 2-5/8	5
66180	Key Ring - 5/8 I.D., 3/4 O.D.	10	66370	1" Zinc Swivel Snap 1 x 3	5
66182	Key Ring - 27/32 I.D., 1" O.D.	10	66371	Swivel Eye Snap 1/2" 3/8 x 1-3/4	5
66184	Key Ring - 1-5/64 ID, 1-1/4 OD	10	66372	Swivel Eye Snap 3/8" 3/8 x 2-3/8	5
66230	S-Hook 1" .093" x 1"	10	66374	Lever Snap 5/8 x 3-1/4	5
66232	S-Hook 1-3/32 .105 x 1-3/32	10	66375	Lever Snap 3/4 x 3-1/2	5
66234	S-Hook 1-3/8 .120 x 1-3/8	10	66376	Lever Snap 1 x 3-1/2	5
66235	S-Hook 1-1/2 .162 x 1-1/2	10	66377	Lever Snap 1-1/8 x 4-7/16	5
66236	S-Hook 2-1/8 .141 x 2-1/8	10	66380	Security Snap 7/8" 7/8 x 3-7/8	5
66238	S-Hook 2-5/8 .250 x 2-5/8	10	66381	Security Snap 1" 1 x 5-1/16	5
66239	S-Hook 3" .188 x 3"	10	66385	Eye Bull Snap 3/4"x 3-3/4	5
66241	Tarp Strap Hook	10	66387	Flat Spring Snap 1/2" x 2-3/4"	5
66330	Bull Snap 1 x 4-1/8	5	66390	Harness Ring 1-1/4"	5
66331	Solid Snap Hook 11/16 x 3-1/2	5	66392	Animal Snap Bronze Cast 1" 4-1/2"	5
66332	Cap Snap 1 x 3-5/8	5	66394	Security Snap 1" 4-1/8"	5
66334	Swivel Eye Snap 3/4 3/4 x 3-1/4	5	66410	Steel Ring 1/4 x 1	10
66335	Swivel Eye Snap 7/8 7/8 x 3-1/2	5	66411	Steel Ring 5/16 X1-1/8	10
66336	Dog Lead Snap 3/8 x 2-1/2	5	66412	Steel Ring 7/32 x 1-9/16	10
66338	Panic Snap 1/2 x 4-1/16	5	66423	Tarp Hook 3/8 x 3-1/2	10
66339	Trigger Snap 5/8 5/8 x 2-1/2	5	66424	Tarp Hook 1/4 x 2-1/2	10
66340	Bolt Snap 11/16 x 3-3/8	5	80010	Push-pin Rivet, Black Plastic	5
66341	Open Eye Snap 13/16 X 3-9/16	5			



Merchandisers



Snaps Merchandiser

PART#	CONTENTS
00448	Snaps Display Board Only , 24" x 24"
00448K	Full Snaps Merchandiser . 45 part #s, 240 pieces. Includes 00448 display board, 52 pegs (80004) and products listed below:

PART#	DESCRIPTION	QUANTITY
66330	Bull Snap, 1"	1 pkg. of 5
66331	Solid Snap Hook, 11/16"	1 pkg. of 5
66332	Cap Snap, 1"	1 pkg. of 5
66334	Swivel Eye Snap, 11/16"	1 pkg. of 5
66335	Swivel Eye Snap, 13/16"	1 pkg. of 5
66336	Dog Lead Snap, 3/8"	1 pkg. of 5
66338	Panic Snap, 1/2"	1 pkg. of 5
66339	Trigger Snap, 5/8"	1 pkg. of 5
66340	Bolt Snap, 11/16"	1 pkg. of 5
66341	Open Eye Snap, 13/16"	1 pkg. of 5
66342	Double Bolt Snap, 7/16"	1 pkg. of 5
66343	Bolt Snap, 3/4"	1 pkg. of 5
66344	Trigger Snap, 3/4"	1 pkg. of 5
66346	Loop Snap, 3/4"	1 pkg. of 5
66347	Loop Snap, 1"	1 pkg. of 5
66348	Square Trigger Snap, 3/4"	1 pkg. of 5
66349	Trigger Snap, 1"	1 pkg. of 5
66350	Trigger Snap, 13/16"	1 pkg. of 5
66351	Spring Snap, 1"	1 pkg. of 5
66352	Swivel Loop Snap, 3/4"	1 pkg. of 5
66353	Swivel Loop Snap, 1"	1 pkg. of 5
66354	Mini Bolt Snap, 7/16"	1 pkg. of 5
66355	Open Decoy Snap, 1/2"	1 pkg. of 5
66356	Simplex Snap, 11/16"	1 pkg. of 5
66360	Solid Brass Bolt Snap, 1/2" x 3"	1 pkg. of 5
66361	Brass Bolt Snap, 1"	1 pkg. of 5
66365	Baby Square Eye Snap, 5/8"	1 pkg. of 5
66366	Bolt Snap, 3-1/4"	1 pkg. of 5
66367	1/2" Zinc Swivel Snap	1 pkg. of 5
66368	5/8" Zinc Swivel Snap	1 pkg. of 5
66369	3/4" Zinc Swivel Snap	1 pkg. of 5
66370	1" Zinc Swivel Snap	1 pkg. of 5
66374	5/8" Lever Snap, Nickel Plated	1 pkg. of 5
66375	3/4" Lever Snap, Nickel Plated	1 pkg. of 5
66376	1" Lever Snap, Nickel Plated	1 pkg. of 5
66377	Lever Snap, 1-1/8"	1 pkg. of 5
66380	Security Snap, 7/8"	1 pkg. of 5
66381	Security Snap Hook, 7/8"	1 pkg. of 5
66385	Eye Bull Snap, 3/4"x 3-3/4"	1 pkg. of 5



PART#	DESCRIPTION	QUANTITY
66387	Simplex Spring Snap, Swivel	1 pkg. of 5
66392	Bronze Animal Snap 1"x4-1/2"	1 pkg. of 5
66394	Security Snap Swivel 1"x4-1/8"	1 pkg. of 5
66427	Aluminum Snap Hook, 3/16"	1 pkg. of 10
66428	Aluminum Snap Hook, 1/4"	1 pkg. of 10
66429	Aluminum Snap Hook, 5/16"	1 pkg. of 10



Merchandisers





PART#	DESCRIPTION	QTY.
66176	D-Ring 1-5/8 x 1-1/8	10
66178	D-Ring 2 x 1-3/4 Heavy Duty	10
66180	Key Ring - 5/8 I.D., 3/4 O.D.	10
66182	Key Ring - 27/32 I.D., 1" O.D.	10
66184	Key Ring - 1-5/64 ID, 1-1/4 OD	10
66410	Steel Ring 1/4 x 1	10
66411	Steel Ring 5/16 X1-1/8	10
66412	Steel Ring 7/32 x 1-9/16	10
80004	Metal Peg Hook w/locknut 155mm Long x 5mm Diameter	47

Eyebolts & Rings Merchandiser

PART#	CONTENTS
00611	Eyebolts & Rings Display Board Only , 24" x 24"
00611K	Full Eyebolts & Rings Merchandiser . 47 part #s, 398 pieces. Includes 00611 display board, 47 pegs (80004) and the products listed below:

PART#	DESCRIPTION	QTY.
65102	Eyebolt 3/16 x 2	10
65104	Eyebolt 3/16 x 2-1/2	10
65106	Eyebolt 1/4 x 2	10
65107	Eyebolt 1/4 x 2-1/2	10
65108	Eyebolt 1/4 x 3	10
65109	Eyebolt 1/4 x 4	10
65110	Eyebolt 1/4 x 5	10
65111	Eyebolt 1/4 x 6	10
65112	Eyebolt 5/16 x 3-1/4	10
65113	Eyebolt 5/16 x 4	10
65114	Eyebolt 5/16 x 5	10
65115	Eyebolt 5/16 x 6	10
65117	Eyebolt 3/8 x 4	10
65118	Eyebolt 3/8 x 5	10
65119	Eyebolt 3/8 x 6 1	10
65120	Eyebolt 3/8 x 8	10
65123	Eyebolt 1/2 x 6	10
65124	Eyebolt 1/2 x 8	10
65161	Lagscrew Eyebolt 1/4 3-3/4	10
65162	Lagscrew Eyebolt 1/4 5"	10
65163	Lagscrew Eyebolt 5/16 4"	10
65164	Lagscrew Eyebolt 5/16 6"	10
65165	Lagscrew Eyebolt 3/8 4-1/2"	10
65166	Lagscrew Eyebolt 3/8 8"	10
65172	Ring & Eyebolt	10
65177	Ring & Lagscrew Eyebolt	10
65178	Ring & Mounting Plate	10
66100	Eyebolt 1/4 x 2	2
66101	Eyebolt 5/16 x 2-1/4	2
66102	Eyebolt 3/8 x 2-1/2	2
66103	Eyebolt 1/2 x 3-1/4	2
66104	Eyebolt 5/8 X 4	2
66105	Eyebolt 1/4 x 4	2
66106	Eyebolt 5/16 x 4 1/4	2
66107	Eyebolt 3/8 x 6	2
66108	Eyebolt 1/2 x 6	2
66173	D-Ring 1 x 7/8	10
66174	D-Ring 1-1/8 x 7/8	10
66175	D-Ring 1-5/16 x 1	10



U-Bolts Merchandiser

PART#	CONTENTS				
00612	U-Bolts Display Board Only , 24" x 24"				
00612K	Full U-Bolts Merchandiser . 20 part #s, 170 pieces. Includes 00612 display board, 26 pegs (80004) and the products listed below:				
PART#	DESCRIPTION	QTY.	PART#	DESCRIPTION	QTY.
65140	1/4" x 1-1/8"	1 pkg. of 10	65150	5/16" x 2-1/2"	1 pkg. of 10
65141	1/4" x 1-3/8"	1 pkg. of 10	65151	3/8" x 2-1/2"	1 pkg. of 10
65142	1/4" x 2"	1 pkg. of 10	65152	3/8" x 3"	1 pkg. of 10
65143	5/16" x 1-3/8"	1 pkg. of 10	65153	3-1/2" x 4-5/8"	1 pkg. of 10
65144	5/16" x 1-3/8"	1 pkg. of 10	65181	Square, 2" x 3"	1 pkg. of 5
65145	5/16" x 1-3/4"	1 pkg. of 10	65182	Square, 2" x 5"	1 pkg. of 5
65146	5/16" x 1-3/4"	1 pkg. of 10	65184	Square, 4" x 3"	1 pkg. of 5
65147	5/16" x 2"	1 pkg. of 10	65185	Square, 4" x 5"	1 pkg. of 5
65148	5/16" x 2"	1 pkg. of 10	65187	Square, 6" x 5"	1 pkg. of 5
65149	5/16" x 2-1/2"	1 pkg. of 10	65188	Square, 6" x 7"	1 pkg. of 5

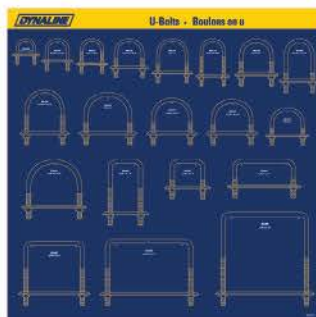

Muffler Clamps Merchandiser

PART#	CONTENTS							
00307	Muffler Clamps Display Board Only , 24" x 24"							
00307K	Full Muffler Clamps Merchandiser . 16 part #s, 32 pieces. Includes 00307 display board, 16 pegs (80004) and the products listed below:							
PART#	DESCRIPTION	QTY.	PART#	DESCRIPTION	QTY.	PART#	DESCRIPTION	QTY.
11225	Muffler Clamp 1-1/2"	2	11231	Muffler Clamp 2-1/4"	2	11237	Muffler Clamp 4-1/2"	2
11226	Muffler Clamp 1-5/8"	2	11232	Muffler Clamp 2-1/2"	2	11238	Muffler Clamp 5"	2
11227	Muffler Clamp 1-3/4"	2	11233	Muffler Clamp 2-3/4"	2	11239	Muffler Clamp 5-1/2"	2
11228	Muffler Clamp 1-7/8"	2	11234	Muffler Clamp 3"	2	11240	Muffler Clamp 6"	2
11229	Muffler Clamp 2"	2	11235	Muffler Clamp 3-1/2"	2			
11230	Muffler Clamp 2-1/8"	2	11236	Muffler Clamp 4"	2			

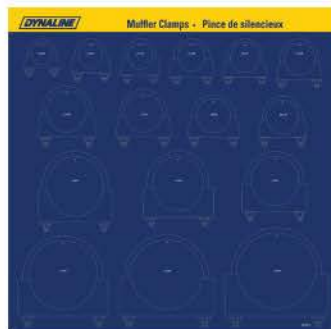

Merchandisers



Pulley Blocks Merchandiser

PART#	CONTENTS
00334	Pulley Blocks Display Board Only , 24" x 24"
00334K	Full Pulley Blocks Merchandiser . 34 part #s, 68 pieces. Includes 00334 display board, 34 pegs (80004) and the products listed below:



Merchandisers

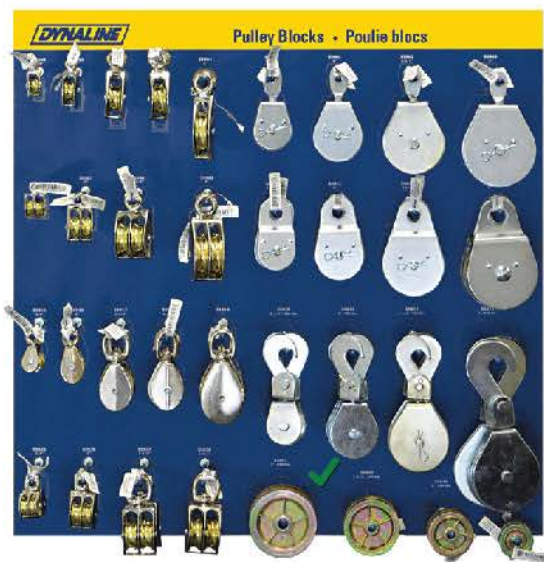
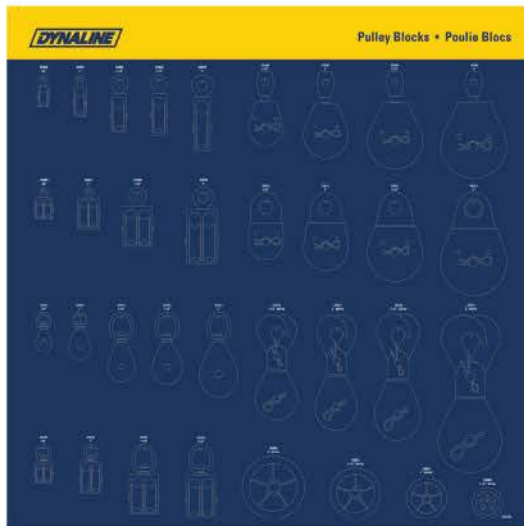

00024
Compatible

PART#	DESCRIPTION	QTY.
55800	Pulley, Swivel Steel, 1-1/2"	2 ea.
55801	Pulley, Swivel Steel, 2"	2 ea.
55802	Pulley, Swivel Steel, 2-1/2"	2 ea.
55803	Pulley, Swivel Steel, 3"	2 ea.
55810	Pulley, Fixed Steel, 1-1/2"	2 ea.
55811	Pulley, Fixed Steel, 2"	2 ea.
55812	Pulley, Fixed Steel, 2-1/2"	2 ea.
55813	Pulley, Fixed Steel, 3"	2 ea.
55840	Sheave 1-1/2", 420 lb	2 ea.
55841	Sheave 2", 480 lb	2 ea.
55842	Sheave 2-1/2", 550 lb	2 ea.
55843	Sheave 3", 650 lb	2 ea.
55870	Double Hook Swivel, 1-1/2"	2 ea.
55871	Double Hook Swivel, 2"	2 ea.
55872	Double Hook Swivel, 2-1/2"	2 ea.
55873	Double Hook Swivel, 3"	2 ea.
55900	Pulley, Sngl. Fixed, 3/4"	2 ea.
55901	Pulley, Sngl. Fixed, 1"	2 ea.
55902	Pulley, Sngl. Fixed, 1-1/4"	2 ea.
55903	Pulley, Sngl. Fixed, 1-1/2"	2 ea.
55904	Pulley, Sngl. Fixed, 2"	2 ea.
55906	Pulley, Dbl. Fixed, 3/4"	2 ea.
55907	Pulley, Dbl. Fixed, 1"	2 ea.
55908	Pulley, Dbl. Fixed, 1-1/2"	2 ea.
55909	Pulley, Dbl. Fixed, 2"	2 ea.
55915	Pulley, Sngl. Swivel, 3/4"	2 ea.
55916	Pulley, Sngl. Swivel, 1"	2 ea.
55917	Pulley, Sngl. Swivel, 1-1/4"	2 ea.
55918	Pulley, Sngl. Swivel, 1-1/2"	2 ea.
55919	Pulley, Sngl. Swivel, 2"	2 ea.
55925	Pulley, Dbl. Swivel, 3/4"	2 ea.
55926	Pulley, Dbl. Swivel, 1"	2 ea.
55927	Pulley, Dbl. Swivel, 1-1/4"	2 ea.
55928	Pulley, Dbl. Swivel, 1-1/2"	2 ea.



Aluminum Pulleys Merchandiser

PART#	CONTENTS
00335	Aluminum Pulley Display Boards Only , two 24" x 24"
00335K	Full Aluminum Pulleys Merchandiser . 36 part #'s, 72 pieces. Includes two 00335 display boards, 36 pegs (80004) and the products listed below:

PART#	DESCRIPTION	QTY.
55400	1-1/2" x 1/2"	2 ea.
55401	1-1/2" x 5/8"	2 ea.
55402	2" x 1/2"	2 ea.
55403	2" x 5/8"	2 ea.
55404	2" x 3/4"	2 ea.
55405	2-1/4" x 1/2"	2 ea.
55406	2-1/4" x 5/8"	2 ea.
55407	2-1/4" x 3/4"	2 ea.
55408	2-1/2" x 1/2"	2 ea.
55409	2-1/2" x 5/8"	2 ea.
55410	2-1/2" x 3/4"	2 ea.
55411	3" x 1/2"	2 ea.
55412	3" x 5/8"	2 ea.
55413	3" x 3/4"	2 ea.
55414	3-1/2" x 1/2"	2 ea.
55415	3-1/2" x 5/8"	2 ea.
55416	3-1/2" x 3/4"	2 ea.
55417	4" x 1/2"	2ea.
55418	4" x 5/8"	2 ea.
55419	4" x 3/4"	2 ea.
55420	4-1/2" x 1/2"	2 ea.
55421	4-1/2" x 5/8"	2 ea.
55422	4-1/2" x 3/4"	2 ea.
55423	5" x 1/2"	2 ea.
55424	5" x 5/8"	2 ea.
55425	5" x 3/4"	2 ea.
55426	6" x 1/2"	2 ea.
55427	6" x 5/8"	2 ea.
55428	6" x 3/4"	2 ea.
55429	7" x 1/2"	2 ea.
55430	7" x 5/8"	2 ea.
55431	7" x 3/4"	2 ea.
55434	8" x 3/4"	2 ea.
<i>VARIABLE SPEED PULLEYS:</i>		
55490	3-1/4" x 1/2"	2 ea.
55491	3-1/4" x 5/8"	2 ea.
55492	3-1/4" x 3/4"	2 ea.



Merchandisers



Turnbuckles Merchandiser - General Purpose

PART#	CONTENTS
00416	Turnbuckles Display Board Only , 12" x 24"
00416K	Full General Purpose Turnbuckles Merchandiser. 18 part #s, 132 pieces. Includes 00416 display board, 19 pegs (80004) and the products listed below:



PART#	DESCRIPTION	QUANTITY
66209	Hook & Eye, 3/8"	1 pkg. of 10
66210	Hook & Eye, 6mm	2 ea.
66211	Hook & Eye, 8mm	2 ea.
66212	Hook & Eye, 10mm	2 ea.
66213	Hook & Eye, 12mm	2 ea.
66214	Hook & Eye, 16mm	2 ea.
66215	Hook & Eye, 20mm	2 ea.
66216	Hook & Hook, 7/32"	1 pkg. of 10
66217	Hook & Hook, 1/4"	1 pkg. of 10
66218	Hook & Hook, 5/16"	1 pkg. of 10
66219	Hook & Hook, 3/8"	1 pkg. of 10
66226	Eye & Eye, 7/32"	1 pkg. of 10
66227	Eye & Eye, 1/4"	1 pkg. of 10
66228	Eye & Eye, 5/16"	1 pkg. of 10
66229	Eye & Eye, 3/8"	1 pkg. of 10

PART#	DESCRIPTION	QUANTITY
66206	Hook & Eye, 7/32"	1 pkg. of 10
66207	Hook & Eye, 1/4"	1 pkg. of 10
66208	Hook & Eye, 5/16"	1 pkg. of 10

Turnbuckles Merchandiser - Forged Steel

PART#	CONTENTS
00417	Forged Steel Turnbuckles Display Board Only , 24" x 24"
00417K	Full Forged Steel Turnbuckles Merchandiser. 29 part #s, 174 pieces. Includes 00417 display board, 30 pegs (80004) and the products listed below:



PART#	DESCRIPTION	QUANTITY
66227	Eye & Eye, 1/4"	1 pkg. of 10
66228	Eye & Eye, 5/16"	1 pkg. of 10
66229	Eye & Eye, 3/8"	1 pkg. of 10
66800	Hook & Hook, 1/4" x 4"	4 ea.
66801	Hook & Hook, 5/16" x 4-1/2"	4 ea.
66802	Hook & Hook, 3/8" x 6"	4 ea.
66803	Hook & Hook, 1/2" x 6"	4 ea.
66820	Hook & Eye, 1/4" x 4"	4 ea.
66821	Hook & Eye, 5/16" x 4-1/2"	4 ea.
66822	Hook & Eye, 3/8" x 6"	4 ea.
66823	Hook & Eye, 1/2" x 6"	4 ea.
66830	Eye & Eye, 1/4" x 4"	4 ea.
66831	Eye & Eye, 5/16" x 4-1/2"	4 ea.
66832	Eye & Eye, 3/8" x 6"	4 ea.
66833	Eye & Eye, 1/2" x 6"	4 ea.
66840	Jaw & Jaw, 1/4" x 4"	4 ea.
66841	Jaw & Jaw, 5/16" x 4-1/2"	4 ea.
66842	Jaw & Jaw, 3/8" x 6"	4 ea.
66843	Jaw & Jaw, 1/2" x 6"	4 ea.

PART#	DESCRIPTION	QUANTITY
66206	Hook & Eye, 7/32"	1 pkg. of 10
66207	Hook & Eye, 1/4"	1 pkg. of 10
66209	Hook & Eye, 3/8"	1 pkg. of 10
66210	Hook & Eye, 6mm	6 ea.
66211	Hook & Eye, 8mm	6 ea.
66212	Hook & Eye, 10mm	6 ea.
66213	Hook & Eye, 12mm	6 ea.
66214	Hook & Eye, 16mm	6 ea.
66219	Hook & Hook, 3/8"	1 pkg. of 10
66226	Eye & Eye, 7/32"	1 pkg. of 10

Merchandisers



Bronze Bushings Merchandiser

PART#	CONTENTS
00325	Bronze Bushings Display Board Only , 12" x 24"
00325K	Full Bronze Bushings Merchandiser . 51 part #'s, 79 pieces. Includes 00325 display board, 51 pegs (80004) and products listed below:

PART#	INS. DIA.	OUT. DIA.	QTY.	PART#	INS. DIA.	OUT. DIA.	QTY.
55300	1/4"	5/16"	2 ea.	55336	1-1/8"	1-1/2"	1 ea.
55301	1/4"	3/8"	2 ea.	55337	1-3/16"	1-7/16"	1 ea.
55302	1/4"	7/16"	2 ea.	55338	1-3/16"	1-1/2"	1 ea.
55303	1/4"	1/2"	2 ea.	55339	1-1/4"	1-1/2"	1 ea.
55304	5/16"	3/8"	2 ea.	55340	1-1/4"	1-5/8"	1 ea.
55305	5/16"	7/16"	2 ea.	55341	1-3/8"	1-5/8"	1 ea.
55306	3/8"	1/2"	2 ea.	55342	1-3/8"	1-3/4"	1 ea.
55307	3/8"	5/8"	2 ea.	55343	1-7/16"	1-3/4"	1 ea.
55308	3/8"	3/4"	2 ea.	55344	1-1/2"	1-3/4"	1 ea.
55309	7/16"	9/16"	1 ea.	55345	1-1/2"	1-7/8"	1 ea.
55310	7/16"	5/8"	2 ea.	55346	1-5/8"	2"	1 ea.
55311	1/2"	5/8"	2 ea.	55347	1-3/4"	2"	1 ea.
55312	1/2"	11/16"	2 ea.	55348	1-3/4"	2-1/8"	1 ea.
55313	1/2"	3/4"	2 ea.	55349	2"	2-1/4"	1 ea.
55314	1/2"	13/16"	2 ea.	55350	2"	2-3/8"	1 ea.
55315	1/2"	7/8"	2 ea.				
55316	9/16"	3/4"	2 ea.				
55317	9/16"	13/16"	2 ea.				
55318	5/8"	3/4"	2 ea.				
55319	5/8"	13/16"	2 ea.				
55320	5/8"	7/8"	2 ea.				
55321	5/8"	1"	2 ea.				
55322	3/4"	7/8"	2 ea.				
55323	3/4"	15/16"	1 ea.				
55324	3/4"	1"	2 ea.				
55325	13/16"	1"	1 ea.				
55326	7/8"	1"	2 ea.				
55327	7/8"	1-1/8"	1 ea.				
55328	7/8"	1-1/4"	2 ea.				
55329	15/16"	1-1/4"	1 ea.				
55330	1"	1-1/4"	2 ea.				
55331	1"	1-3/8"	2 ea.				
55332	1"	1-1/2"	2 ea.				
55333	1-1/16"	1-5/16"	1 ea.				
55334	1-1/8"	1-1/4"	1 ea.				
55335	1-1/8"	1-3/8"	1 ea.				



Reference Chart Available
See end of catalogue



Merchandisers



Snaps Merchandiser

PART#	CONTENTS
00447	Snaps Display Board Only , 12" x 24"
00447K	Full Snaps Merchandiser . 27 part #s, 145 pieces. Includes 00447 display board, 33 pegs (80004) and products listed below:

PART#	DESCRIPTION	QUANTITY
64072	Stainless Steel Snap Link, 5/16"	1 pkg. of 5
66331	Solid Snap Hook, 11/16"	1 pkg. of 5
66334	Swivel Eye Snap, 11/16"	1 pkg. of 5
66335	Swivel Eye Snap, 13/16"	1 pkg. of 5
66336	Dog Lead Snap, 3/8"	1 pkg. of 5
66338	Panic Snap, 1/2"	1 pkg. of 5
66339	Trigger Snap, 5/8"	1 pkg. of 5
66340	Bolt Snap, 11/16"	1 pkg. of 5
66341	Open Eye Snap, 13/16"	1 pkg. of 5
66343	Bolt Snap, 3/4"	1 pkg. of 5
66344	Trigger Snap, 3/4"	1 pkg. of 5
66348	Square Trigger Snap, 3/4"	1 pkg. of 5
66350	Trigger Snap, 13/16"	1 pkg. of 5
66354	Mini Bolt Snap, 7/16"	1 pkg. of 5
66360	Solid Brass Bolt Snap, 1/2" x 3"	1 pkg. of 5
66361	Brass Bolt Snap, 1"	1 pkg. of 5
66365	Baby Square Eye Snap, 5/8"	1 pkg. of 5
66366	Bolt Snap, 3-1/4"	1 pkg. of 5
66374	Lever Snap, 5/8"	1 pkg. of 5
66375	Lever Snap, 3/4"	1 pkg. of 5
66376	Lever Snap, 1"	1 pkg. of 5
66377	Lever Snap, 1-1/8"	1 pkg. of 5
66380	Security Snap, 7/8"	1 pkg. of 5
66381	Security Snap Hook, 7/8"	1 pkg. of 5
66387	Swivel Simplex Spring Snap, 1/2"	1 pkg. of 5
66427	Aluminum Snap Hook, 3/16"	1 pkg. of 10
66428	Aluminum Snap Hook, 1/4"	1 pkg. of 10



Merchandisers



Springs Merchandiser - Retail Packaged

PART#	CONTENTS
00242	Springs Display Boards Only . Includes two 24" x 24" full color boards.
00242K	Full Springs Merchandiser . 95 part #s, 190 pieces. Includes 00242 display boards, 100 pegs (80004) and products listed below:



A

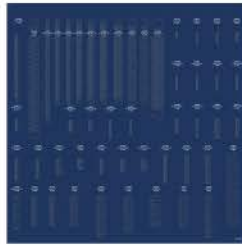

B



A



B



Extension Springs

PART#	REF#	QUANTITY	PART#	REF#	QUANTITY	PART#	REF#	QUANTITY
24001	C-1	2 pkg. of 2	24143	C-143	2 pkg. of 2	24253	C-253	2 ea.
24013	C-13	2 pkg. of 2	24155	C-155	2 pkg. of 2	24259	C-259	2 pkg. of 2
24019	C-19	2 pkg. of 2	24157	C-157	2 pkg. of 2	24261	C-261	2 ea.
24025	C-25	2 pkg. of 2	24161	C-161	2 pkg. of 2	24265	C-265	2 ea.
24029	C-29	2 pkg. of 2	24163	C-163	2 pkg. of 2	24269	C-269	2 ea.
24031	C-31	2 pkg. of 2	24165	C-165	2 pkg. of 2	24277	C-277	2 ea.
24033	C-33	2 pkg. of 2	24171	C-171	2 pkg. of 2	24293	C-293	2 ea.
24055	C-55	2 pkg. of 2	24173	C-173	2 pkg. of 2	24303	C-303	2 ea.
24069	C-69	2 pkg. of 2	24175	C-175	2 pkg. of 2	24311	C-311	2 ea.
24073	C-73	2 pkg. of 2	24177	C-177	2 pkg. of 2	24313	C-313	2 ea.
24077	C-77	2 pkg. of 2	24179	C-179	2 pkg. of 2	24315	C-315	2 ea.
24081	C-81	2 pkg. of 2	24181	C-181	2 pkg. of 2	24319	C-319	2 ea.
24083	C-83	2 pkg. of 2	24183	C-183	2 pkg. of 2	24321	C-321	2 ea.
24105	C-105	2 pkg. of 2	24187	C-187	2 pkg. of 2	24323	C-323	2 ea.
24115	C-115	2 pkg. of 2	24189	C-189	2 pkg. of 2	24325	C-325	2 ea.
24119	C-119	2 pkg. of 2	24215	C-215	2 pkg. of 2	24329	C-329	2 ea.
24131	C-131	2 pkg. of 2	24219	C-219	2 pkg. of 2	24337	C-337	2 ea.
24133	C-133	2 pkg. of 2	24231	C-231	2 pkg. of 2	24339	C-339	2 ea.
24135	C-135	2 pkg. of 2	24239	C-239	2 pkg. of 2			
24141	C-141	2 pkg. of 2	24243	C-243	2 pkg. of 2			

Compression Springs

PART#	REF#	QUANTITY	PART#	REF#	QUANTITY	PART#	REF#	QUANTITY
24510	C-510	2 pkg. of 6	24652	C-652	2 pkg. of 4	24730	C-730	2 pkg. of 2
24516	C-516	2 pkg. of 6	24660	C-660	2 pkg. of 4	24736	C-736	2 pkg. of 2
24526	C-526	2 pkg. of 6	24664	C-664	2 pkg. of 4	24742	C-742	2 pkg. of 2
24566	C-566	2 pkg. of 6	24668	C-668	2 pkg. of 4	24756	C-756	2 pkg. of 2
24580	C-580	2 pkg. of 6	24672	C-672	2 pkg. of 4	24766	C-766	2 pkg. of 2
24582	C-582	2 pkg. of 6	24676	C-676	2 pkg. of 4	24782	C-782	2 pkg. of 2
24608	C-608	2 pkg. of 4	24680	C-680	2 pkg. of 4	24792	C-792	2 pkg. of 2
24612	C-612	2 pkg. of 4	24692	C-692	2 pkg. of 2	24822	C-822	2 pkg. of 2
24614	C-614	2 pkg. of 4	24702	C-702	2 pkg. of 2	24826	C-826	2 pkg. of 2
24624	C-624	2 pkg. of 4	24704	C-704	2 pkg. of 2	24830	C-830	2 pkg. of 2
24632	C-632	2 pkg. of 4	24706	C-706	2 pkg. of 2	24832	C-832	2 pkg. of 2
24650	C-650	2 pkg. of 4	24712	C-712	2 pkg. of 2	24836	C-836	2 pkg. of 2
						24892	C-892	2 ea.



Merchandisers



Springs - Expanded Selection 1

PART#	CONTENTS
00244	Springs Display Board Only , 24" x 24"
00244K	Full Springs Merchandiser Expansion 1 for 00242K. 34 part #s, 34 pieces. Includes 00244 display board, 34 pegs (80004) and products listed below:

Extension Springs

PART#	REF#	QUANTITY	PART#	REF#	QUANTITY
24139	C-139	1 pkg. of 2	24235	C-235	1 pkg. of 2
24185	C-185	1 pkg. of 2	24251	C-251	1 ea.
24191	C-191	1 pkg. of 2	24257	C-257	1 pkg. of 2
24193	C-193	1 pkg. of 2	24263	C-263	1 ea.
24221	C-221	1 pkg. of 2	24271	C-271	1 ea.
24223	C-223	1 pkg. of 2	24273	C-273	1 ea.
24227	C-227	1 pkg. of 2	24275	C-275	1 ea.
24233	C-233	1 pkg. of 2	24301	C-301	1 ea.

Compression Springs

PART#	REF#	QUANTITY	PART#	REF#	QUANTITY
24556	C-556	1 pkg. of 6	24802	C-802	1 ea.
24562	C-562	1 pkg. of 6	24806	C-806	1 ea.
24700	C-700	1 pkg. of 2	24814	C-814	1 ea.
24720	C-720	1 pkg. of 2	24838	C-818	1 pkg. of 2
24722	C-722	1 pkg. of 2	24850	C-850	1 pkg. of 2
24724	C-724	1 pkg. of 2	24856	C-856	1 pkg. of 2
24740	C-740	1 pkg. of 2	24858	C-858	1 pkg. of 2
24750	C-750	1 pkg. of 2	24864	C-864	1 ea.
24752	C-752	1 pkg. of 2	24874	C-874	1 ea.



Springs - Expanded Selection 2

PART#	CONTENTS
00248	Springs Display Board Only , 24" x 24"
00248K	Full Springs Merchandiser Expansion 2 for 00242K. 36 part #s, 56 pieces. Includes 00248 display board, 36 pegs (80004) and products listed below:

Extension Springs

PART#	REF#	QUANTITY	PART#	REF#	QUANTITY
00248	-	1 ea.	24209	C-209	1 ea.
24005	C-5	1 pkg. of 2	24267	C-267	1 ea.
24023	C-23	1 pkg. of 2	24281	C-281	1 ea.
24051	C-51	1 pkg. of 2	24285	C-285	1 ea.
24063	C-63	1 pkg. of 2	24287	C-287	1 ea.
24067	C-67	1 pkg. of 2	24289	C-289	1 ea.
24103	C-103	1 pkg. of 2	24307	C-307	1 ea.
24111	C-111	1 pkg. of 2	24317	C-317	1 ea.
24117	C-117	1 pkg. of 2	24333	C-333	1 ea.
24205	C-205	1 ea.			

Compression Springs

PART#	REF#	QUANTITY	PART#	REF#	QUANTITY
24500	C-500	2 pkg. of 6	24600	C-600	2 pkg. of 4
24520	C-520	2 pkg. of 6	24604	C-604	2 pkg. of 4
24530	C-530	2 pkg. of 6	24690	C-690	1 pkg. of 2
24532	C-532	2 pkg. of 6	24714	C-714	2 pkg. of 2
24550	C-550	2 pkg. of 6	24768	C-768	1 pkg. of 2
24554	C-554	2 pkg. of 6	24818	C-818	1 pkg. of 2
24570	C-570	2 pkg. of 6	24834	C-834	1 pkg. of 2
24576	C-576	2 pkg. of 6	24878	C-878	1 ea.
24578	C-578	2 pkg. of 6	24900	4001	1 ea.

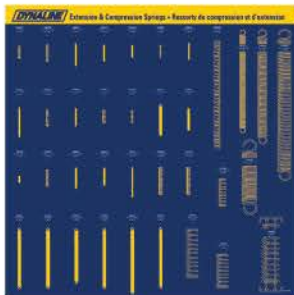



Retainer Rings Merchandiser

PART#	CONTENTS
00245	Retainer Rings Display Board Only , 24" x 24"
00245K	Full Retainer Rings Merchandiser . 87 part #s, 763 pieces. Includes 00245 display board, cornice hooks (65043) and products listed below:

PART#	DESCRIPTION	REF. #	QUANTITY
22861	"E" type, 3/16"	R1000-018	1 pkg. of 10
22862	"E" type, 1/4"	R1000-025	1 pkg. of 10
22863	"E" type, 5/16"	R1000-031	1 pkg. of 10
22864	"E" type, 3/8"	R1000-037	1 pkg. of 10
22865	"E" type, 7/16"	R1000-043	1 pkg. of 10
22866	"E" type, 1/2"	R1000-050	1 pkg. of 10
22867	"E" type, 5/8"	R1000-062	1 pkg. of 10
22868	"E" type, 3/4"	R1000-075	1 pkg. of 10
22869	"E" type, 7/8"	R1000-087	1 pkg. of 10
22870	"E" type, 63/64"	R1000-098	1 pkg. of 10
22871	"E" type, 1-3/16"	R1000-118	1 pkg. of 10
22872	"E" type, 1-3/8"	R1000-137	1 pkg. of 10
22873	Int., 1/4"	R3000-025	1 pkg. of 10
22874	Int., 5/16"	R3000-031	1 pkg. of 10
22875	Int., 3/8"	R3000-037	1 pkg. of 10
22876	Int., 7/16"	R3000-043	1 pkg. of 10
22878	Int., 1/2"	R3000-050	1 pkg. of 10
22879	Int., 9/16"	R3000-056	1 pkg. of 10
22880	Int., 5/8"	R3000-062	1 pkg. of 10
22881	Int., 11/16"	R3000-068	1 pkg. of 10
22882	Int., 3/4"	R3000-075	1 pkg. of 10
22884	Int., 7/8"	R3000-087	1 pkg. of 10
22885	Int., 15/16"	R3000-093	1 pkg. of 10
22886	Int., 1"	R3000-100	1 pkg. of 10
22888	Int., 1-1/16"	R3000-106	1 pkg. of 10
22889	Int., 1-1/8"	R3000-112	1 pkg. of 10
22890	Int., 1-3/16"	R3000-118	1 pkg. of 10
22891	Int., 1-1/4"	R3000-125	1 pkg. of 10
22892	Int., 1-5/16"	R3000-131	1 pkg. of 10
22893	Int., 1-3/8"	R3000-137	1 pkg. of 10
22894	Int., 1-7/16"	R3000-143	1 pkg. of 10
22895	Int., 1-1/2"	R3000-150	1 pkg. of 10
22896	Int., 1-9/16"	R3000-156	1 pkg. of 10
22897	Int., 1-5/8"	R3000-162	1 pkg. of 10
22900	Int., 1-3/4"	R3000-175	1 pkg. of 10
22901	Int., 1-13/16"	R3000-181	1 pkg. of 10
22902	Int., 1-7/8"	R3000-187	1 pkg. of 10
22903	Int., 1-15/16"	R3000-193	1 pkg. of 10
22904	Int., 2"	R3000-200	1 pkg. of 10
22905	Int., 2-1/16"	R3000-206	1 pkg. of 5
22906	Int., 2-1/8"	R3000-212	1 pkg. of 5

PART#	DESCRIPTION	REF. #	QUANTITY
22907	Int., 2-1/4"	R3000-225	1 pkg. of 5
22908	Int., 2-3/8"	R3000-237	1 pkg. of 5
22909	Int., 2-7/16"	R3000-244	1 pkg. of 5
22910	Int., 2-1/2"	R3000-250	1 pkg. of 5
22912	Int., 2-11/16"	R3000-268	1 pkg. of 5
22913	Int., 2-3/4"	R3000-275	1 pkg. of 5
22914	Int., 2-13/16"	R3000-281	1 pkg. of 5
22916	Int., 3"	R3000-300	1 pkg. of 2
22926	Ext., 5/16"	R3100-031	1 pkg. of 10
22928	Ext., 3/8"	R3100-037	1 pkg. of 10
22929	Ext., 7/16"	R3100-043	1 pkg. of 10
22931	Ext., 1/2"	R3100-050	1 pkg. of 10
22932	Ext., 9/16"	R3100-056	1 pkg. of 10
22933	Ext., 19/32"	R3100-059	1 pkg. of 10
22934	Ext., 5/8"	R3100-062	1 pkg. of 10
22935	Ext., 5/8"	R3100-066	1 pkg. of 10
22936	Ext., 11/16"	R3100-068	1 pkg. of 10
22937	Ext., 3/4"	R3100-075	1 pkg. of 10
22938	Ext., 13/16"	R3100-081	1 pkg. of 10
22939	Ext., 7/8"	R3100-087	1 pkg. of 10
22940	Ext., 15/16"	R3100-093	1 pkg. of 10
22942	Ext., 1"	R3100-100	1 pkg. of 10
22944	Ext., 1-1/16"	R3100-106	1 pkg. of 10
22945	Ext., 1-1/8"	R3100-112	1 pkg. of 10
22946	Ext., 1-3/16"	R3100-118	1 pkg. of 10
22947	Ext., 1-1/4"	R3100-125	1 pkg. of 10
22948	Ext., 1-5/16"	R3100-131	1 pkg. of 10
22949	Ext., 1-3/8"	R3100-137	1 pkg. of 10
22950	Ext., 1-7/16"	R3100-143	1 pkg. of 10
22951	Ext., 1-1/2"	R3100-150	1 pkg. of 10
22952	Ext., 1-9/16"	R3100-156	1 pkg. of 10
22953	Ext., 1-5/8"	R3100-162	1 pkg. of 10
22954	Ext., 1-11/16"	R3100-168	1 pkg. of 10
22955	Ext., 1-3/4"	R3100-175	1 pkg. of 10
22956	Ext., 1-7/8"	R3100-187	1 pkg. of 10
22957	Ext., 1-31/32"	R3100-196	1 pkg. of 10
22958	Ext., 2"	R3100-200	1 pkg. of 10
22960	Ext., 2-1/8"	R3100-212	1 pkg. of 5
22962	Ext., 2-1/4"	R3100-225	1 pkg. of 5
22963	Ext., 2-3/8"	R3100-237	1 pkg. of 5
22964	Ext., 2-7/16"	R3100-243	1 pkg. of 5
22965	Ext., 2-1/2"	R3100-250	1 pkg. of 5
22966	Ext., 2-5/8"	R3100-262	1 pkg. of 5
22967	Ext., 2-3/4"	R3100-275	1 pkg. of 2
22968	Ext., 2-7/8"	R3100-287	1 pkg. of 2
22970	Ext., 3"	R3100-300	1 pkg. of 2



Reference Chart Available
 See end of catalogue



Retainer Rings Tilt Bins Merchandiser

PART#	CONTENTS
-------	----------

00746K Full Retainer Rings Tilt Bin Merchandiser. 64 part #s, 625 pieces. Dimensions: 23-5/8" x 2-1/2" x 26-1/2"
Includes Tilt Bins, assembly hardware and products listed below:

PART#	DESCRIPTION	QTY.
22860	R1000-012	1 pkg. of 10
22861	R1000-018	1 pkg. of 10
22862	R1000-025	1 pkg. of 10
22863	R1000-031	1 pkg. of 10
22864	R1000-037	1 pkg. of 10
22865	R1000-043	1 pkg. of 10
22866	R1000-050	1 pkg. of 10
22867	R1000-062	1 pkg. of 10
22868	R1000-075	1 pkg. of 10
22869	R1000-087	1 pkg. of 10
22870	R1000-098	1 pkg. of 10
22873	R3000-025	1 pkg. of 10
22874	R3000-031	1 pkg. of 10
22875	R3000-037	1 pkg. of 10
22876	R3000-043	1 pkg. of 10
22878	R3000-050	1 pkg. of 10
22879	R3000-056	1 pkg. of 10
22880	R3000-062	1 pkg. of 10
22881	R3000-068	1 pkg. of 10
22882	R3000-075	1 pkg. of 10
22884	R3000-087	1 pkg. of 10
22886	R3000-100	1 pkg. of 10
22888	R3000-106	1 pkg. of 10
22889	R3000-112	1 pkg. of 10
22893	R3000-137	1 pkg. of 10
22895	R3000-150	1 pkg. of 10
22896	R3000-156	1 pkg. of 10
22897	R3000-162	1 pkg. of 10
22900	R3000-175	1 pkg. of 10
22901	R3000-181	1 pkg. of 10
22903	R3000-193	1 pkg. of 10
22904	R3000-200	1 pkg. of 10
22906	R3000-212	1 pkg. of 5
22907	R3000-225	1 pkg. of 5
22924	R3100-018	1 pkg. of 10
22925	R3100-025	1 pkg. of 10
22926	R3100-031	1 pkg. of 10
22928	R3100-037	1 pkg. of 10
22929	R3100-043	1 pkg. of 10
22931	R3100-050	1 pkg. of 10
22932	R3100-056	1 pkg. of 10



Reference Chart Available

See end of catalogue

For empty tilt bins, see the end of this merchandiser section.

PART#	DESCRIPTION	QTY.
22933	R3100-059	1 pkg. of 10
22934	R3100-062	1 pkg. of 10
22936	R3100-068	1 pkg. of 10
22937	R3100-075	1 pkg. of 10
22938	R3100-081	1 pkg. of 10
22939	R3100-087	1 pkg. of 10
22940	R3100-093	1 pkg. of 10
22942	R3100-100	1 pkg. of 10
22944	R3100-106	1 pkg. of 10
22945	R3100-112	1 pkg. of 10
22946	R3100-118	1 pkg. of 10
22947	R3100-125	1 pkg. of 10
22948	R3100-131	1 pkg. of 10
22949	R3100-137	1 pkg. of 10
22950	R3100-143	1 pkg. of 10
22951	R3100-150	1 pkg. of 10
22952	R3100-156	1 pkg. of 10
22953	R3100-162	1 pkg. of 10
22954	R3100-168	1 pkg. of 10
22955	R3100-175	1 pkg. of 10
22956	R3100-187	1 pkg. of 10
22958	R3100-200	1 pkg. of 10
22965	R3100-250	1 pkg. of 5
TF308	Tilt Bin 8 Comp.	8 ea.



Merchandisers



Machinery Bushings Merchandiser

PART#	CONTENTS
00235	Machinery Bushings Display Board Only , 12" x 24"
00235K	Full Machinery Bushings Merchandiser . 39 part #s, 390 pieces. Includes 00235 display board, 39 pegs (80004) and the products listed below:



Reference Chart Available
 See end of catalogue



PART#	DESCRIPTION	QUANTITY	PART#	DESCRIPTION	QUANTITY	PART#	DESCRIPTION	QUANTITY
22700	M-16-L	1 pkg. of 10	22713	M-28-H	1 pkg. of 10	22726	M-40-H	1 pkg. of 10
22701	M-18-L	1 pkg. of 10	22714	M-30-L	1 pkg. of 10	22727	M-46-M	1 pkg. of 10
22702	M-18-M	1 pkg. of 10	22715	M-30-M	1 pkg. of 10	22728	M-46-H	1 pkg. of 10
22703	M-20-L	1 pkg. of 10	22716	M-30-H	1 pkg. of 10	22729	M-48-M	1 pkg. of 10
22704	M-20-M	1 pkg. of 10	22717	M-34-L	1 pkg. of 10	22730	M-48-H	1 pkg. of 10
22705	M-20-H	1 pkg. of 10	22718	M-34-M	1 pkg. of 10	22731	M-50-M	1 pkg. of 10
22706	M-22-L	1 pkg. of 10	22719	M-34-H	1 pkg. of 10	22732	M-50-H	1 pkg. of 10
22707	M-22-M	1 pkg. of 10	22720	M-36-L	1 pkg. of 10	22733	M-52-M	1 pkg. of 10
22708	M-24-L	1 pkg. of 10	22721	M-36-M	1 pkg. of 10	22734	M-52-H	1 pkg. of 10
22709	M-24-M	1 pkg. of 10	22722	M-36-H	1 pkg. of 10	22735	M-54-M	1 pkg. of 10
22710	M-24-H	1 pkg. of 10	22723	M-38-M	1 pkg. of 10	22736	M-54-H	1 pkg. of 10
22711	M-28-L	1 pkg. of 10	22724	M-38-H	1 pkg. of 10	22737	M-56-M	1 pkg. of 10
22712	M-28-M	1 pkg. of 10	22725	M-40-M	1 pkg. of 10	22738	M-56-H	1 pkg. of 10

Keystock

PART#	CONTENTS
00285	Keystock Bin only . 8 compartments, made of durable blue plastic. Dimensions: 10" x 9-1/8" x 1-1/2"

PART#	CONTENTS
00255K	Full Square Keystock Merchandiser 12" long. 8 part #'s, 37 pieces. Includes 00285 Keystock Bin and the products listed below:

PART#	DESCRIPTION	QTY.	PART#	DESCRIPTION	QTY.
22750	1/8"	1 pkg. of 5	22754	3/8"	1 pkg. of 5
22751	3/16"	1 pkg. of 5	22755	7/16"	1 pkg. of 5
22752	1/4"	1 pkg. of 5	22756	1/2"	1 pkg. of 5
22753	5/16"	1 pkg. of 5	22758	5/8"	1 pkg. of 2

PART#	CONTENTS
00265K	Full Rectangular Keystock Merchandiser . 12" long. 8 part #'s, 37 pieces. Includes 00285 Keystock Bin.

PART#	DESCRIPTION	QTY.	PART#	DESCRIPTION	QTY.
22782	3/16" x 1/4"	1 pkg. of 5	22791	3/8" x 7/16"	1 pkg. of 5
22785	1/4" x 5/16"	1 pkg. of 5	22792	3/8" x 1/2"	1 pkg. of 5
22786	1/4" x 3/8"	1 pkg. of 5	22795	7/16" x 1/2"	1 pkg. of 5
22789	5/16" x 3/8"	1 pkg. of 5	22796	1/2" x 5/8"	1 pkg. of 2

PART#	CONTENTS
00275K	Full Step Keystock Merchandiser 12" long. 8 part #'s, 16 pieces. Includes 00285 Keystock Bin

PART#	DESCRIPTION	QTY.	PART#	DESCRIPTION	QTY.
22821	3/16" x 1/4"	1 pkg. of 2	22825	3/8" x 7/16"	1 pkg. of 2
22822	1/4" x 5/16"	1 pkg. of 2	22826	3/8" x 1/2"	1 pkg. of 2
22823	1/4" x 3/8"	1 pkg. of 2	22827	7/16" x 1/2"	1 pkg. of 2
22824	5/16" x 3/8"	1 pkg. of 2	22828	1/2" x 5/8"	1 pkg. of 2



Merchandisers



Pins Merchandiser

PART#	CONTENTS
00557	Pins Display Board Only, 24" x 24"
00557K	Full Pins Merchandiser. 52 part #s, 655 pieces. Includes 00557 display board, 53 pegs (80004) and the products listed below:



Merchandisers



00024 Compatible

PART#	DESCRIPTION	QTY.
66300	Hair Pin, HP-22	1 pkg. of 25
66301	Hair Pin, HP-3	1 pkg. of 25
66302	Hair Pin, HP-6	1 pkg. of 25
66303	Hair Pin, HP-7	1 pkg. of 25
66304	Hair Pin, HP-8	1 pkg. of 25
66305	Hair Pin, HP-9	1 pkg. of 25
66306	Hair Pin, HP-11	1 pkg. of 25
66307	Hair Pin, HP-16	1 pkg. of 25
66308	Hair Pin, HP-19	1 pkg. of 10
66309	Hair Pin, HP-1	1 pkg. of 25
66310	Hair Pin, HP-2	1 pkg. of 25
66311	Hair Pin, HP-7XX	1 pkg. of 25
66312	Hair Pin, HP-10X	1 pkg. of 25
66313	Hair Pin, HP-4	1 pkg. of 25
66317	Hair Pin, HP-17	1 pkg. of 25

PART#	DESCRIPTION	QTY.
66318	Hair Pin, HP-18	1 pkg. of 25
66320	Hair Pin, HP-20	1 pkg. of 10
66325	Hair Pin, HP-25	1 pkg. of 25
66326	Hair Pin, HP-10	1 pkg. of 25
66328	Hair Pin, HP-14	1 pkg. of 25
66450	Linch Pin, 3/16"	1 pkg. of 10
66451	Linch Pin, 1/4"	1 pkg. of 10
66452	Linch Pin, 5/16"	1 pkg. of 10
66453	Linch Pin, 3/8"	1 pkg. of 10
66454	Linch Pin, 7/16"	1 pkg. of 10
66455	Linch Pin, 7/16"	1 pkg. of 10
66460	Quick Pin, 1-3/8"	1 pkg. of 5
66461	Quick Pin, 1-3/4"	1 pkg. of 5
66462	Quick Pin, 2-1/2"	1 pkg. of 5
66463	Quick Pin, 1-3/8"	1 pkg. of 5
66464	Quick Pin, 1-3/4"	1 pkg. of 5
66465	Quick Pin, 2-1/2"	1 pkg. of 5
66466	Quick Pin, 1-3/8"	1 pkg. of 5
66467	Quick Pin, 2-1/4"	1 pkg. of 5
66468	Quick Pin, 2-1/2"	1 pkg. of 5
66470	Safety Pin, 3-1/8"	1 pkg. of 10
66472	Safety Pin, 3-3/8"	1 pkg. of 5
66474	Safety Pin, 5-1/4"	1 pkg. of 5
66489	Safety Pin, 1-11/16"	1 pkg. of 10
66490	Safety Pin, 2-13/16"	1 pkg. of 10
66491	Safety Pin, 3"	1 pkg. of 5
66492	Safety Pin, 3-3/4"	1 pkg. of 5
66493	Safety Pin, 5"	1 pkg. of 5
66494	Safety Pin, 5"	1 pkg. of 5
66531	Tab, 1/4" x 1-5/8"	1 pkg. of 5
66532	Tab, 1/4" x 2"	1 pkg. of 5
66533	Tab, 1/4" x 2-3/4"	1 pkg. of 5
66534	Tab, 5/16" x 1-5/8"	1 pkg. of 5
66535	Tab, 5/16" x 2"	1 pkg. of 5
66536	Tab, 5/16" x 2-3/4"	1 pkg. of 5
66537	Tab, 3/8" x 1-5/8"	1 pkg. of 5
66538	Tab, 3/8" x 2-1/2"	1 pkg. of 5
66539	Tab, 3/8" x 2-3/4"	1 pkg. of 5



Farm Hardware Merchandiser

PART#	CONTENTS
-------	----------

01101 Farm Hardware **Backdrop Only**, 48" x 48"

01101K **Full Farm Hardware Plan-o-gram**. 73 part #s, 409 pieces. Includes 01101 and the products listed below:

PART#	DESCRIPTION	QUANTITY
66029	Straight Clevis, 1/2"	2 ea.
66030	Straight Clevis, 5/8"	2 ea.
66031	Straight Clevis, 3/4"	2 ea.
66032	Straight Clevis, 7/8"	2 ea.
66033	Straight Clevis, 1"	2 ea.
66250	Hitch Pin, 3/8" x 3"	2 ea.
66251	Hitch Pin, 1/2" x 3-5/8" C/W Clip	2 ea.
66252	Hitch Pin, 5/8" x 4" C/W Clip	2 ea.
66253	Hitch Pin, 3/4" x 4-1/2" C/W Clip	2ea.
66254	Hitch Pin, 7/8" x 4-1/2" C/W Clip	2 ea.
66255	Hitch Pin, 1" x 4-1/2" C/W Clip	2 ea.
66256	Hitch Pin, 5/8" x 5-1/2" C/W Clip	2 ea.
66257	Hitch Pin, 3/4" x 6-1/2" C/W Clip	2 ea.
66258	Hitch Pin, 7/8" x 6-1/2" C/W Clip	2 ea.
66259	Hitch Pin, 1" x 7-1/2" C/W Clip	2 ea.
66260	Hitch Pin, 1-1/8" x 8-1/2"	2 ea.
66261	Hitch Pin, 1-1/4" x 8-1/2"	2 ea.
66263	Hitch Pin, 1-1/2" x 8-1/2"	2 ea.
66302	Hair Pin, HP-6	1 pkg. of 25
66303	Hair Pin, HP-7	1 pkg. of 25
66304	Hair Pin, HP-8	1 pkg. of 25
66305	Hair Pin, HP-9	1 pkg. of 25
66306	Hair Pin, HP-11	1 pkg. of 25
66308	Hair Pin, HP-19	1 pkg. of 10
66326	Hair Pin, HP-10	1 pkg. of 25
66450	Linch Pin, 3/16"	1 pkg. of 10
66451	Linch Pin, 1/4"	1 pkg. of 10
66452	Linch Pin, 5/16"	1 pkg. of 10
66453	Linch Pin, 3/8"	1 pkg. of 10
66454	Linch Pin, 7/16"	1 pkg. of 10
66455	Linch Pin, 7/16"	1 pkg. of 10
66460	Quick Pin, 1/4" x 1-3/8"	1 pkg. of 5
66461	Quick Pin, 1/4" x 1-3/4"	1 pkg. of 5
66462	Quick Pin, 1/4" x 2-1/2"	1 pkg. of 5
66463	Quick Pin, 5/16" x 1-3/8"	1 pkg. of 5
66464	Quick Pin, 5/16" x 1-3/4"	1 pkg. of 5
66465	Quick Pin, 5/16" x 2-1/2"	1 pkg. of 5
66466	Quick Pin, 3/8" x 1-3/8"	1 pkg. of 5
66467	Quick Pin, 3/8" x 2-1/4"	1 pkg. of 5
66468	Quick Pin, 3/8" x 2-1/2"	1 pkg. of 5
66470	Safety Pin, 1/8"	1 pkg. of 10

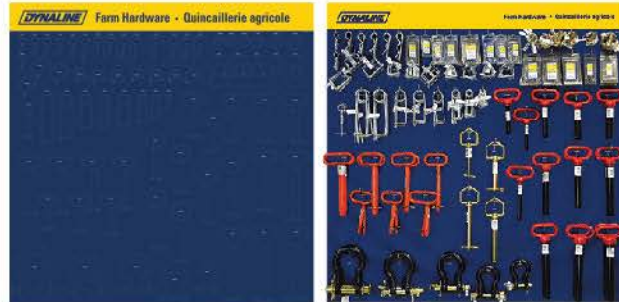

PART#	DESCRIPTION	QUANTITY
66472	Safety Pin, 3/16"	1 pkg. of 5
66474	Safety Pin, 1/4"	1 pkg. of 5
66489	Safety Pin, .091	1 pkg. of 10
66490	Safety Pin, 0.12	1 pkg. of 10
66491	Safety Pin, 0.177	1 pkg. of 5
66492	Safety Pin, 0.148	1 pkg. of 5
66493	Safety Pin, 0.243	1 pkg. of 5
66536	Tab Quick Pin Round, 5/16 x 2-3/4"	1 pkg. of 5
66780	Hitch Pin, 1/2" x 4-1/4"	2 ea.
66783	Hitch Pin, 3/4" x 4-1/4"	2 ea.
66784	Hitch Pin, 3/4" x 6-1/4"	2 ea.
66786	Hitch Pin, 1" x 6-1/4"	2 ea.
66872	E-Grip Hitch Pin, 1/2" x 3-1/2"	2 ea.
66873	E-Grip Hitch Pin, 5/8" x 3-3/4"	2 ea.
66874	E-Grip Hitch Pin, 3/4" x 4"	2 ea.
66875	E-Grip Hitch Pin, 5/8" x 6"	2 ea.
66876	E-Grip Hitch Pin, 3/4" x 6-1/4"	2 ea.
66877	E-Grip Hitch Pin, 7/8" x 6-1/2"	2 ea.
66878	E-Grip Hitch Pin, 1" x 6-3/4"	2 ea.
96300	Hair Pin Dynapak - 10 x 66300	2 ea.
96301	Hair Pin Dynapak - 10 x 66301	2 ea.
96302	Hair Pin Dynapak - 4 x 66302	2 ea.
96303	Hair Pin Dynapak - 10 x 66303	2 ea.
96304	Hair Pin Dynapak - 5 x 66304	2 ea.
96305	Hair Pin Dynapak - 5 x 66305	2 ea.
96306	Hair Pin Dynapak - 5 x 66306	2 ea.
96307	Hair Pin Dynapak - 10 x 66307	2 ea.
96450	Linch Pin Dynapak - 4 x 66450	2 ea.
96451	Linch Pin Dynapak - 4 x 66451	2 ea.
96460	Quick Pin Dynapak - 2 x 66460	2 ea.
96461	Quick Pin Dynapak - 2 x 66461	2 ea.
96464	Quick Pin Dynapak - 2 x 66464	2 ea.



Merchandisers





Merchandisers



Grade 8 Hitch Pins Merchandiser

PART#	CONTENTS
00439	Grade 8 Hitch Pins Display Board Only , 24" x 24"
00439K	Full Grade 8 Hitch Pins Merchandiser . 11 part #s, 21 pieces. Includes 00439 display board, 22 pegs (80004) and the products listed below:

PART#	DESCRIPTION	QTY.
66860	1/2" x 3-5/8"	2 ea.
66861	5/8" x 4"	2 ea.
66862	5/8" x 6"	2 ea.
66863	3/4" x 4"	2 ea.
66864	3/4" x 6-1/2"	2 ea.
66865	7/8" x 4-1/4"	2 ea.
66866	7/8" x 6-1/2"	2 ea.
66867	1" x 4-3/4"	2 ea.
66868	1" x 7"	2 ea.
66869	1-1/8" x 7"	2 ea.
66870	1-1/4" x 7"	1 ea.

E-Grip & Forged Steel Hitch Pins Merchandiser

PART#	CONTENTS
00441	E-Grip & Forged Steel Hitch Pins Display Board Only , 24"x 24"
00441K	Full E-Grip & Forged Steel Hitch Pins Merchandiser . 9 part #s, 18 pieces. Includes 00441 display board, 22 pegs (80004) and the products listed below:

PART#	DESCRIPTION	QTY.
66872	1/2" x 3-1/2"	2 ea.
66873	5/8" x 3-3/4"	2 ea.
66874	3/4" x 4"	2 ea.
66875	5/8" x 6"	2 ea.
66876	3/4" x 6-1/4"	2 ea.
66877	7/8" x 6-1/2"	2 ea.
66878	1" x 6-3/4"	2 ea.
66882	1-1/8" x 7"	1 ea.
66883	1-1/4" x 7"	1 ea.



Hitch Pins Merchandiser

PART#	CONTENTS
00435	Hitch Pins Display Board Only , 24" x 24"
00435K	Full Hitch Pins Merchandiser. 12 part #s, 22 pieces. Includes 00435 display board, 23 pegs (80004) and products listed below:

PART#	DESCRIPTION	QTY.
66250	3/8" x 3"	2 ea.
66251	1/2" x 3-5/8"	2 ea.
66252	5/8" x 4"	2 ea.
66253	3/4" x 4-1/2"	2 ea.
66254	7/8" x 4-1/2"	2 ea.
66255	1" x 4-1/2"	2 ea.
66256	5/8" x 5-1/2"	2 ea.
66257	3/4" x 6-1/2"	2 ea.
66258	7/8" x 6-1/2"	2 ea.
66259	1" x 7-1/2"	2 ea.
66260	1-1/8" x 8-1/2"	1 ea.
66261	1-1/4" x 8-1/2"	1 ea.



00024 Compatible

Hitch Pins (Fold Over Handle with Chain) Merchandiser

PART#	CONTENTS
00436	Hitch Pins (FOH) Display Board Only , 24" x 24"
00436K	"Fold Over Handle" Full Hitch Pins Merchandiser. 9 part #'s, 18 pieces. Includes 00436 display board, 9 pegs (80004) and the products listed below:

PART#	DESCRIPTION	QTY.
66280	1/2" x 4-1/4"	2 ea.
66281	5/8" x 4-1/4"	2 ea.
66282	5/8" x 6-1/4"	2 ea.
66283	3/4" x 4-1/4"	2 ea.
66284	3/4" x 6-1/4"	2 ea.
66285	7/8" x 6-1/4"	2 ea.
66286	1" x 6-1/4"	2 ea.
66287	1-1/8" x 6-1/4"	2 ea.
66288	1-1/4" x 6-1/4"	2 ea.

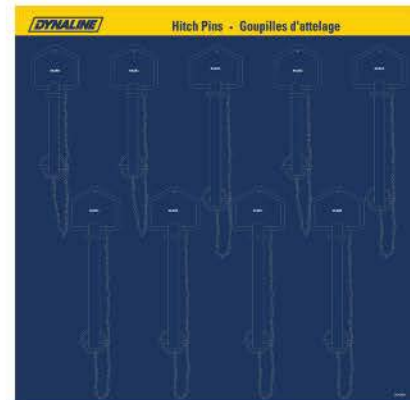

00024 Compatible



Merchandisers





Merchandisers



Tractor Linkage Parts Merchandiser

PART#	CONTENTS
00438	Tractor Linkage Display Board Only , 12" x 24"
00438K	Full Tractor Linkage Parts Merchandiser . 17 part #s, 34 pieces. Includes 00438 display board, 26 pegs (80004) and the products listed below:

PART#	DESCRIPTION	CAT.	QTY.
66560	Top Link Pin, 3/4"	1	2 ea.
66561	Top Link Pin, 3/4"	1	2 ea.
66562	Top Link Pin, 1"	2	2 ea.
66565	Top Link Pin, 1"	2	2 ea.
66580	Lift Arm Pin, 7/8"	1	2 ea.
66581	Lift Arm Pin, 7/8"	1	2 ea.
66582	Lift Arm Pin, 7/8"	1	2 ea.
66583	Lift Arm Pin, 1-1/8"	1-2	2 ea.
66585	Lift Arm Pin, 1-1/8"	1-2	2 ea.
66587	Lift Arm Pin, 7/8"	2-1	2 ea.
66588	Lift Arm Pin, 1-1/8"	2	2 ea.
66590	Lift Arm Pin, 7/8"	1	2 ea.
66602	Top Link Bushing, 3/4"	1-2 Long	2 ea.
66604	Top Link Bushing, 1"	2-3	2 ea.
66608	Lift Arm Bushing, 7/8"	1-2	2 ea.
66610	Lift Arm Bushing, 1-1/8"	2-3	2 ea.
66612	Lift Arm Bushing, 1-1/8"	2-3 Long	2 ea.

Stroke Control Merchandiser

PART#	CONTENTS
00297	Stroke Control Display Board Only , 12" x 24"
00297K	Full Stroke Control Merchandiser . 14 part #s, 28 pieces. Includes 00297 display board, 17 pegs (80004) and the products listed below:

PART#	DESCRIPTION	QTY.
80004	Rod Rd - 1/4 x 6-1/2"	16
55003	Stroke Control 1-1/4 x 3/4	2 ea.
55004	Stroke Control 1-1/4 x 1	2 ea.
55005	Stroke Control 1-1/4 x 1-1/4	2 ea.
55006	Stroke Control 1-1/4 x 1-1/2	2 ea.
55007	Stroke Control 1-1/2 x 3/4	2 ea.
55008	Stroke Control 1-1/2 x 1	2 ea.
55009	Stroke Control 1-1/2 x 1-1/4	2 ea.
55010	Stroke Control 1-1/2 x 1-1/2	2 ea.
55011	Stroke Control 2 x 1	2 ea.
55012	Stroke Control 2 x 1-1/2	2 ea.
55013	Stroke Control 2 x 2	2 ea.
55014	Stroke Control 2 x 4-1/4	2 ea.
55030	Cylinder Pin 1 x 2-3/4	2 ea.
55031	Cylinder Pin 1 x 3	2 ea.



Weather Caps Merchandiser

PART#	CONTENTS
00226	Weather Caps Display Board Only , 24" x 24"
00226K	Full Weather Caps Merchandiser . 11 part #s, 23 pieces. Includes 00226 display board, 26 pegs (80004) and the products listed below:

PART#	DESCRIPTION	QTY.
11200	1-1/2"	2 ea.
11201	1-3/4"	2 ea.
11202	2"	2 ea.
11203	2-1/4"	2 ea.
11204	2-1/2"	2 ea.
11205	2-3/4"	2 ea.
11206	3"	4 ea.
11207	3-1/2"	4 ea.
11208	4"	1 ea.
11209	4-1/2"	1 ea.
11210	5"	1 ea.



Farm Packs Merchandiser

PART#	CONTENTS
00620	Farm Packs Display Board Only , 24" x 24"
00620K	Full Farm Packs Merchandiser . 36 part #s, 144 pieces. Includes 00620 display board, 37 pegs (80004) and the products listed below:

PART#	DESCRIPTION	QTY.	PART#	DESCRIPTION	QTY.
92500	Clevis Pin, 1/4 x 1"	4 pkgs.	96455	Linch Pin Dynapak, 7/16"	4 pkgs.
92502	Clevis Pin, 1/4 x 1-1/2"	4 pkgs.	96460	Quick Pin Dynapak, 1-3/8"	4 pkgs.
92504	Clevis Pin, 1/4 x 2"	4 pkgs.	96461	Quick Pin Dynapak, 1-3/4"	4 pkgs.
92509	Clevis Pin, 5/16 x 1"	4 pkgs.	96462	Quick Pin Dynapak, 2-1/2"	4 pkgs.
92513	Clevis Pin, 5/16 x 2"	4 pkgs.	96463	Quick Pin Dynapak, 1-3/8"	4 pkgs.
96300	Hair Pin Dynapak, 1/4"	4 pkgs.	96464	Quick Pin Dynapak, 1-3/4"	4 pkgs.
96301	Hair Pin Dynapak, 7/16"	4 pkgs.	96465	Quick Pin Dynapak, 2-1/2"	4 pkgs.
96302	Hair Pin Dynapak, 7/8"	4 pkgs.	96466	Quick Pin Dynapak, 1-3/8"	4 pkgs.
96303	Hair Pin Dynapak, 5/8"	4 pkgs.	96467	Quick Pin Dynapak, 2-1/4"	4 pkgs.
96304	Hair Pin Dynapak, 7/8"	4 pkgs.	96468	Quick Pin Dynapak, 2-1/2"	4 pkgs.
96305	Hair Pin Dynapak, 3/4"	4 pkgs.	96469	Quick Pin Dynapak, 3-1/8"	4 pkgs.
96306	Hair Pin Dynapak, 9/16"	4 pkgs.	97072	Cable Stop Dynapak	4 pkgs.
96307	Hair Pin Dynapak, 1/2"	4 pkgs.	97074	Cable Stop Dynapak	4 pkgs.
96308	Hair Pin Dynapak, 3/4"	4 pkgs.	97081	Ferrule Dynapak	4 pkgs.
96311	Hair Pin Dynapak, 7/16"	4 pkgs.	97082	Ferrule Dynapak	4 pkgs.
96450	Linch Pin Dynapak, 3/16"	4 pkgs.	97083	Ferrule Dynapak	4 pkgs.
96451	Linch Pin Dynapak, 1/4"	4pkgs.	97084	Ferrule Dynapak	4 pkgs.
96452	Linch Pin Dynapak, 5/16"	4 pkgs.			
96453	Linch Pin Dynapak, 3/8"	4 pkgs.			
96454	Linch Pin Dynapak, 7/16"	4 pkgs.			





Merchandisers

Caster Wheels Plan-O-Gram

PART#	CONTENTS
00300K	Full Caster Wheels Plan-O-Gram. 28 part #s, 176 pieces. Includes header and the products listed below:

PART#	DESCRIPTION	QTY.
31015	Rigid top plate 1-1/2"	12 ea.
31020	Rigid top plate 2"	12 ea.
31025	Rigid top plate 2-1/2"	8 ea.
31030	Rigid top plate 3"	8 ea.
31040	Rigid top plate 4"	4 ea.
31050	Rigid top plate 5"	4 ea.
31060	Rigid top plate 6"	4 ea.
31080	Rigid top plate 8"	4 ea.
32015	Swivel wheel 1-1/2"	12 ea.
32020	Swivel wheel 2"	12 ea.
32025	Swivel wheel 2-1/2"	8 ea.
32030	Swivel wheel 3"	8 ea.
32040	Swivel wheel 4"	4 ea.
32050	Swivel wheel 5"	4 ea.
32060	Swivel wheel 6"	4 ea.
32080	Swivel wheel 8"	4 ea.
33015	Swivel with side locking brake 1-1/2"	12 ea.
33020	Swivel with side locking brake 2"	12 ea.
33025	Swivel with side locking brake 2-1/2"	8 ea.
33030	Swivel with side locking brake 3"	8 ea.
33040	Swivel with side locking brake 4"	4 ea.
33050	Swivel with side locking brake 5"	4 ea.



(Gondola not included)

PART#	DESCRIPTION	QTY.
33060	Swivel with side locking brake 6"	4 ea.
33080	Swivel with side locking brake 8"	4 ea.
31100	Pneumatic Caster Wheel fixed 10"	2 ea.
31101	Pneumatic Caster Wheel with swivel 10"	2 ea.
31102	Flat Free Caster Wheel fixed 10"	2 ea.
31103	Flat Free Caster Swivel wheel 10"	2 ea.
HB2035	Storage Bin	6 ea.
HB2045	Storage Bin	6 ea.
HB3045	Storage Bin	12 ea.

Small Wheel Rack Merchandiser

PART#	CONTENTS
80103	Freestanding Wheel Rack Only , 21"x 21"(footprint) x 72"(tall).
80103K	Full Wheel Rack Merchandiser. An assortment of pneumatic and flat free wheels on this space saving wheel rack. All metal with black enamel painted finish. 10 part #s, 20 pieces. Includes: 10" x 3" Dynaline "Replacement Wheels" decal and products listed below:

PART#	DESCRIPTION	QTY.
80103	Small Wheel Rack	1 ea.
80101	Pneumatic Wheel - 8.5"-2.50 R4	2 ea.
80102	Flat Free Wheel - 8.5"-2.50 R4	2 ea.
80105	Pneumatic Hand Truck Wheel, 10.18"	2 ea.
80107	Flat Free Hand Truck Wheel, 10.18"	2 ea.
80109	Pneumatic Outdoor Hand Truck Wheel, 10.08"	2 ea.
80111	Flat Free Outdoor Hand Truck Wheel, 10.23"	2 ea.
80113	Pneumatic H.D. Hand Truck Wheel, 12.25"	2 ea.
80115	Flat Free H.D. Hand Truck Wheel, 13"	2 ea.
80116	Pneumatic Wheel Barrow Wheel, 15.08"	2 ea.
80118	Flat Free Wheel Barrow Wheel, 15.3"	2 ea.



Caster & Assorted Wheels Merchandiser

PART#	CONTENTS
00302K	Full Caster & Assorted Wheels Plan-O-Gram . 24 part #s, 172 pieces. Includes header, and products listed below.

PART#	DESCRIPTION	QTY.
31015	Fixed Caster 1-1/2"	16
31020	Fixed Caster 2"	16
31025	Fixed Caster 2-1/2"	8
31030	Fixed Caster 3"	6
31040	Fixed Caster 4"	8
31050	Fixed Caster 5"	6
31060	Fixed Caster 6"	5
31080	Fixed Caster 8"	4
33015	Swivel Caster-Brake 1-1/2"	16
33020	Swivel Caster-Brake 2"	16
33025	Swivel Caster-Brake 2-1/2"	8
33030	Swivel Caster-Brake 3"	6
33040	Swivel Caster-Brake 4"	8
33050	Swivel Caster-Brake 5"	6
33060	Swivel Caster-Brake 6"	5
33080	Swivel Caster-Brake 8"	4
80116	Pneumatic Barrow Wheel 15"	2
80105	Pneumatic Hand Truck Wheel 10"	5
HB2045	Plastic Bin Blue	8
HB3045	Plastic Bin Blue	16



(Gondola not included)

PART#	DESCRIPTION	QTY.
80109	Pneumatic Hand Truck Wheel 10"	5
80101	Pneumatic Cart Wheel 8.5"	5
80118	Flat Free Barrow Wheel 15"	2
80107	Flat Free Hand Truck Wheel 10"	5
80111	Flat Free Hand Truck Wheel 10"	5
80102	Flat Free Cart Wheel 8.5"	5

HB2045



HB2035

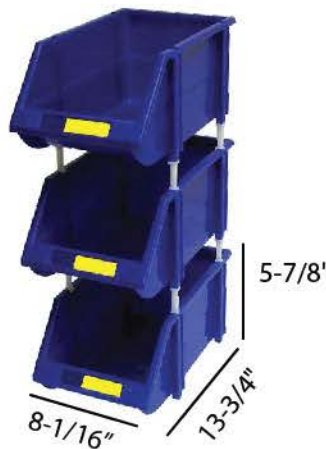

HB3045



! **PlanoGrams do not include gondola or shelves and may not be exactly as illustrated. *Retail hanging pegs not provided





Merchandisers



BOSS Padlock Merchandiser

PART#	CONTENTS	
00225	Padlock Display Board Only , 24" x 24"	
00225K	Full Padlock Merchandiser . 15 part #'s, 60 pieces. Includes 00225 display board, 16 pegs (80004), and the products listed below:	
PART#	DESCRIPTION	QTY.
2251525	Brass Padlock 25x14mm - KD	4 ea.
2251526	Brass Padlock 25x14mm - KA	4 ea.
2251530	Brass Padlock 30x20mm - KD	4 ea.
2251531	Brass Padlock 30x20mm - KA	4 ea.
2251540	Brass Padlock 40x23mm - KD	4 ea.
2251541	Brass Padlock 40x23mm - KA	4 ea.
2251550	Brass Padlock 50x30mm - KD	4 ea.
2251551	Brass Padlock 50x30mm - KA	4 ea.
2251560	Brass Padlock 60x33mm - KD	4 ea.
2251561	Brass Padlock 60x33mm - KA	4 ea.
2251740	Brass Padlock 40x63mm - KD	4 ea.
2251840	Brass Padlock 40x100mm - KD	4 ea.
2251850	Brass Padlock 50x75mm - KD	4 ea.
2253540	Waterproof Padlock 40mm - KD	4 ea.
2253541	Waterproof Padlock 40mm - KD	4 ea.
00225	Padlock Board Only	1 ea.

KD = Keyed different

KA = Keyed alike

BOSS Quality Cutters and Blades Merchandiser

PART#	CONTENTS	
77810	Cutter Display Board Only , 24" x 24"	
77810K	Full Cutter Merchandiser . 15 part #'s, 50 pieces. Includes 77810 display board, 19 pegs (80004) and the products listed below.	
PART#	DESCRIPTION	QTY.
2554403	Blade Heavy Duty 3/4"	6
2554404	Blade Single Edge	3
2554405	Blade Utility 2 notch	3
2554433	Blade Heavy Duty 3/4"	4
2555010	Samurai Blade Heavy Duty 3/4"	6
2555050	Samurai Blade Heavy Duty 3/4"	4
2560425	PKG - 3/4 Heavy Duty	2
2560430	6 Blade Auto Load 3/4"	3
2554033	PKG - Head Scraper	2
550460	PKG - Scraper with Blade	3
2568068	Carded Auto Lock Cutter	2
556750	PKG - 3/4 Heavy Duty	3
556900	Mega Cutter 1" Knob	3
568687	PKG - 3/4 Heavy Duty	3
568688	Ergo Grip Knob Lock Cutter	3
77810	Blades & Cutters Display Board	1
80004	Rod Rd - 1/4 x 6-1/2"	19



Drill Bit Display

PART#	CONTENTS
100811	Drill Bit Display Only. 27" x 18.5" x 17"
77890	Full Drill Bit Merchandiser. 24 part #'s, 144 pieces. Includes display, labels and products listed below:

PART NO.	DESCRIPTION	QUANTITY
851000	1/16" Grizzly Drill Bit 2/pack	6 ea.
851002	5/64" Grizzly Drill Bit 2/pack	6 ea.
851004	3/32" Grizzly Drill Bit 2/pack	6 ea.
851006	7/64" Grizzly Drill Bit 2/pack	6 ea.
851008	1/8" Grizzly Drill Bit 2/pack	6 ea.
851010	9/64" Grizzly Drill Bit	6 ea.
851012	5/32" Grizzly Drill Bit	6 ea.
851014	11/64" Grizzly Drill Bit	6 ea.
851016	3/16" Grizzly Drill Bit	6 ea.
851018	13/64" Grizzly Drill Bit	6 ea.
851020	7/32" Grizzly Drill Bit	6 ea.
851022	15/64" Grizzly Drill Bit	6 ea.
851024	1/4" Grizzly Drill Bit	6 ea.
851026	17/64" Grizzly Drill Bit	6 ea.
851028	9/32" Grizzly Drill Bit	6 ea.
851030	19/64" Grizzly Drill Bit	6 ea.
851032	5/16" Grizzly Drill Bit	6 ea.
851034	21/64" Grizzly Drill Bit	6 ea.
851036	11/32" Grizzly Drill Bit	6 ea.
851038	23/64" Grizzly Drill Bit	6 ea.
851040	3/8" Grizzly Drill Bit	6 ea.
851042	25/64" Grizzly Drill Bit	6 ea.
851044	13/32" Grizzly Drill Bit	6 ea.
851046	27/64" Grizzly Drill Bit	6 ea.
851048	7/16" Grizzly Drill Bit	6 ea.



Three-Blade Cutter Display

PART#	CONTENTS
100857	Display Only. 7.5" x 12" x 15.5"
558601	Three-Blade Cutter Display. Includes 3 types of blades.

PART NO.	DESCRIPTION	QUANTITY
2555010	Samurai Blade Heavy Duty 3/4" 10/ pkg	12
2555050	Samurai Blade Heavy Duty 3/4" 50/ pkg	12
2554303	Serrated Blade Heavy Duty 5/PKG	12



Merchandisers





Merchandisers



Counter-top BOSS Driver Bit Kit Display

- Gravity fed counter top point of purchase
- Compact design
- Contractor's choice
- Customizable kit tops

PART#	CONTENTS
100854	Driver Bit Kit Display Only. Includes decals. (Bit Kits sold separately).

MAX. BIT KITS	LENGTH	WIDTH	HEIGHT
13	7"	8"	15.5"

**THIS ITEM IS
CUSTOMIZABLE**



Does your business need more exposure? Product customization will help build your brand and boost your sales.

For more information on custom printing see Boss Tools & Accessories section or ask your local account manager.



Part# 721386



Part# 721374





Counter-top BOSS Compact Driver Bit Display

- #1 Acrylic Bit Display
- Magnetic 1/4" to 1/2"
- Robertson #1, #2, #3 from 2" to 6"
- Socket Adapters

PART#	CONTENTS
77799	Full Driver Bit Kit Merchandiser. Includes display, labels and 307 pieces. Size: 5" x 7" x 9"
100859	Driver Bit Kit Display Only. Includes decals.

PART NO.	DESCRIPTION	QUANTITY
72121	Robertson Bit - #1 x 2" Green	12
72122	Robertson Bit - #2 x 2" Red	36
72123	Robertson Bit - #3 x 2" Black	12
72131	Robertson Bit - #1 x 3" Green	12
72132	Robertson Bit - #2 x 3" Red	36
72133	Robertson Bit - #3 x 3" Black	12
72141	Robertson Bit - #1 x 4" Green	12
72142	Robertson Bit - #2 x 4" Red	36
72143	Robertson Bit - #3 x 4" Black	12
72151	Robertson Bit - #1 x 6" Green	12
72152	Robertson Bit - #2 x 6" Red	36
72153	Robertson Bit - #3 x 6" Black	12
73110	Magnetic Nut Driver 1/4" x 2.5 Yellow	12
73111	Magnetic Nut Driver 5/16"x 2.5 Green	9
73112	Magnetic Nut Driver 3/8" x 2.5 Red	12
73113	Magnetic Nut Driver 7/16"x 2.5 Brass	9
73114	Magnetic Nut Driver 1/2" x 2.5 Black	5
79150	Square Socket Holder 1/4" x 2" Long	5
79352	Square Socket Holder 3/8" x 2.56" Long	8
79353	Square Socket Holder 1/2" x 2.83" Long	6



Merchandisers

Boss Counter Top Merchandisers

1.877.453.3964

1.877.453.5050

www.dynaline.com

orders@dynaline.com

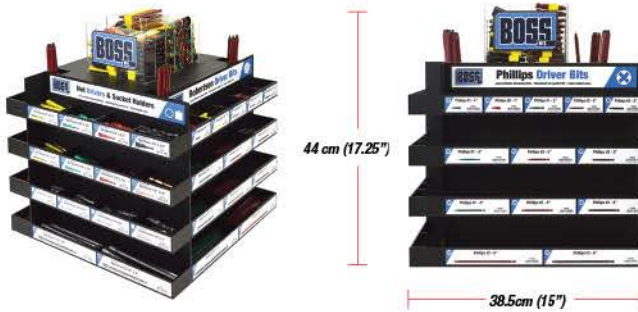

Large Rotating Driver Bit Merchandiser

PART#	CONTENTS
77808k	Large Rotating Driver Bit Display - Display and Products. 62 part #s, 585 pieces. Includes and the products listed below:
77808	Large Rotating Driver Bit Display - Display Only

PART NO.	DESCRIPTION	QUANTITY
72102	Robertson Bit - #1 x 1" Green	10
72120	Robertson Bit - #0 x 2" Yellow	10
72121	Robertson Bit - #1 x 2" Green	10
72122	Robertson Bit - #2 x 2" Red	15
72123	Robertson Bit - #3 x 2" Black	10
72131	Robertson Bit - #1 x 3" Green	10
72132	Robertson Bit - #2 x 3" Red	10
72133	Robertson Bit - #3 x 3" Black	10
72141	Robertson Bit - #1 x 4" Green	10
72142	Robertson Bit - #2 x 4" Red	10
72143	Robertson Bit - #3 x 4" Black	10
72151	Robertson Bit - #1 x 6" Green	10
72152	Robertson Bit - #2 x 6" Red	10
72182	Robertson Bit - #2 X 12" Red	20
72201	Phillips #1 x 1" Green	15
72202	Phillips #2 x 1" Red	15
72221	Phillips #1 x 2" Green	10
72222	Phillips #2 x 2" Red	15
72223	Phillips #3 x 2" Black	10
72231	Phillips #1 x 3" Green	10
72232	Phillips #2 x 3" Red	15
72233	Phillips #3 x 3" Black	10
72241	Phillips #1 x 4" Green	10
72242	Phillips #2 x 4" Red	15
72243	Phillips #3 x 4" Black	10
72252	Phillips #2 x 6" Red	10
72253	Phillips #3 x 6" Black	10
73110	Magnetic Nut Driver 1/4" x 2.5 Yellow	10
73111	Magnetic Nut Driver 5/16"x 2.5 Green	5
73114	Magnetic Nut Driver 1/2" x 2.5 Black	5
73210	Deep Hole Nut Driver 1/4"x 2.5 Yellow	10
73211	Deep Hole Nut Driver 5/16"x2.5 Green	5
73212	Deep Hole Nut Driver 3/8"x2.5 Red	5
73213	Deep Hole Nut Driver 7/16"x2.5 Brass	5
73112	Magnetic Nut Driver 3/8" x 2.5 Red	5
75121	Square Impact Round Body #1 x 2" Green-Magnetic	10

PART NO.	DESCRIPTION	QUANTITY
75122	Square Impact Round Body #2 x 2" Red -Magnetic	10
75123	Square Impact Round Body #3 x 2" Black-Magnetic	10
75132	Square Impact Round Body #2 x 3" Red -Magnetic	10
75133	Square Impact Round Body #3 x 3" Black-Magnetic	10
75142	Square Impact Round Body #2 x 4" Red-Magnetic	10
75152	Square Impact Round Body #2 x 6" Red-Magnetic	10
78421	Torque T15 x 2"	10
78422	Torque T20 x 2"	10
78423	Torque T25 x 2"	10
78424	Torque T30 x 2"	10
78425	Torque T40 x 2"	10
78450	Tamper Proof Torque T10x2"	10
78451	Tamper Proof Torque T15x2"	10
78452	Tamper Proof Torque T20x2"	10
78453	Tamper Proof Torque T25x2"	10
78454	Tamper Proof Torque T27x2"	10
79150	Square Socket Holder 1/4" x 2"	10
79310	Magnetic Nut Driver 1/4" x 6"	5
79311	Magnetic Nut Driver 5/16" x 6"	5
79352	Square Socket Holder 3/8" x 2.56"	5
79353	Square Socket Holder 1/2" x 2.83"	5
79560	Square Socket Holder 3/8" x 2.4"	5
711221	Robertson Driver Bits Sq #2 x 2" - 10 Pack	5
711276	Assorted Robertson & Phillips Driver Bits Colored - 10 Pack	5
717186	Magnetic Nut Driver Bit Colored- 5 pk 73110,111,112,113,114	5
777586	Metric Magnetic Nut Driver 79708, 709, 710, 712, 715 - 5 Pack	5

Merchandisers



Small Rotating Driver Bit Merchandiser

PART#	CONTENTS
77806	Small Rotatng Driver Bit Display - Display Only
77806K	Small Rotatng Driver Bit Display - Display and Products. 46 part #s, 235 pieces. Includes and the products listed below:

PART NO.	DESCRIPTION	QUANTITY
717186	Magnetic Nut Driver Bit	5
72101	Sq#1 x 1" 2pc Green	5
72102	Sq#2 x 1" 2pc Red	5
72103	Sq#3 x 1" 2pc Black	5
72121	Sq#1 x 2" 2pc Green	5
72122	Sq#2 x 2" 2pc Red	10
72123	Sq#3 x 2" 2pc Black	5
72131	Sq#1 x 3" 2pc Green	5
72132	Sq#2 x 3" 2pc Red	5
72133	Sq#3 x 3" 2pc Black	5
72151	Sq#1 x 6" 2pc Green	5
72152	Sq#2 x 6" 2pc Red	5
72153	Sq#3 x 6" 2pc Black	5
72201	Phillips #1 x 1" Green	5
72202	Phillips #2 x 1" Red	5
72203	Phillips #3 x 1" Black	5
72221	Phillips #1 x 2" Green	5
72222	Phillips #2 x 2" Red	5
72223	Phillips #3 x 2" Black	5
72231	Phillips #1 x 3" Green	5
72232	Phillips #2 x 3" Red	5
72233	Phillips #3 x 3" Black	5
72251	Ph#1 x 6" Green	5
72252	Phillips #2 x 6" Red	5
72253	Ph#3 x 6" Black	5
75121	Impact Round Body #1 x 2" Green	5
75122	Impact Round Body #2 x 2" Red	5
75123	Impact Round Body #3 x 2" Black	5
75131	Impact Round Body #1 x 3" Green	5
75132	Impact Round Body #2 x 3" Red	5
75133	Impact Round Body #3 x 3" Black	5
75151	Impact Round Body #1 x 6" Green	5
75152	Impact Round Body #2 x 6" Red	5
75153	Impact Round Body #3 x 6" Black	5
78101	S2 Sq #1 x 1"	1
78102	S2 Sq#2 x 1"	5
78103	S2 Sq#3 X 1"	5
78121	S2 Sq#1 x 2"	5

PART NO.	DESCRIPTION	QUANTITY
78122	Sq# 2 x 2" Plain Finish	5
78123	S2 Sq# 3 x 2"	5
78131	S2 Sq#1 x 3"	5
78132	S2 Sq#2 x 3"	5
78133	S2 Sq#3 x 3"	5
78151	S2 Sq#1 x 6"	5
78152	S2 Sq#2 x 6"	5
78153	S2 Sq#3 x 6"	5

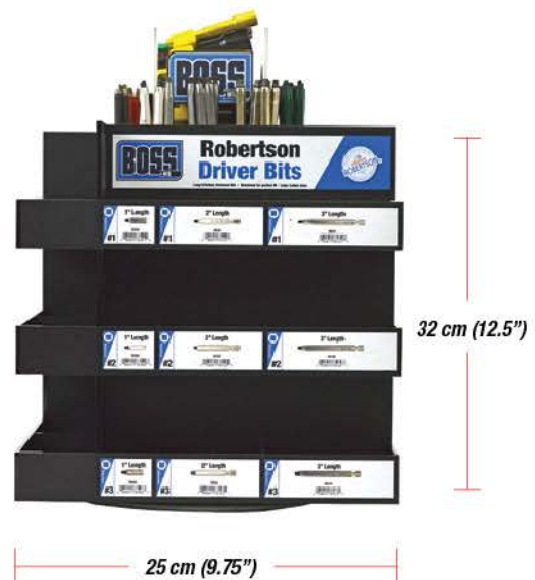
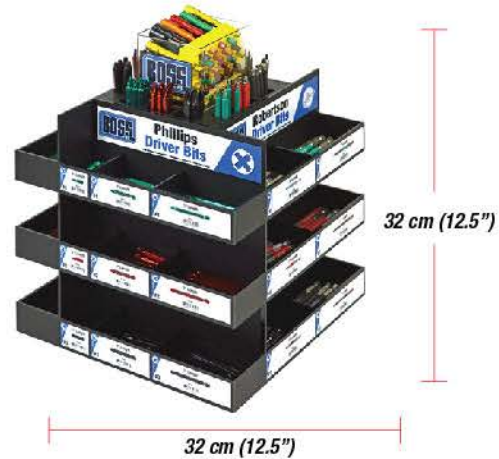

Dynaline Custom Signs

PART#	CONTENTS
-------	----------

Call us! Custom Print Mounted on Corrugated Plastic material - up to 4' tall



Universal Display Boards

Create your own product selection. Simply position and drill the holes you need. Order 80004 pegs as required (sold separately). Two sizes available.

PART#	DESCRIPTION
00800	12" x 24"
00801	24" x 24"

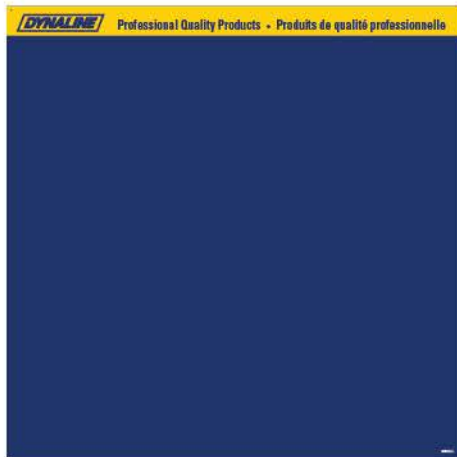

Get a Custom Banner fit to your specific needs!

PART#	CONTENTS
-------	----------

Call us! Custom Print on Banner Material - up to 8' long and 4' high



Merchandisers



Custom Bulk Bin Merchandising!

Dynaline strives to provide our customers with all the tools they need to be successful. Our custom bulk bin merchandising program allows you to customize the products specific to your local market. With your cooperation, our account managers will sit down with you and quickly determine what products and categories are the most popular in your business and can provide a merchandiser featuring all the fastest moving products in one simple display. Contact your local account manager for more information on this valuable program.

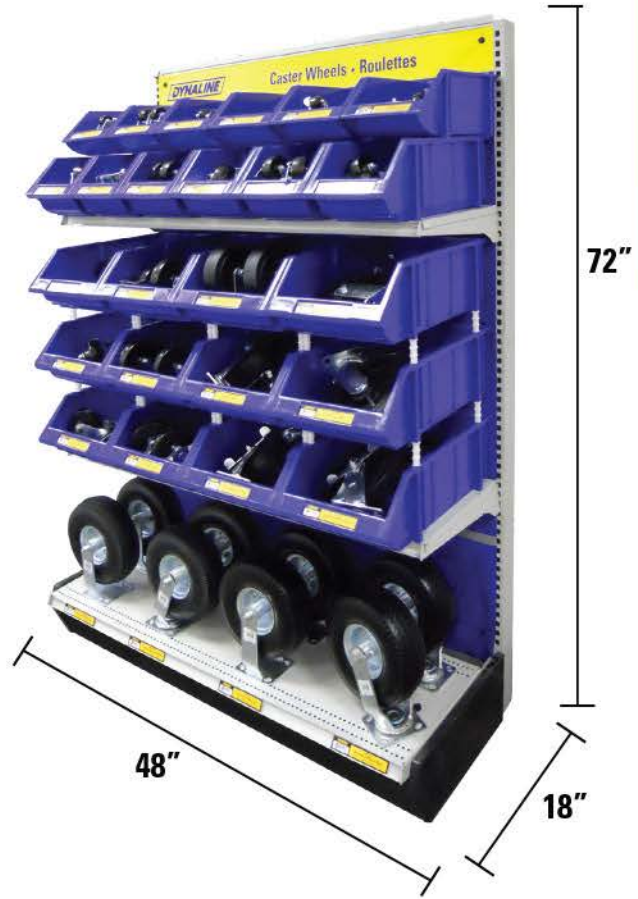

Merchandisers

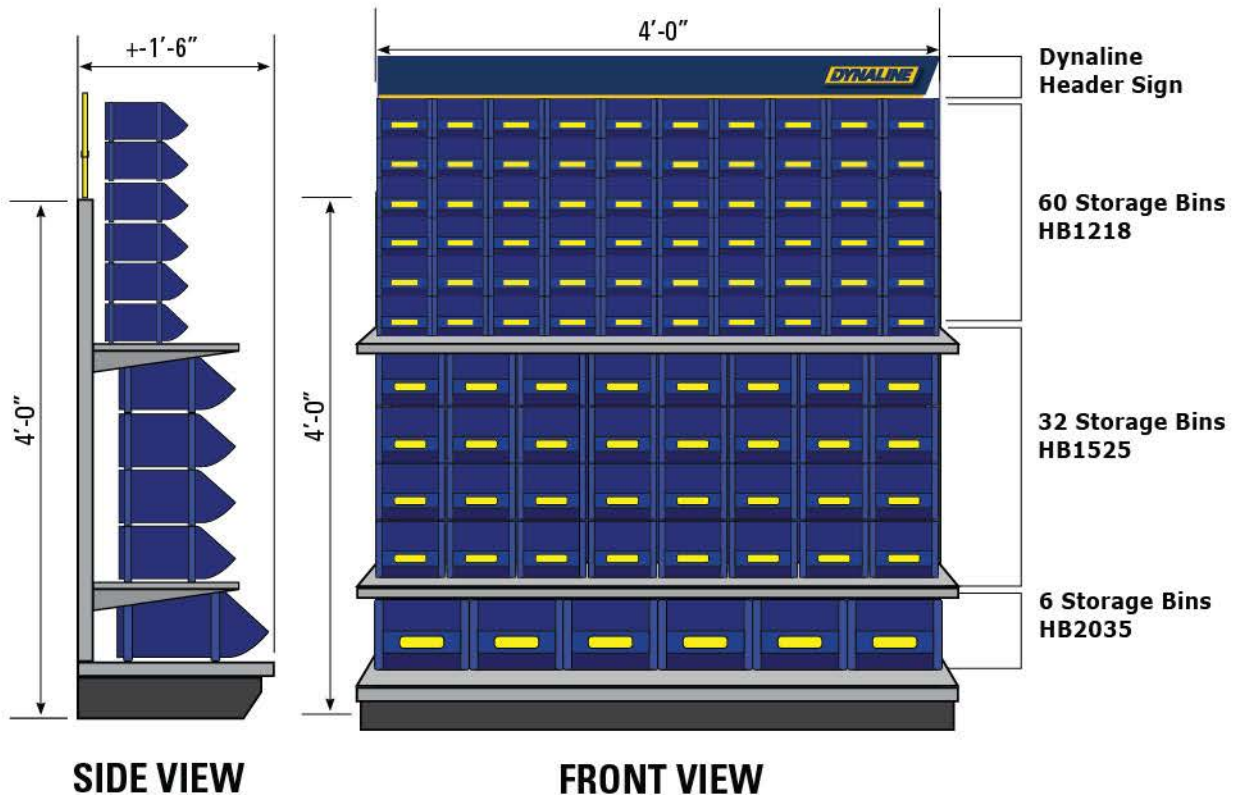

Custom Bulk Bin Features



Merchandisers



Once a product category or layout is determined, Dynaline will assemble your custom merchandiser and determine how many products it will need. We offer multiple bin sizes to ensure all your product will fit and look presentable to your valued customers.

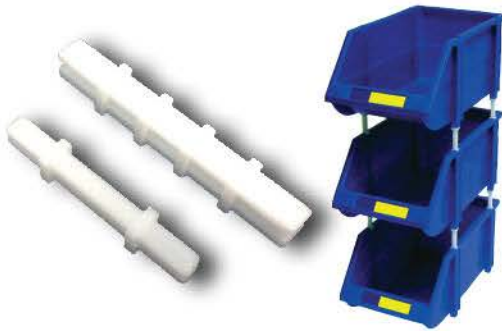

We will ship all the bins you need including riser pins so your customers have easy access to your products. All bin sizes have corresponding risers so you aren't limited in your selection.



Dynaline will print out any labels you need for your custom merchandiser. We will also print merchandiser headers for your display giving your customers confidence that the products you offer are provided by the trusted Dynaline brand.



Storage Bins

Durable, open, stackable design as well as side by side. Supplied with stacking pegs and labels.

PART#	LENGTH	WIDTH	HEIGHT	WEIGHT CAP.	CARTON QTY.
HB1218	7-1/16"	4-3/4"	3-5/16"	3 kg	60
HB1525	10"	5-7/8"	4-3/4"	6 kg	36
HB2035	13-3/4"	8-1/16"	5-7/8"	20 kg	16
HB2045	18-7/8"	7-7/8"	7"	30 kg	12
HB3045	18-7/8"	11-3/4"	7"	50 kg	12



Tilt Bins

- Easy multi-purpose storage solution.
- Functional design allows them to be stacked, screwed to a wall, or attached to a display unit.
- Sections interlock to form a rigid storage solution.
- Supplied with fastening screws and pegs.



PART#	DESCRIPTION			
TF306	6 Compartments Tilt Bin (3 wide & 2 high)			
	Width	Depth	Height	Weight Cap.
	11-13/16"	3-5/8"	9"	15 kg
TF308	8 Compartments Tilt Bin (4 wide & 2 high)			
	Width	Depth	Height	Weight Cap.
	11-13/16"	2-1/2"	6-5/8"	15 kg
TF604	4 Compartments Tilt Bin (4 wide)			
	Width	Depth	Height	Weight Cap.
	23-5/8"	6-5/8"	8-3/16"	30 kg
TF605	5 Compartments Tilt Bin (5 wide)			
	Width	Depth	Height	Weight Cap.
	23-5/8"	5-1/4"	6-1/2"	20 kg

Dynaline Bin Box

PART#	DESCRIPTION
00007	A great way to organize small parts. Corrugated cardboard box with dividers. Dimensions: 11-11/16"L x 4-7/8"W x 3-13/16"H



Interlocking Bins

Exclusively designed by Dynaline our Interlocking Bin System provides the right retail solution.

Can be used on any standard gondola shelves!



Merchandisers

- Durable, flexible, long-lasting material, easy to assemble.
- Four spacing sizes of bins available (4", 6", 8" and 12") x 12" deep.
- Sloped design clearly displays product.
- Bottomless design makes this system cost-effective.



* System allows a range of combined built options.



* Unique front design accomodates large labels.



* Special tab design will allow push pins to hold bins in place.



Interlocking Bin Components

PART#	DESCRIPTION
01903	Side Wall - 12"L x 6"H
01904	Front/Back Wall - 4"L x 3"H
01905	Front/Back Wall - 6"L x 3"H
01906	Front/Back Wall - 8"L x 3"H
01907	Front/Back Wall - 12"L x 3"H
01908	Push Pin for Interlock Bins. 14mm Head Diameter.



01907 01906 01905 01904



01903



01908 - push pins





IMPULSE BUY PRODUCTS

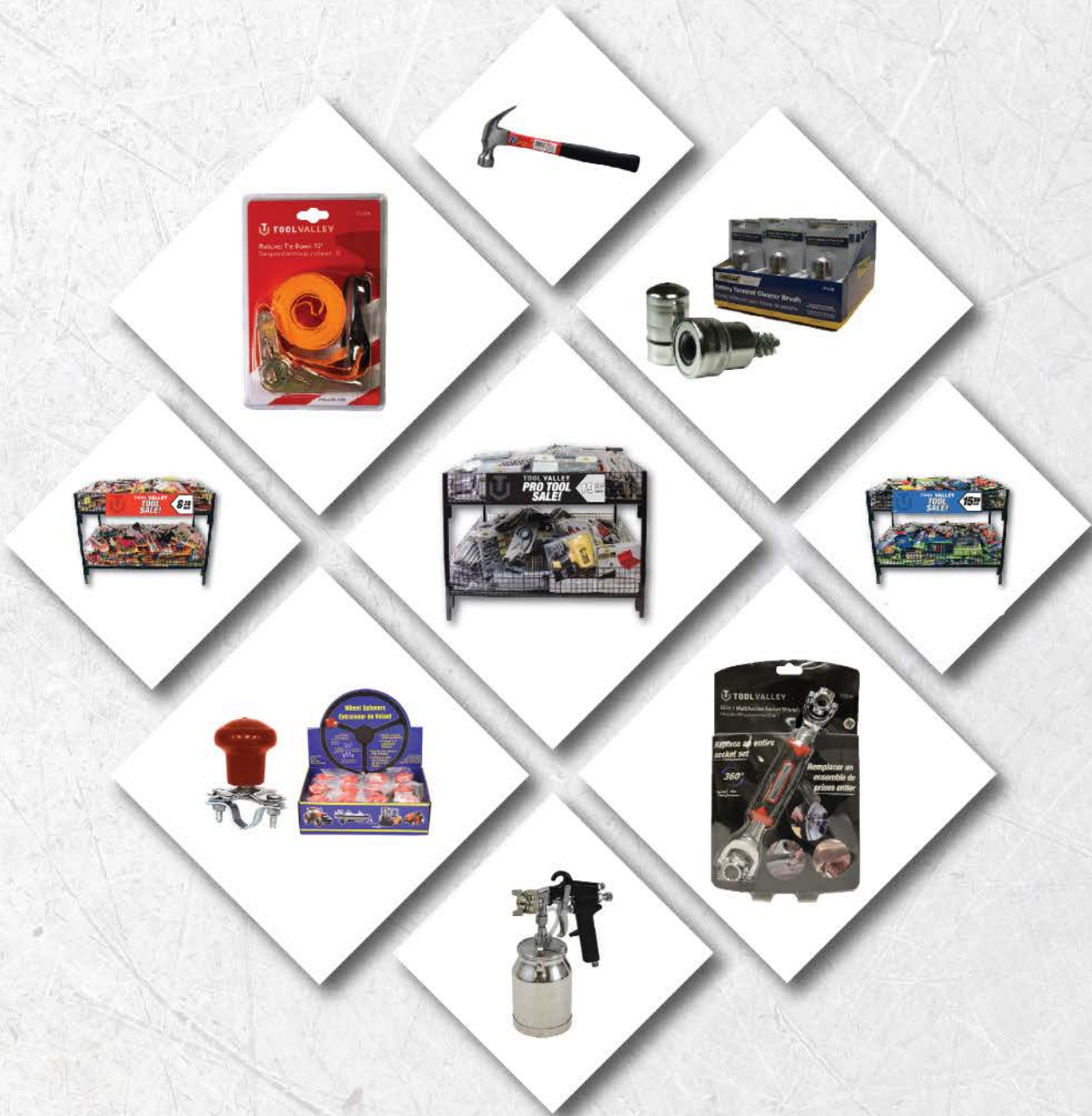



A		Cushion Grip Screwdriver Set	94
AC / DC Multi Tester	92	D	
AC/DC Multi Tester	89	Dead Blow Hammer	92
Adapter and U-Joint Set	98	Diagonal Plier	85
Adapter and U-Joint Set	99	Dr S.A.E. Hex Bit Socket	101
Adjustable Hacksaw	83	Dr. Breaker Bar	101
Adjustable Wrench	91	Dr. Metric Hex Bits	102
Adjustable Wrench	84	Dr. Offset Ratchet	101
Air Blow Gun	88	Drill Brushes Set	96
Air Tool Coupler Set	84	Drill Eraser	96
Artist Brush	83	Drive Extension Set	86
Assorted Electrical Terminals	85	Drive Extension Set	88
Assortment - Automotive Fuse	93	Drive Offset Ratchet	100
Assortment - Master Auto Fuse	98	Driver Socket Set 10 pcs	91
Assortment - Metric O-Ring	100	Drum Bung Adapter	80
Assortment - Mini Car Fuse	93	Dust Mask Set	87
Assortment - O-Ring	86	Dust Mask Set	95
Assortment - S.A.E. O-Ring	99	E	
Assortment - Twine	89	Ear Muffs and Safety Glasses	94
Automotive Fuse Set	84	Easy Out and Drill Bit Set	94
B		Elastic Cord with Hook	88
Ball Hex and Star Driver Set	93	Extended Scraper	89
Battery Terminal Cleaner Brush	80	Extension Bar Set	95
Big Handle Screwdriver Set	89	Extra Long Needle Nose Pliers	93
Bit Holder and Extension Set	95	Extra Long Ratchet	99
Black Table	97	Extra Long Screwdriver Set	88
Blue Table	90	Extra Long Socket Adapter	86
Bolt Cutter	101	F	
Booster Cables	96	Fencing Plier	103
Brick Bolster Cold	102	Fiber glass Sledge Hammer	91
Brush - 4-in-1	87	File Set with Handles	84
Brush Set	85	Flat Edge Cold Chisel	102
Brush Set	95	Flex Scraper Set	87
C		Folding Utility Knife	93
Cable Tie Set	92	Folding Utility Knife	100
Cable Ties Set	85	Framing Hammer	91
CamBuckle Set	92	G	
Claw Hammer	87	Grab-it-Gadget	92
Claw Hammer	94	Grease Hose	81
Close Quarter Hacksaw	85	Groove Joint Plier	84
Composite Digital Caliper	100	Groove Joint Pliers	92
Compound Action Cable Cutters	100	Groove Joint Pliers	102
Contractor's Screwdriver Set	94	H	
Crimper	103	Hacksaw Blade Set	88
Crimping Tool and Terminal Kit	93	Hammock	103
Crimping Tool with Terminals	84	Hand Saw	86
Cross Pein Hammer	98	Heat Shrink Tube Kit	100



Heavy Duty Hacksaw	92	Micro Precision Bit Set - 30-in-1	93
Heavy Duty Long Stretch Cord	92	Micro-driver Bit Set	88
Heavy Duty Magnifying Glass	85	Mini Auto Fuse Set	86
Heavy Duty Tire Repair Kit	94	Mini Pistol Grease Gun Kit	102
Heavy Duty Voltage Tester	94	Mini Plier Set	91
High Speed Drill Bit Set	94	Mini Precision Plier Set	101
High Torque Ratcheting Dr	102	Mini Screwdrivers set	86
Hobby Knife Set	83	Mirror and Magnet Set	91
Hole Saw Set	84	Mounted Stone Set	86
Hollow Punch Set	94	Multi Purpose Shear Set	85
HPLV Spray Gun	81	Multi Use Power Bit Set	100
I		Multifunction Socket Wrench	102
Impact Reducer Adapter Set	100	Multi-Purpose Lithium Grease	80
Inspection Mirror	88	Multipurpose Razor Scraper Set	99
Internal Pipe Wrench Set	101	N	
Iron Padlock	94	Needle Nose Pliers	84
L		Nylon Scraper Set	101
L.E.D. Head Lamp	87	O	
Linesman Pliers	84	Offset Micro Bit Driver	99
Locking Pliers	84	Oil Filter Pliers	103
Log Splitter Drill Bit	89	O-Ring Set	93
Long Blade Aviation Tin Snip	95	Outlet Power Strip	94
Long Needle Nose Pliers	88	P	
Long Power Bit Set	93	Paint Brush	83
Lug Wrench 14" Long S.A.E. - 4 Way	95	Paint Brush Set	95
M		Parts Cleaning Brush Set	85
Magnetic Nut Driver Set	87	Pick-up Tool Set	83
Magnetic Parts Dish	87	Plastic Cutters	79
Magnetic T-Bar Driver	83	Plastic-Rubber Mallet	87
Measuring Reel	103	Plier Set	88
Measuring Tape	83	Plier Set	91
Measuring Tapes	79	Plier Set	98
Measuring Tapes	80	Power Bit Set	85
Mechanics Gloves	93	Power Grip Vacuum Cup	88
Mechanics Pick and Hook Set	85	Power Nut driver and Bit Set	87
Mechanics Pick Hook and Driver Set	93	Precision Screwdriver Set	83
Metric Combination Wrench Set	84	Pry Bar Set	98
Metric Combo Wrench	102	Pry Bar Set	102
Metric Deep Socket Drive Set	91	Punch and Chisel Set	91
Metric Drive Hex Bit Socket	94	PVC Air Hose	99
Metric Grease Fit Assort	101	PVC Pipe Cutter	91
Metric NonSlip Hex Key Set	100	R	
Metric Nut Driver Set	84	Ratchet Driver	83
Metric Socket Set with Rail	89	Ratchet Tie Down	86
Metric Stubby Wrench Set	101	Ratchet Tie Down	91
Metric Tap Set	95	Ratchet Tie Down Set	92
Micro Fuse Set	94	Ratchet with 6 S.A.E. Sockets	86





Ratcheting Wire Terminal Crimper	99	Step Bit	96
Read Easy S.A.E. Tape Measure	92	Storage Straps	96
Receptacle Tester	88	Straight Aviation Snip Tool	85
Red Table	82	T	
Rubber Mallet	87	Tamper Proof Star Bit Set	86
Rubber Mallet	95	Tamper Proof Star Key Set	88
Rubber Tie Down Strap Set	92	Tamper Proof Star Socket Set	92
S		Telescoping Magnet	88
S.A.E Hex Key Set	83	Tire Inflator and Dial Gauge	98
S.A.E. Ball Hex Key Set	92	Tire Repair Kit	86
S.A.E. Combination Wrench	93	Titanium Drill Bit Set	98
S.A.E. Combination Wrench Set	84	Tool Bag	86
S.A.E. Combo Wrench Set	101	Tow Rope	92
S.A.E. Deep Socket Drive	91	Tri-Tap Extension Cord	95
S.A.E. Drill Bit Set	85	Tubing Bender - 180°	99
S.A.E. Drive Hex Bit Socket	94	Tubing Cutter	83
S.A.E. Hollow Shaft Nut Driver	92	Tweezer Set	89
S.A.E. Non Slip Hex Key Set	102	U	
S.A.E. Nut Driver Set	84	Ultimate Grab-it Gadget	102
S.A.E. Socket Set with Rai	89	Utility Bar	87
S.A.E. Stubby Wrench	100	Utility Bar Tool	95
S.A.E. Tape Measure Set	99	Utility knife with self-feeding	87
Safety Vest	89	Utility Pick-up Tool Set	99
Scraper Set	102	V	
Screw Extractor	100	Volt Circuit Tester	85
Screwdriver Bit Set	93	W	
Screwdriver Bit Set	99	Wire Brush	83
Screwdriver Kit	95	Wire Brush Set	94
Screwdriver Set	99	Wire Wheel Set	86
Screwdriver Set 8	91		
Screwdriver Set with Rack	85		
Seal & O-Ring Remover Set	101		
Security Bit Set	101		
Self Adjusting Wire Stripper	98		
Self-Priming drill pump	83		
Shock Cord Set	85		
Shop Towels	81		
Sink and Drain Cleaner	88		
Slip Joint Pliers	84		
Snap Ring Plier Set	93		
Socket Adapter Set	86		
Socket Set	98		
Stainless Steel Rulers - 3 Pieces	96		
Standard Carpenter Pencils	79		
Stapler	96		
Star Socket Bit Set	100		
Steering Wheel Spinners	81		



Standard Carpenter Pencils

PART#	COLOUR	LEAD	BOX/CASE
33810	Yellow	Medium	60 /1200
33820	Red	Medium	60 /1200
33830	Blue	Medium	60 /1200
33840	Orange	Medium	60 /1200
33850	White	Medium	60 /1200
33860	Dark Blue	Medium	60 /1200
33870	Black	Medium	60 /1200
33800	Green	Medium	60 /1200



Plastic Cutter, 3/4" Blade

PART#	COLOUR	SHEATH/LOCK	BLADE GRADE	BOX/ CASE
2558228	Red	Plastic / Thumb	Regular	48 / 480
2558229	Dark Green	Plastic / Thumb	Regular	48 / 480
2558230	Blue	Plastic / Thumb	Regular	48 / 480
2558231	Yellow	Plastic / Thumb	Regular	48 / 480
2558232	Orange	Plastic / Thumb	Regular	48 / 480
2558233	Light Green	Plastic / Thumb	Regular	48 / 480
2558234	Black	Plastic / Thumb	Regular	48 / 480



Heavy Duty Plastic Cutter, 3/4" Blade

PART#	COLOUR	SHEATH/ LOCK	BLADE GRADE	BOX/ CASE
2558066	Red	Plastic / Thumb	Regular	24 / 240
2558067	Blue	Plastic / Thumb	Regular	24 / 240
2558068	Yellow	Plastic / Thumb	Regular	24 / 240



Utility Grade - 6/Box

PART#	LENGTH	GRADUATION	WIDTH	HOOK
38220	25'	Imperial	1"	Standard
38120	16'	Imperial/Metric	1"	Standard



Professional Grade - 12/Box

PART#	LENGTH	GRADUATION	WIDTH	HOOK
38316	16'/5m	Imperial/Metric	1"	Standard
38325	25'/7.5m	Imperial/Metric	1"	Standard
38425	25'	Imperial	1"	Standard
38475	25'	Imperial/Double Sided	1"	Magnetic*
38450	25'/7.5m	Imperial	1-1/4"	Standard



38480

38316

Extra Long - 12/Box

PART#	LENGTH	GRADUATION	WIDTH	HOOK
38480	33'	Imperial/Metric	1"	Double Magnet



38120



Impulse Buy Products





Extra Long Measuring Tapes

PART#	LENGTH	GRADUATION	WIDTH	HOOK	PER BOX
38525	6'	Imperial/Metric	1"	Double Magnet	12
38550	25'	Imperial/Metric	1"	Double Magnet	6



Drum Bung Adapter

PART#	DESCRIPTION	DISPLAY BOX QTY
11074	Fits 2" NPT North American drums. Durable neoprene seal. 3/4" opening. Made from durable PP plastic.	12



11073

Multi-Purpose Lithium Grease

An excellent multi-purpose extreme pressure grease for ball joints, steering knuckles, chassis, etc. Very good sealing properties to keep water & dirt out. (Formula EP-2)



11070

PART#	FEATURES	DISPLAY BOX
11073	3 oz. (85g) grease tubes. Clamshell package - 3 pcs	6
11070	14 oz. (400g) grease tube	10

Battery Terminal Cleaner Brush



PART#	DESCRIPTION	DISPLAY BOX QTY
11128	<ul style="list-style-type: none"> Internal and external wire brushes built into the rugged steel case External brush for cleaning cable clamps, internal brush for posts 	18



Steering Wheel Spinners

Vinyl coated aluminum knob with chrome plated base. Ball bearing insert for long life. Safe and easy for use with most off-road vehicles.

Not for highway use.

PART#	COLOUR	QUANTITY
28327	Red	12 pieces per display box
28329	Black	12 pieces per display box



Grease Hose - Steel wire (in display box)

Reinforced rubber cover with steel wire braid. Working temperature: -40° to 95°C. Each grease hose is individually UPC barcode labeled inside a full colour display box.

PART#	LENGTH	ENDS	SAFE WORKING PRESSURE	WORKING TEMPERATURE	PACKAGE TYPE
11142	12"	1/8" NPT	3,600 PSI	-40°C to 95°C	10/ Package
11143	18"	1/8" NPT	3,600 PSI	-40°C to 95°C	10/ Package



HPLV Spray Gun (High Pressure Low Volume)

PART#	AIR PRESSURE	AIR CONSUMPTION	SPRAY HEAD AND NEEDLE	CUP CAPACITY	AIR INLET
19418	50 - 60 PSI	5 - 10 CFM	1.8mm	1000ml	1/4"



Shop Towels

PART#	COLOR	PIECES PER BUNDLE
51395	Red	6 pieces



Impulse Buy Products



TOOL VALLEY

Impulse Buy Red Table Products

- The Tool Valley **Red** Impulse Buy Table is the perfect way to drive sales of those last minute purchases by your customers.
- The products in the red table are all sold at a low \$8.28 price point.
- Our No-risk Guarantee ensures that the products that don't sell can be returned and replaced with faster moving products at no charge.
- Contact your Account Manager or Dynaline customer service for more information on the Impulse Buy Tables.

Impulse Buy Products



COMPACT TABLE

36" x 36"



PART#	CONTENTS
RED-TABLE	Red Table Merchandiser - 89 part #s, 206 pieces.
WRD-3030	36" x 36" Double Wire Table Display Only (Includes 4 Casters)
51078-09	Red Table Sign Only (Bilingual)

ZERO RISK!

Stock Protection Guarantee for 2 years!
If it doesn't sell, we will take it back without penalty!





51101 - S.A.E Hex Key Set, 10 pc

Sizes: 1/16", 5/64", 3/32", 1/8", 5/32", 3/16", 7/32", 1/4", 5/16", 3/8".



51102 - Metric Hex Key Set, 9 pcs

Sizes: 1.5, 2, 2.5, 3, 4, 5, 6, 8, 10 mm.



51103 - Hobby Knife Set, 16 pcs

Includes: 3 knives, 13 assorted blades, 1 storage case.



51108 - Adjustable Hacksaw, 12"



51111 - Measuring Tape, 16' x 3/4" S.A.E./Metric



51112 - Artist Brush, 15 pcs set



51113 - Paint Brush, 5 pcs set

Sizes: 1", 1-1/2", 2", 2-1/2", 3".



51114 - Wire Brush, 2 pcs set



51116 - Self-Priming drill pump - 1/4" shanks.



51127 - 3/8" Ratchet Driver
8" handle



51130 - Magnetic T-Bar Driver, 25 pcs
Includes 9 sockets, 11 bits, T-bar & bit adapter, & 2 rubber holders



51131 - Precision Screwdriver Set, 12 pcs
Includes 6 slot bits, 3 Phillips, 2 hex & 1 crossbar



51140 - Tubing Cutter, Large
Cuts 1/8"-1-1/8" copper, aluminum & other thin wall tubing



51141 - Pick-up Tool Set, 2 pcs
Includes: 24" four-finger, 24" magnetic





Impulse Buy Products



51142 - Hole Saw Set, 5pcs
 Sizes: 1-1/4", 1-1/2", 1-3/4", 2-1/8".
 Includes a Mandrel.



51150 - 8-1/2" Crimping Tool with Terminals



51157 - S.A.E. Nut Driver Set, 4 pcs
 Sizes: 1/4", 5/16", 3/8", 7/16"



51158 - Metric Nut Driver Set, 4 pcs
 Sizes: 6mm, 7mm, 8mm, 10mm.



51159 - Locking Pliers, 7"



51160 - Groove Joint Plier 8"



51161 - Adjustable Wrench 8"



51162 - Linesman Pliers / Cutter 7"



51163 - Needle Nose Pliers 8"



51164 - Slip Joint Pliers 8"



51165 - S.A.E. Combination Wrench Set, 4 pcs
 Sizes: 3/8", 7/16", 1/2", 9/16"



51166 - Metric Combination Wrench Set 4 pcs
 Sizes: 10mm, 11mm, 13mm, 14mm



51170 - Air Tool Coupler Set 4 pcs



51171 - Automotive Fuse Set 25 pcs
 Contains 4 each of 5A, 10A, 15A, 20A, 25A, 30A.
 Includes a fuse puller



51177 - 6" File Set with Handles 6 pcs
 7" long file with plastic handle





51178 - Brush Set 3 pcs
 A steel, brass and plastic



51182 - Mechanics Pick and Hook Set 4 pcs
 Set includes straight, curved, offset and 90 degree



51184 - Shock Cord Set 8 pcs
 Includes 4 pieces 18", 2 pieces 24", 2 pieces 36"



51185 - Screwdriver Set with Rack, 6 pcs
 Slot: 3/16"x3", 1/4"x4", 1/4"x6"; Phillips: #1x3", #2x4", #2x6"



51202 - 6" Diagonal Plier



51241 - Volt Circuit Tester 6V / 12V



51244 - Multi Purpose Shear Set 2 pcs



51245 - Close Quarter Hacksaw
 Includes 10" hacksaw blade, but can also accept 12" size blades



51252 - Straight Aviation Snip Tool 10"



51262 - S.A.E. Drill Bit Set 13 pcs
 Sizes: 1/16", 5/64", 3/32", 7/64", 1/8", 9/64", 5/32", 11/64", 3/16", 13/64", 7/32", 15/64", 1/4"



51265 - Heavy Duty Magnifying Glass



51282 - Cable Ties Set 150 pcs
 4"-70 pcs, 6"-50 pcs and 8"-30 pcs



51275 - Parts Cleaning Brush Set 5 pcs
 1 parts cleaning brush, 1 fingernail brush, 3 mini brushes



51277 - Power Bit Set 33 pcs
 Includes Phillips, slotted, star, square, hex and magnetic bit holder



51285 - Assorted Electrical Terminals 60 pcs

Impulse Buy Products

Red Impulse Buy Products

1.877.453.3964

1.877.453.5050

www.dynaline.com

orders@dynaline.com

Impulse Buy Products



51283 - Mini Screwdrivers set 8 pc
Includes one each: T-10 & T-15 star, 3/16" & 1/4" slot, #1 & #2 Phillips, S1 & S2 Square



51284 - Tamper Proof Star Bit Set 13 pcs
Includes 6 star bits, 7 tamper proof star bits



51292 - O-Ring Assortment 50 pcs
12 assorted popular sizes



51290 - Ratchet with 6 S.A.E. Sockets 1/4" Drive
Contains 1/4" DR. Shallow sockets: 3/16", 1/4", 5/16", 3/8", 7/16", 1/2". 3" extension bar, a speed disk & 1/4" ratchet



51291 - Extra Long Socket Adapter 3 pcs
Sizes: 1/4" Dr. x 2-1/2"; 3/8" Dr. x 2-1/2"; 1/2" Dr. x 3"



51299 - 15' Ratchet Tie Down
with vinyl coated S hooks



51295 - 3/8" Drive Extension Set 2 pcs



51296 - Tire Repair Kit



51301 - Hand Saw 14"



51303 - 11" Tool Bag with 16 Pockets



51309 - Mounted Stone Set 12 pcs



51317 - Mini Auto Fuse Set 32 pcs
Contains four each of 2A, 5A, 7.5A, 10A, 15A, 20A, 25A, 30A
Sizes: 3" and 6"



51318 - Wire Wheel Set, 4 pcs
Includes 2" flat, 3" flat, 4" flat, 2" cup. All with 1/4" shafts



51327 - Socket Adapter Set 4 pcs
Contains 3/8" F x 1/4" M reducer; 1/2" F x 3/8" M reducer; 1/4" F x 3/8" M adapter; 3/8" F x 1/2" M adapter





51328 - Flex Scraper Set 3 pcs
 Sizes 1', 2', 3'



51331 - Utility Bar 15"



51334 - 4-in-1 Brush
 - 1/2 & 3/4 I.D. fitting brushes
 - 5/8 & 7/8 O.D. tube cleaning brushes



51338 - Power Nut driver and Bit Set,
13 pcs
 Includes 8 power nut drivers (SAE), 2 Phillips bits, 2 slot bits, 1 magnetise bit holder



51339 - Dust Mask Set 20 pcs



51340 - Magnetic Parts Dish



51353 - Claw Hammer 16 oz



51360 - Rubber Mallet



51361 - Plastic-Rubber Mallet
 Head Iron + PVC

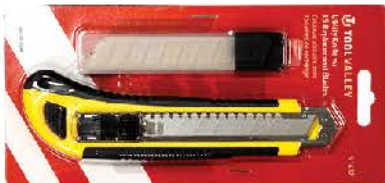

51432 - Utility knife with self-feeding
 Includes 15 3/4" replacement blades



51441 - Magnetic Nut Driver Set 4 pcs
 Sizes: 1/4", 5/16", 3/8", 7/16",
 1/4" drive & hex shank



51443 - L.E.D. Head Lamp
 3 high intensity LED bulbs -2 white & 1 red





Impulse Buy Products



51452 - Plier Set 2 pcs
5" long nose pliers & 4-1/2" diagonal pliers



51446 - Micro-driver Bit Set 10 pcs
Includes 3 Phillips bits, 3 slot bits, 3 star bits & bit holder



51451 - Tamper Proof Star Key Set 10 pcs
Includes T-10, T-15, T-20, T-25, T-27, T-30, T-40, T-45, T-50 + holder



51459 - Long Needle Nose Pliers 6"



51453 - Air Blow Gun, Pistol Type
Rated pressure 100 PSI



51456 - 4" Power Grip Vacuum Cup
Maximum capacity 20 kg

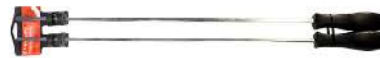

51472 - Extra Long Screwdriver Set 2 pcs

18" x #2 Phillips, 18" x 1/4" slot



51473 - 1/4" Drive Extension Set 3 pcs

Sizes 3", 6", 9"



51474 - Hacksaw Blade Set 12 pcs



51478 - Telescoping Magnet 8 lb



51479 - Inspection Mirror 2"



51493 - Receptacle Tester
For use on 110-125 V AC receptacles only



51487 - 48" Elastic Cord with Hook 2 pcs



51498 - Sink and Drain Cleaner
Size: 10" length x 0.2" diameter





51490TC - Twine Assortment 5 pcs
50M core wound rolls



51217 - AC/DC Multi Tester



51494 - Safety Vest
Onse size fits all 24" x 27"



51480 - Big Handle Screwdriver Set 2 pcs
Includes 1/4" x 6", #2 x 6", 6"



51333 - Extended Scraper



51126 - S.A.E. 3/8" Socket Set with Rail, 7 pcs.
Includes 5/16", 3/8", 7/16", 1/2", 9/16", 5/8" + rail



51125 - Metric Socket Set with Rail, 7pcs (3/8" drive).
Includes 8mm, 10mm, 12mm, 13mm, 14mm, 15mm + rail



51484 - Log Splitter Drill Bit



51499 - Tweezer Set



Impulse Buy Products





Impulse Buy **Blue Table** Products

- The Tool Valley **Blue** Impulse Buy Table is the perfect way to drive sales of those last minute purchases by your customers.
- The products in the blue table are all sold at a low \$15.98 price point.
- Our No-risk Guarantee ensures that the products that don't sell can be returned and replaced with faster moving products at no charge.
- Contact your Account Manager or Dynaline customer service for more information on the Impulse Buy Tables.



COMPACT TABLE
36" x 36"

15.98
EACH

Impulse Buy Products

PART#	CONTENTS
BLUE-TABLE	Blue Table Merchandiser - 69 part #s, 142 pieces.
WRD-3030	36" x 36" Double Wire Table Display Only (Include 4 Casters)
51078-08	Blue Table Sign Only (Bilingual)

ZERO RISK!

Stock Protection Guarantee for 2 years!

If it doesn't sell, we will take it back without penalty!





51603 - 3/8" Driver Socket Set 10 pcs

Includes 3/8 Dr. Ratchet, 3" x 3/8" extension bar, 5/8" x 3/8" Dr. spark plug socket & 7 3/8" Dr. shallow sockets



51604 - 1/4" Drive Socket Set 22 pcs

Includes 9 Sizes (SAE), 9 Sizes (Metric), 1/4" spinner handle, spin disc, 2" extension bar, 5" ratchet handle.



51606 - Ratchet Tie Down 2" x 20'



51607 - 10" Adjustable Wrench



51617 - PVC Pipe Cutter



51627 - Framing Hammer 24 oz



51630 - Screwdriver Set 8 pcs

Includes 6"x 5/16"; 4"x 3/16", 3"x 1/8", 3"x #1, 4"x #2, 6"x #2, 1-1/2"x 1/4", 1-1/2"x #2.



51640 - Plier Set 3 pcs

Sizes: 6" long nose plier, 6" linesman plier, 6" diagonal plier



51645 - 26" Mirror and Magnet Set 2 pcs



51649 - 3 lb Fiber glass Sledge Hammer



51650 - Mini Plier Set 3 pcs



51655 - 3/8" Metric Deep Socket Drive Set 6 pcs

Sizes: 10MM, 12MM, 13MM, 14MM, 15MM, 18MM.



51652 - Punch and Chisel Set 7 pcs

Contains 3-cold chisels: 3/8", 1/2", 5/8"; 4-pin punches: 3/16" pin punch, 1/8" and 3/16" taper punch, 3/8" center punch.



51654 - 3/8" S.A.E. Deep Socket Drive Set 6 pcs

Sizes: 3/8", 7/16", 1/2", 9/16", 5/8", 3/4".



Impulse Buy Products

Blue Impulse Buy Products

1.877.453.3964

1.877.453.5050

www.dynaline.com

@orders@dynaline.com



Impulse Buy Products



51657 - AC / DC Multi Tester
7 functions, 19 ranges.
1,000 Volt maximum



51677 - Tamper Proof Star Socket Set
9 pcs
Sizes: T15, T20, T25, T27, T30, T40, T45, T50 + rail



51682 - 10" Groove Joint Pliers
Features 5 positions & 1-1/2" capacity



51684 - S.A.E. Ball Hex Key Set 13 pcs
Include: 1/20, 1/16, 5/64, 3/32, 7/64, 1/8, 3/8, 9/64, 5/32, 3/16, 7/32, 1/4, 5/16.



51691 - 6' x 1" CamBuckle Set 2 pcs



51692- 1-1/2 lb Dead Blow Hammer



51694 - S.A.E. Hollow Shaft Nut Driver Set 7 pcs
Includes S.A.E. sizes: 3/16", 1/4", 5/16", 11/32", 3/8", 7/16", 1/2".



51902- Cable Tie Set 800 pcs
Contains 650-4", 100-6", 30-8", 20-10" cable ties.



51941- Heavy Duty 12" Hacksaw



51948 - 14' Tow Rope 4400lb capacity



52010 - Grab-it-Gadget
19" telescopic claw



53945-DB- Read Easy S.A.E. Tape Measure
25' x 1"



56102 - Heavy Duty Long Stretch Cord Set 20 pcs
Includes four each of: 12", 18", 24", 30" and 36".



56122 - 1" x 15' Ratchet Tie Down Set
2 pcs
Features vinyl coated S-hooks



56123 - Rubber Tie Down Strap Set
6 pcs
Includes two each: 9", 15", 21".





56125 - Automotive Fuse Assortment 75 pcs
 Includes 12 - 5A, 12 - 10A, 12 - 15A, 12 - 20A, 12 - 25A, 12 - 30A, 1-fuse puller, 1- 6-24 Volt tester, 1-Plastic case



56126- Snap Ring Plier Set 3 pcs
 Includes 6" & 8" straight tip and 8" 90 degree tip



56128 - S.A.E. Combination Wrench Set 6 pcs
 Size: 5/16", 3/8", 7/16", 1/2", 9/16", 5/8"



56130- Crimping Tool and Terminal Kit 101 pcs



56131- 11" Extra Long Needle Nose Pliers



56143 - Mechanics Gloves, Black
 Size: Large



56144- Mechanics Gloves, Black
 Size: X-Large



56146- Folding Utility Knife
 Includes 5 utility blades



56147 - 3" Long Power Bit Set 29 pcs
 Includes Slot -3 pc, Phillips -3 pc, Hex-6 pc, T-cross-3 pc, Tamper Proof star-6 pc, triwing -4 pc and pozi-3 pc + bit holder



56150- Screwdriver Bit Set 30 pcs



56160- Mini Car Fuse Assortment 80 pcs
 Includes: 10 each of 2A, 5A, 7.5A, 10A, 15A, 20A, 25A, 30A



56168 - 30-in-1 Micro Precision Bit Set
 Includes: 10 star bits, 8 hex bits, 5 slot bits, 4 Phillips bits, 2 pozi bits and screwdriver handle



56169- O-Ring Set 225 pcs
 18 popular sizes in a handy storage case



56170- Ball Hex and Star Driver Set 16 pcs
 Contains tamper proof star: T-9, T-10, T-15, T-20, T-25, T-27, T-30, T-40



56172 - Mechanics Pick Hook and Driver Set with Case 8 pcs
 Handle sizes: straight: 45, 90, 120 degree, PH0, PH00, slotted: 2.5mm and 30 mm. Comes with a tool bag.

Impulse Buy Products

Blue Impulse Buy Products

1.877.453.3964

1.877.453.5050

www.dynaline.com

orders@dynaline.com

Impulse Buy Products



56175 - Easy Out and Drill Bit Set 12 pcs
Includes 6 easy out: #1, #2, #3, #4, #5 and #6. 6 drill bits: 3/32", 1/8", 3/16", 1/4", 5/16" and 3/8"



56181 - Wire Brush Set 8 pcs
All brushes with 1/4" shank, brass bristles, and maximum load speed of 4500 RPM



56188 - Cushion Grip Screwdriver Set 5 pcs
Sizes: 1/4" x 6" slot, #2 x 4" Phillips, #1 x 3" Phillips, #1/4" x 4" slot, #2 x 6" Phillips



56189 - High Speed Drill Bit Set 16 pcs
Sizes: 1/16", 5/64", 3/32", 7/64", 1/8", 9/64", 5/32", 11/64", 3/16", 13/64", 7/32", 15/64", 1/4", 9/32", 5/16" and 19/64"



56191 - Hollow Punch Set 6 pcs
Sizes: 3/16", 1/4", 5/16", 3/8", 7/16", 1/2"



56193 - Contractor's Screwdriver Set 10 pcs
Five slots: 5/16" x 8", 1/4" x 6", 1/4" x 4", 1/8" x 3" pocket slot, 1/4" stubby slot. Five Phillips: #1 x 3", #2 x 4", #3 x 6", #0 x 3" pocket Phillips, #2 stubby Phillips.



56197 - 3/8" S.A.E. Drive Hex Bit Socket Set 10 pcs
Includes: 5/64", 3/32", 1/8", 5/32", 3/16", 7/32", 1/4", 5/16", 3/8". Plus storage rack



56199 - 3/8" Metric Drive Hex Bit Socket Set 10 pcs
Includes 2MM, 3MM, 4MM, 5MM, 6MM, 7MM, 8MM, 9MM and 10MM. Plus storage rack



56200 - Claw Hammer 16 oz.



56201 - Micro Fuse Set 80 pcs
Includes 10 each of: 2A, 5A, 7.5A, 10A, 15A, 20A, 25A and 30A.



56203 - Heavy Duty Voltage Tester
Use to check electrical circuits and accessories on all 6 and 12 Volt systems



56206 - Iron Padlock 75 mm
Comes with 3 keys



56209 - Ear Muffs and Safety Glasses
Impact resistant lenses. Reduces noise 21 dB. ANSI Z87.1 approved



56210 - Heavy Duty Tire Repair Kit 8 pcs



56213 - 6 Outlet Power Strip
60 cm cord length, SJT 14AWG#2C, AC 15A, 125V, 60HZ, 1875W. UL listed





56215 - Brush Set 7 pcs
 Contains three 7", three 8", one 9-3/4".
 Brass, nylon, stainless brushes



56216 - Rubber Mallet 32 oz



56217 - Dust Mask Set 60 pcs



**56218 - Bit Holder and Extension Set
 6 pcs**
 Contains 3 power extension bars: 1/4",
 3/8" and 1/2". 6" x 1/4" dr. hex flex
 extension bar, quick change holder and
 Magnetic screw holder.



56219 - Paint Brush Set 10 pcs
 Contains 2 of each size: 1", 2", 2-1/2", 3"
 and 1-1/2" angle



56223 - Utility Bar Tool - 18"



56225 - 4 Way Lug Wrench 14" Long S.A.E.
 Sizes: 11/16", 3/4", 13/16", 7/8".



56229 - Tri-Tap Extension Cord
 12 Gauge extra heavy duty 3
 outlet power cord. 18' Length



56230 - Long Blade Aviation Tin Snip
 12" long. Vinyl handle



56231 - Metric Tap Set 8 pcs
 Includes: tap handle and 7 taps. Taps:
 M3x0.5, M4x0.7, M5x0.8, M6x1.0,
 M8x1.25, M10x1.5, M12x1.75.



56232 - Screwdriver Kit 15 pcs
 Includes: 1 piece 2 in 1 "I" bit ratched
 driver. 1 piece magnetic bit holder. 1 piece
 level. 5 pieces 25mm bits: ph1, ph2, sl4,
 sl5, sl6. 1 piece 1m tape measure. 1 piece
 adaptor. 4 pieces 1/4" driver socket: 7mm,
 8mm, 9mm, 10mm. 1 piece storage box.



56233 - Extension Bar Set 5 pcs
 Includes: 3 pieces power socket adapter:
 1/4", 3/8" and 1/2". 1 piece 4-3/4" long
 extension bar. 1 piece 7" long flexible
 shaft.



Impulse Buy Products

Blue Impulse Buy Products

1.877.453.3964

1.877.453.5050

www.dynaline.com

orders@dynaline.com



56234 - Step Bit
10 Sizes: 1/4", 3/8", 1/2",
5/8", 3/4", 7/8", 1", 1-1/8",
1-1/4", 1-3/8"



56235 - Drill Eraser



56236 - Booster Cables



56237 - Stapler
Includes 200 staples



56238 - Drill Brushes Set
Set of 5 different brushes



56239 - Storage Straps
Includes: 4 @ 1x7, 2 @ 1.5 x 10,
4 @ 2 x 13



56240 - 3 Pieces Stainless Steel Rulers
12", 18", 24"

Impulse Buy Products





Impulse Buy Black Table Products

- The Tool Valley Black Impulse Buy Table is the perfect way to drive sales of those last minute purchases by your customers.
- The products in the black table are all sold at a low \$21.98 price point.
- Our No-risk Guarantee ensures that the products that don't sell can be returned and replaced with faster moving products at no charge.
- Contact your Account Manager or Dynaline customer service for more information on the Impulse Buy Tables.



COMPACT TABLE
36" x 36"

21.98
EACH

PART#	CONTENTS
BLACK-TABLE	Black Table Merchandiser - 53 part #s, 114 pieces.
WRD-3030	36" x 36" Double Wire Table Display Only (Includes 4 casters)
51078-22	Black Table Sign Only (Bilingual)

ZERO RISK!
Stock Protection Guarantee for 2 years!
If it doesn't sell, we will take it back without penalty!



Impulse Buy Products



Impulse Buy Products

Black Impulse Buy Products

1.877.453.3964

1.877.453.5050

www.dynaline.com

orders@dynaline.com

Impulse Buy Products



77300 - 120V Heat Gun 1500 Watt

12.5 AMPS. Dual temperature setting
3 positions rocker switch: off, high
and low.



**77301 - Master Auto Fuse Assortment
88 pcs**

Includes: mini blade fuses, standard
blade fuses and maxi blade fuses



77302 - Pry Bar Set 4 pcs

Includes: 8, 12, 18 and 24" pry bars



77303 - Adapter and U-Joint Set 7 pcs

Adaptor sizes: 1/4" f to 3/8" m,
3/8" f to 1/4" m, 3/8" f to 1/2" m,
1/2" f to 3/8" m. U-joint sizes: 1/4,
3/8, & 1/2.



77304 - Titanium Drill Bit Set 22 pcs

Contains: 1/16, 5/64, 3/32, 7/64, 1/8,
9/64, 5/32, 11/64, 3/16, 13/64, 7/32,
15/64, 1/4, 17/64, 9/32, 19/64, 5/16,
21/64, 11/32, 23/64 & 3/8".

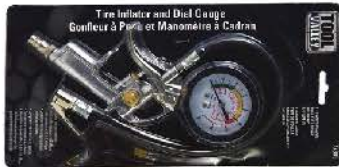

77305 - Tire Inflator and Dial Gauge

0 to 220 psi gauge. Ball type chuck
with clip. 1/4" npt (m).



77307 - Cross Pein Hammer 3 lb



77308 - Socket Set 52 pcs

Carbon steel construction. Contains
a variety of the most popular sizes of
sockets, spark plug sockets, extension
bars, ratchet handles, etc.



77309 - 6" Plier Set 4 pcs

Includes 4 pliers: 7" lineman,
6" diagonal, 6" slip-joint and
6" long nose pliers.



77306 - Self Adjusting Wire Stripper

Micro adjuster knob & wire stopper;
adjuster knob; stripping; crimping. Cuts
and strips 10-24 AWG copper or aluminum
wire. Terminal crimper 10-22 AWG
insulated and non-insulated. Auto Ignition
terminals 7-8 mm.





77310 - Screwdriver Bit Set 61 pcs
 2-1/2" magnetic bit holder. Contains assortment of phillips, slotted, star, tamper resistant star, pozidrive, hex, tamper resistant hex, and spanner bits in most popular sizes.



77311 - Screwdriver Set, 10 pcs
 Chrome vanadium shafts with magnetic tips. 8 assorted slotted, phillips and square drive screwdrivers. Includes mini magnetic parts dish and telescoping magnetic pick-up tool.



77312 - Adapter and U-Joint Set 7 pcs
 4 adapter sizes: 1/4" f to 3/8" m, 3/8" f to 1/4" m, 3/8" f to 1/2" m, 1/2" f to 3/8" m. 3 universal joint sizes: 1/4", 3/8" and 1/2" dr.



77313 - Multipurpose Razor Scraper Set
 Includes large scraper, mini razor scraper and safety cap. Comes with 10-pack of replacement blades



77314 - 180° Tubing Bender
 Makes short, smooth radius. Bends up to 180 degrees. Comes with a calibration gauge to indicate angle of bend for copper, aluminum and thin wall tubing. 3/8" max. bending capacity. For 1/4", 5/16", 3/8" o.d. tubing.



77315 - S.A.E. Tape Measure Set 4 pcs
 Contains 4 tape measures 12' x 5/8", 16' x 3/4", 25' x 1" and 33' x 1".



77316 - Ratcheting Wire Terminal Crimper
 Color coded wire sizes red: 22-18awg-dln 0.5-1.0mm blue: 16-14awg-dln 1.5mm-2.5mm yellow: 12-10awg-dln 4-6mm.



77317 - Utility Pick-up Tool Set 3 pcs
 Includes mini magnetic tray, telescoping inspection mirror and telescoping magnetic pickup tool



77318 - S.A.E. O-Ring Assortment 407 pcs



77319 - 3/8" x 50' PVC Air Hose
 Includes 1/4" npt male fittings at each end. Working pressure: 300 psi, burst pressure: 1200 psi.



77320 - Extra Long Ratchet 1/2" drive
 Extra-long for increased torque. Offset design quick-release feature. 36-tooth gear-drive ratchet mechanism for torque applications



77321 - Offset Micro Bit Driver with Bits
 Contains: ph1, ph2, st: 1/4" & 3/16", t-15, t-20, r1, r2 bit driver: 43ft/lbs of torque.





Impulse Buy Products



77322 - Impact Reducer Adapter Set 3 pcs
 Sizes: 3/4" f x 1/2" m, 1/2" f x 3/8" m, 3/8" f x 1/4" m



77323 - 3/8" and 1/2" Drive Offset Ratchet
 Drive offset dual-head ratchet. 72 tooth ratchet mechanism engages with just 5 degrees of sweep



77324 - Multi Use Power Bit Set 45 pcs
 Includes: 7 power nut drivers, 27 various screwdriver bits, 5 high-speed steel quick disconnect drill bits, 1/4" adaptor, magnetic bit extension and more packaged in a blow molded case



77325 - Metric O-Ring Assortment 419 pcs



77326 - Screw Extractor / Left Hand Drill Bit 10 pcs
 5 reverse drill bits, sizes 5/64, 7/64, 5/32, 1/4, 19/64 5 screw extractors, sizes: #1 - #5



77327 - Star Socket Bit Set, 9 pcs
 Sizes: t10,t15,t20,t25,t27,t30,t40,t45 & t50. 3/8" drive storage rail included.



77328 - Compound Action Cable Cutters
 10" overall height. Cuts copper and aluminum electric cable up to 1/2" diameter



77329 - Heat Shrink Tube Kit 171 pcs
 Includes various colors and sizes.



77330 - Metric NonSlip Hex Key Set, 9pc
 Contains 1.5, 2, 2.5, 3, 4, 5, 6, 8 and 10mm keys.



77331 - Composite Digital Caliper
 Inside, outside and depth measurements. Zinc alloyed range: 6" (150mm). Throat depth: 1.5". Overall length: 9.5" easy to read lcd display. Set zero at any position in measuring range. Impact resistant. Includes -1 1.5v battery



77332 - Folding Utility Knife - 2 Pack



77333 - S.A.E. Stubby Wrench Set 7pc
 Contains: 3/8, 7/16, 1/2, 9/16, 5/8, 11/16 & 3/4" wrenches.





77334 - Seal & O-Ring Remover Set 4pcs
 Includes: 2 contoured tip and 2 spoon tip lengths: 5-1/2" and 8-1/2".



77335 - Metric Grease Fit Assort 110pc
 Straight Includes: 30pc m6x1, 20pc m8x1, 20pc m10x1. 90 degrees
 Includes: 20pc m6x1, 10pc m8x1, 10pc m10x1



77336 - S.A.E. Combo Wrench Set 11pc
 Sizes: 1/4, 5/16, 3/8, 7/16, 1/2, 9/16, 5/8, 11/16, 3/4, 13/16 & 7/8".



77337 - 18" Bolt Cutter



77338 - Metric Stubby Wrench Set 7pc
 Contains: 10, 11, 12, 13, 14, 15 & 18mm wrenches.



77339 - Dr. Breaker Bar
 1/2" dr. Breaker bar. 18" extra long length.



77341 - 1/4 & 3/8" Dr. Offset Ratchet
 Drive offset dual-head ratchet. 72 tooth ratchet mechanism engages with just 5 degrees of sweep



77342 - Internal Pipe Wrench Set 3pc
 Includes 3/8", 1/2" and 3/4" internal pipe wrench



77343 - Security Bit Set 100 pc
 Contains: phillips, slotted, square drive, star, pozi-drive, inch and metric hex, tamper resistant star, tamper resistant hex, clutch drive, spline drive, spanner, three wing and four wing drives



77344 - 3/8" Dr S.A.E. Hex Bit Socket 10pc
 3/8" drive. Contains 10 bits: 3/32, 7/64, 1/8, 9/64, 5/32, 3/16, 7/32, 1/4, 5/16 and 3/8". 3/8" drive storage rail included.



77345 - Mini Precision Plier Set - 5pc
 5 most popular pliers: diagonal cutters, flat nose pliers, needle nose pliers, linesman pliers and end nipper.



77346 - Nylon Scraper Set - 4 pc
 Sizes: 3/4, 7/8, 1 & 1/2. Edges can be re-sharpened.





Impulse Buy Products



77347 - Scraper Set - 22pcs

Includes: 11 0.020" razor blades, 10 non-marring scraper blades, 1 9" razor scraper.



77348 - 3/8" Dr. Metric Hex Bits - 10pcs

3/8" drive. Includes 10 bits: 2, 3, 4, 5, 5.5, 6, 7, 8, 9 and 10mm. Storage rail included.



77349 - 12" Groove Joint Pliers



77351 - 12" High Torque Ratcheting Dr

Includes 12 screwdriver bits: 3 phillips #1, #2, #3. 4 slotted 5/32, 3/16, 1/4, 9/32. 2 star t15, t20.1 square #2. 2 hex 5/32, 3/16. 1 socket adapter 1/4" hex to 1/4" dr.



77352 - S.A.E. Non Slip Hex Key Set 13pc

Contains: 0.05", 1/16", 5/64", 3/32", 7/64", 1/8", 9/64", 5/32", 3/16", 7/32", 1/4", 5/16" and 3/8"



77353 - Metric Combo Wrench Set 11pc

Metric sizes: 8, 9, 10, 11, 12, 13, 14, 15, 16, 17 & 18mm



77354 - Mini Pistol Grease Gun Kit

Includes a 5" steel extension and grease coupler. Working pressure 2000 psi. Comes with one 85gr (3oz) grease cartridge.



77355 - Ultimate Grab-it Gadget

19" telescopic claw. 23" telescopic magnet (holds up to 2 lbs). Led flashlight.



77356 - 48-in-1 Multifunction Socket Wrench

Size: 8mm and 5/16; 10mm and 3/8; 11mm and 7/16; 13mm and 1/2; 14mm and 9/16, 16mm and 5/8; 17mm and 11/16; 19mm and 3/4.



77357 - Pry Bar Set 3 pcs

Includes: 13" x 1.5" wrecking bar, 10" wrecking bar, and 11" wrecking bar with handle.



77358 - Brick Bolster Cold Chisel 4"

4" tip size and 8-1/2" long.



77359 - Flat Edge Cold Chisel 7/8"

7/8" tip size and 11" long.





77360 - Fencing Plier 10"

Seven Pliers in one: Two Wire Splicing Channels, Milled Hammer Face, Staple Puller Claw, Twin Wire Cutters, and a Gripping Jaw.



77361 - Crimper



77362 - Hammock

Includes Rope & Carabiners



77363 - Oil Filter Pliers

Adjustable from 2-1/2 to 5-1-2"



77364 - 50m Measuring Reel



BOSS PRODUCTS



A		Plastic Cutters	121
Assorted Impact Bit Bar	117	Pozi - Plain Finish Bits	112
Assortment - Pack Driver Bit	117	Q	
Assortment - Professional Bits and Nut Drive Set	119	Quick Release - 6" Holder	114
Assortment - Professional Impact Driver Bits	119	R	
C		Regular Blades	124
Carpenter Pencil Accessories	125	Retractable Collar - Magnetic Rim	114
Ceiling Bit Holder	114	Robertson - Branded Impact Bits	110
Ceiling Bit Holder	114	Robertson - Color Coded Bits	109
Cobalt Drill Bits	120	Robertson - Plain Finish Bits	109
Comfort Grip Cutter	122	Robertson & Philips Bit Bars	116
Compact Driver Bit Display	107	Robertson Bit Bars	115
D		Robertson Bit Bars	116
Damaged Screw Remover	120	Robertson Red Bitbar	117
Deck Driver with Stopper	114	S	
Deep Hole Nut Drivers - Colour Coded	113	Safety Cutter	122
Drill Bit Display	106	Safety Utility Blade -2 Notch	125
Driver Bit Kit Display	107	Single Edge Razor Blade	125
Dry Wall Plain Finish Bit Stopper	112	Slotted - Plain Finish Bits	111
E		Socket Adapter Set	120
Ergo Grip Cutters	122	Socket Holders - Plain Finish	113
Ergonomic Serrated Blade Cutter	122	Square - Magnetic Impact Bits	110
H		Standard Carpenter Pencils	125
Heavy Duty - Quick Change Adapter	114	T	
Heavy Duty Blade	124	Three-Blade Cutter Display	108
Heavy Duty Hi Carbon	124	TORX - Plain Finish Bits	112
Heavy Duty Knob Lock Cutter	122	Torx Bit Bar	117
Heavy Duty SK2 Serrated Blade	125	Torx Tamper Proof - Plain Finish Bits	112
Hex / Allen - Plain Finish	111	W	
Hex Tamper Proof - Plain Finish Bits	109	Waterproof Padlocks	126
I			
Industrial Security Set	120		
M			
Magnetic Bit Holders	114		
Magnetic Insert Holder	114		
Magnetic Nut Drivers - Colour Coded	113		
Magnetic Nut Drivers - Plain Finish	113		
Magnetic Nut Drivers Bit Bar	118		
Measuring Tapes	123		
Measuring Tapes	124		
Merchandiser - Cutters and Blades	106		
Merchandiser - Driver Bit	107		
Merchandiser - Padlock	106		
Metric Magnetic Nut Drivers	118		
Metric Magnetic Nut Drivers - Plain Finish	113		
P			
Padlocks	126		
Phillips - Colour Coded Bits	110		
Phillips - Plain Finish Bits	111		
Phillips Bit Bars	116		





Your Trusted Source.



Boss Products

Dynaline BOSS Products Merchandisers

Dynaline offers merchandisers for almost every product. Merchandisers keep your stock organized, visible and easy to shop.



BOSS Padlock Merchandiser

PART#	CONTENTS
00225	Padlock Display Board Only, 24" x 24"
00225K	Full Padlock Merchandiser. Includes 00225 display board, 16 pegs (80004) and products.

i Full product breakdown on page 64

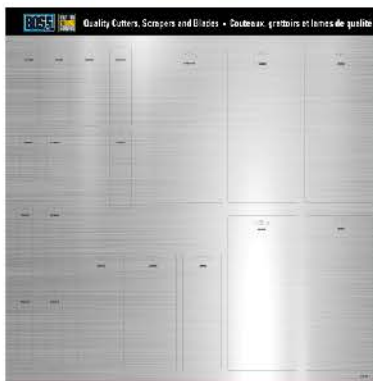

BOSS Quality Cutters and Blades Merchandiser

PART#	CONTENTS
77810	Cutter Display Board Only, 24" x 24"
77810K	Full Cutter Merchandiser. Includes 77810 display board, 19 pegs (80004) and products.

i Full product breakdown on page 64



Drill Bit Display

PART#	CONTENTS
100811	Drill Bit Display Only. 27" x 18.5" x 17"
77890	Full Drill Bit Merchandiser. Includes 25 Pieces, display, labels and the products.

i Full product breakdown on page 65

Sizes are approximate. Specifications subject to change without notice.



Counter-top BOSS Driver Bit Kit Display

PART#	CONTENTS
100854	Driver Bit Kit Display Only . Includes decals. (Bit Kits sold separately)

i Full product breakdown on page 66



Counter-top BOSS Compact Driver Bit Display

PART#	CONTENTS
77799	Full Driver Bit Kit Merchandiser . Includes display, labels and 307 pieces. Size: 5" x 7" x 9"
100859	Driver Bit Kit Display Only . Includes decals.

i Full product breakdown on page 67



Small Rotating Driver Bit Merchandiser

PART#	CONTENTS
77806K	Small Rotating Driver Bit Display - Display and Products
77806	Small Rotating Driver Bit Display - Display Only

i Full product breakdown on page 69



Large Rotating Driver Bit Merchandiser

PART#	CONTENTS
77808K	Large Rotating Driver Bit Display - Display and Products
77808	Large Rotating Driver Bit Display - Display Only

i Full product breakdown on page 68

Sizes are approximate. Specifications subject to change without notice.





Boss Products



Three-Blade Cutter Display

PART#	CONTENTS
100857	Display Only. 7.5" x 12" x 15/5"
558601	Three-Blade Cutter Display. Includes 3 types of blades.

i Full product breakdown on page 67



THIS ITEM IS CUSTOMIZABLE

Plastic Cutter, 3/4" Blade



★ YOUR LOGO HERE

THIS ITEM IS CUSTOMIZABLE

15mm Carpenter Pencils



THIS ITEM IS CUSTOMIZABLE

Utility Grade
Professional Grade
Extra Long
Premium



Sizes are approximate. Specifications subject to change without notice.

Robertson - Color Coded Bits

- 2 piece construction made of modified S2 Japanese steel designed for 1/4" impact drivers.
- Only genuine Robertson® colour coded 1/4" hex driver bits have "Cling Fit". Made with our genuine Robertson® Tip



*Image is not to scale

PART#	COLOUR	SIZE	LENGTH	PKG
72100	Yellow	#0	1"	5
72101	Green	#1	1"	5
ooo 72102	Red	#2	1"	5
ooo 72103	Black	#3	1"	5
ooo 72120	Yellow	#0	2"	5
ooo 72121	Green	#1	2"	5
ooo 72122	Red	#2	2"	5
ooo 72123	Black	#3	2"	5
72130	Yellow	#0	3"	5
ooo 72131	Green	#1	3"	5

PART#	COLOUR	SIZE	LENGTH	PKG
ooo 72132	Red	#2	3"	5
ooo 72133	Black	#3	3"	5
72141	Red	#2	6"	5
72142	Black	#3	6"	5
72143	Green	#1	12"	5
ooo 72151	Green	#1	6"	5
ooo 72152	Red	#2	6"	5
ooo 72153	Black	#3	6"	5
72181	Green	#1	12"	5
72182	Black	#3	12"	5
72183	Black	#3	12"	5

Robertson - Plain Finish Bits

- 2 piece construction made of modified S2 Japanese steel designed for 1/4" impact drivers.
- steel designed for 1/4" impact drivers.



PART#	SIZE	LENGTH	PKG
ooo 78101	#1	1"	5
ooo 78102	#2	1"	5
ooo 78103	#3	1"	5
78120	#0	2"	5
ooo 78121	#1	2"	5
ooo 78122	#2	2"	5

PART#	SIZE	LENGTH	PKG
ooo 78123	#3	2"	5
78130	#0	3"	5
78131	#1	3"	5
78132	#2	3"	5
ooo 78133	#3	3"	5
ooo 78151	#1	6"	5
ooo 78152	#2	6"	5
ooo 78153	#3	6"	5

Hex Tamer Proof - Plain Finish Bits

- Blunt tip for better seating
- Straight sides for additional torque
- 1/4" hex shafts



*Image is not to scale

PART#	SIZE	LENGTH
78551	3/32	2"
78552	7/64	2"
78553	1/8	2"
78554	9/64	2"

PART#	SIZE	LENGTH
78555	5/32	2"
78556	3/16	2"
78557	7/32	2"
78558	1/4	2"

Sizes are approximate. Specifications subject to change without notice.





Robertson - Branded Impact Bits

- 1 piece construction, colored sleeve, for 1/4" impact drivers.

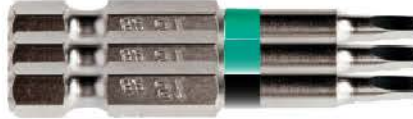

*Image is not to scale

PART#	COLOUR	SIZE	LENGTH
74121	Green Band	#1	2"
74122	Red Band	#2	2"

PART#	COLOUR	SIZE	LENGTH
74123	Black Band	#3	2"



Square - Magnetic Impact Bits

- 1 piece construction, Colored sleeve, for 1/4" drivers



*Image is not to scale

PART#	COLOUR	SIZE	LENGTH
75121	Green	#1	2"
75122	Red	#2	2"
75123	Black	#3	2"
75131	Green	#1	3"
75132	Red	#2	3"
75133	Black	#3	3"

PART#	COLOUR	SIZE	LENGTH
75141	Green	#1	4"
75142	Red	#2	4"
75143	Black	#3	4"
75151	Green	#1	6"
75152	Red	#2	6"
75153	Black	#3	6"



Phillips - Colour Coded Bits

- Quality controlled engineering for maximum torque
- 1/4" hex shafts fit ball retainer and regular style chucks

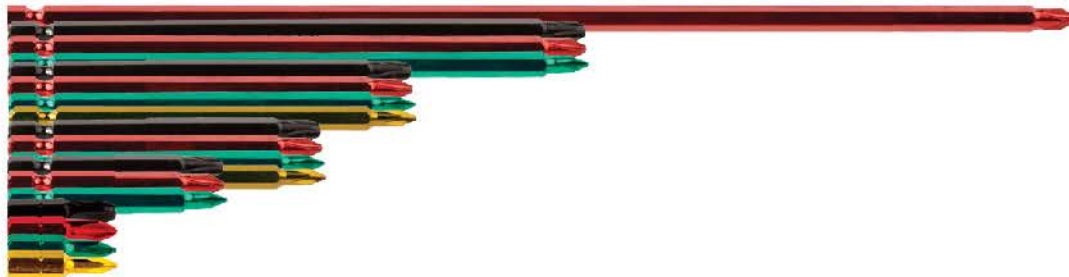

*Image is not to scale

PART#	COLOUR	SIZE	LENGTH	PKG
72200	Yellow	#0	1"	5
72201	Green	#1	1"	5
72202	Red	#2	1"	5
72203	Black	#3	1"	5
72220	Yellow	#0	2"	5
72221	Green	#1	2"	5
72222	Red	#2	2"	5
72223	Black	#3	2"	5
72230	Yellow	#0	3"	5
72231	Green	#1	3"	5

PART#	COLOUR	SIZE	LENGTH	PKG
72232	Red	#2	3"	5
72233	Black	#3	3"	5
72241	Green	#1	4"	5
72242	Red	#2	4"	5
72243	Black	#3	4"	5
72251	Green	#1	6"	5
72252	Red	#2	6"	5
72253	Black	#3	6"	5
72282	Red	#2	12"	5

Sizes are approximate. Specifications subject to change without notice.



Phillips - Plain Finish Bits

- Quality controlled engineering for maximum torque
- 1/4" hex shafts fit ball retainer and regular style chucks



*Image is not to scale

PART#	SIZE	LENGTH	PKG
78220	#0	2"	5
78221	#1	2"	5
78222	#2	2"	5
78223	#3	2"	5

PART#	SIZE	LENGTH	PKG
78230	#0	3"	5
78231	#1	3"	5
78232	#2	3"	5
78233	#3	3"	5

Slotted - Plain Finish Bits

- Quality controlled engineering for maximum torque
- 1/4" hex shafts fit ball retainer and regular style chucks



*Image is not to scale

PART#	SIZE	LENGTH
78320	5/32"	2"
78321	3/16"	2"
78322	1/4"	2"

PART#	SIZE	LENGTH
78323	9/32"	2"
78331	3/16"	3"
78332	1/4"	3"

Hex / Allen - Plain Finish

- Ideal for automotive and machinery fasteners
- 1/4" hex shaft fits ball retainer and regular style chucks
- Chrome vanadium steel construction to withstand heavy use



*Image is not to scale

PART#	SIZE	LENGTH
78520	3/32"	2"
78521	7/64"	2"
78522	1/8"	2"
78523	9/64"	2"

PART#	SIZE	LENGTH
78524	5/32"	2"
78525	3/16"	2"
78526	7/32"	2"
78527	1/4"	2"

Sizes are approximate. Specifications subject to change without notice.





TORX - Plain Finish Bits

- Through Hardened for exceptional durability.
- 1/4" Hex shafts
- Exact fit Torx tips for reduced cam out



*Image is not to scale

PART#	SIZE	LENGTH
78400	T10	1"
78401	T15	1"
78402	T20	1"
78403	T25	1"
78404	T30	1"
78405	T40	1"
78406	T27	1"
78417	T7	2"
78418	T8	2"
78419	T9	2"
78420	T10	2"

	PART#	SIZE	LENGTH
ooo	78424	T30	2"
ooo	78425	T40	2"
	78426	T27	2"
	78427	T45	2"
	78428	T50	2"
	78429	T55	2"
	78430	T10	3"
	78431	T15	3"
	78432	T20	3"
	78433	T25	3"
	78434	T30	3"
	78435	T40	3"
	78436	T27	3"
ooo	78421	T15	2"
ooo	78422	T20	2"
ooo	78423	T25	2"



Pozi - Plain Finish Bits

- Blunt tip for better seating
- Straight sides for additional torque
- 1/4" Hex shafts



*Image is not to scale

PART#	SIZE	LENGTH
78620	#0	2"
78621	#1	2"
78622	#2	2"
78623	#3	2"



Dry Wall Plain Finish Bit Stopper



- 1/4" Hex shafts

PART#	SIZE	LENGTH
80228	#2	1"



Torx Tamper Proof - Plain Finish Bits

- Blunt tip for better seating
- Straight sides for additional torque
- 1/4" hex shafts



*Image is not to scale

	PART#	SIZE	L
ooo	78450	T10	2"
ooo	78451	T15	2"

	PART#	SIZE	L
ooo	78454	T27	2"
	78455	T30	2"
	78456	T40	2"
ooo	78452	T20	2"
ooo	78453	T25	2"

Sizes are approximate. Specifications subject to change without notice.



Boss Products



Magnetic Nut Drivers - Colour Coded



**Image is not to scale*

PART#	COLOUR	HEAD	LENGTH	DIA	PKG
73110	Yellow	1/4"	2-1/2"	1/4"	5
73111	Green	5/16"	2-1/2"	1/4"	5
73112	Red	3/8"	2-1/2"	1/4"	5
73113	Brass	7/16"	2-1/2"	1/4"	5
73114	Black	1/2"	2-1/2"	1/4"	5
73115	Blue	9/16"	2-1/2"	1/4"	5

Deep Hole Nut Drivers - Colour Coded



**Image is not to scale*

PART#	COLOUR	HEAD	LENGTH	DIA	PKG
73210	Yellow	1/4"	2-1/2"	1/4"	5
73211	Green	5/16"	2-1/2"	1/4"	5
73212	Red	3/8"	2-1/2"	1/4"	5
73213	Brass	7/16"	2-1/2"	1/4"	5
73214	Black	1/2"	2-1/2"	1/4"	5

Magnetic Nut Drivers - Plain Finish



**Image is not to scale*

PART#	HEAD	LENGTH	DIA	PKG
79110	1/4"	2-1/2"	1/4"	5
79111	5/16"	2-1/2"	1/4"	5
79112	3/8"	2-1/2"	1/4"	5
79113	7/16"	2-1/2"	1/4"	5
79114	1/2"	2-1/2"	1/4"	5
79310	1/4"	6"	1/4"	5
79311	5/16"	6"	1/4"	5
79312	3/8"	6"	1/4"	5
79313	7/16"	6"	1/4"	5
79314	1/2"	6"	1/4"	5
79410	1/4"	1-3/4"	1/4"	5
79411	5/16"	1-3/4"	1/4"	5
79412	3/8"	1-3/4"	1/4"	5
79413	7/16"	1-3/4"	1/4"	5

Metric Magnetic Nut Drivers - Plain Finish



**Image is not to scale*

PART#	SIZE	LENGTH	DIA	PKG
79707	7mm	2-1/2"	1/4"	5
79708	8mm	2-1/2"	1/4"	5
79709	9mm	2-1/2"	1/4"	5
79710	10mm	2-1/2"	1/4"	5
79712	12mm	2-1/2"	1/4"	5
79715	15mm	2-1/2"	1/4"	5
79717	17mm	2-1/2"	1/4"	5

Socket Holders - Plain Finish



**Image is not to scale*

PART#	HEAD	LENGTH	DIA	PKG
79050	1/4"	1"	1/4"	5
79150	1/4"	2"	1/4"	5
79151	1/4"	3"	1/4"	5
79152	1/4"	4"	1/4"	5
79352	3/8"	2-9/16"	1/4"	5
79353	1/2"	2-3/4"	1/4"	5
79560	3/8"	2-7/16"	5/16"	5
79580	1/2"	2-7/16"	5/16"	5
79660	3/8"	2-7/16"	7/16"	5
79860	1/2"	2-7/16"	7/16"	5



Boss Products



Sizes are approximate. Specifications subject to change without notice.



Boss Products

Retractable Collar - Magnetic Rim



**Image is not to scale*

PART#	TYPE	HOLDER	LENGTH	DIA
79262	Magnet	1/4"	2-1/2"	1/4"

Deck Driver with Stopper



**Image is not to scale*

PART#	TYPE	HOLDER	LENGTH
82122	Sq#2 with Stopper	1/4"	2

Magnetic Bit Holders



**Image is not to scale*

PART#	HOLDER	LENGTH	DIA
79260	1/4"	2-1/2"	1/4"
79264	1/4"	4"	1/4"

Quick Release - 6" Holder



**Image is not to scale*

PART#	TYPE	HOLDER	LENGTH	DIA
79284	Magnet	1/4"	6"	1/4"

Ceiling Bit Holder



**Image is not to scale*

PART#	HOLDER	LENGTH	DIA
79268	1/4"	2-1/2"	1/4"

Heavy Duty - Quick Change Adapter



**Image is not to scale*

PART#	HOLDER	LENGTH	DIA
79440	1/4"	2"	1/4"

Magnetic Insert Holder



**Image is not to scale*

PART#	HOLDER	LENGTH	DIA	TYPE
79258	1/4"	2-2/5"	1/4"	C-Ring
79259	1/4"	2-1/2"	1/4"	Twist

* See Merchandiser section for details.

Sizes are approximate. Specifications subject to change without notice.



Boss Products



771225 - Robertson Sq#2 Bit Bar, 10 Pack
9771225 - Customized Robertson Sq#2 Bit Bar, 10 Pack

ADD YOUR NAME & LOGO

PART#	DESCRIPTION	QUANTITY
78122	S2 Sq#2 x 2"	10



711269 - Robertson Impact #2 Bit Bar, 10 Pack

9711269 - Customized Robertson Impact #2 Bit Bar, 10 Pack

ADD YOUR NAME & LOGO

PART#	DESCRIPTION	QUANTITY
74122	#2 x 2" Robertson Impact Bit Colored Band	10



711252 - Assorted Robertson Impact Bit Bar, 10 Pack
9711252 - Customized Assorted Robertson Impact Bit Bar, 10 Pack

ADD YOUR NAME & LOGO

PART#	DESCRIPTION	QUANTITY
74121	#1 x 2" Robertson Impact Bit	2
74122	#2 x 2" Robertson Impact Bit	6
74123	#3 x 2" Robertson Impact Bit	2



774202 - Torx Bit Bar, 10 Pack
9774202 - Customized Torx Bit Bar, 10 Pack

ADD YOUR NAME & LOGO

PART#	DESCRIPTION	QUANTITY
78417	S2 Torx T7 x 2"	1
78418	S2 Torx T8 x 2"	1
78419	S2 Torx T9 x 2"	1
78420	S2 Torx T10 x 2"	1
78421	S2 Torx T15 x 2"	1
78422	Torx T20 x 2"	1
78423	Torx T25 x 2"	1
78424	Torx T30 x 2"	1
78425	TorxT40 x 2"	1
78426	S2 Torx T27 x 2"	1

Sizes are approximate. Specifications subject to change without notice.





Boss Products



711201 - Assorted Robertson, Phillips & Slotted Bit Bar, 10 Pack
9711201 - Customized Assorted Robertson, Phillips & Slotted Bit Bar, 10 Pack

PART#	DESCRIPTION	QUANTITY
72120	Sq#0 x 2" 2pc Yellow	1
72121	Sq#1 x 2" 2pc Green	1
72122	Sq#2 x 2" 2pc Red	1
72123	Sq#3 x 2" 2pc Black	1
72220	Phillips #0 x 2" Yellow	1
72221	Phillips #1 x 2" Green	1
72222	Phillips #2 x 2" Red	1
72223	Phillips #3 x 2" Black	1
78321	S2 Slotted 3/16"x2"	1
78323	S2 Slotted 9/32"x2"	1



711221 - Robertson Sq#2 Bit Bar, 10 Pack
9711221 - Customized Robertson Sq#2 Bit Bar, 10 Pack

PART#	DESCRIPTION	QUANTITY
72122	Sq#2 x 2" 2pc Red	10



711294 - Square Magnetic Impact Round Body Bit Bar, 10 Pack
9711294 - Customized Square Magnetic Impact Round Body Bit Bar, 10 Pack

PART#	DESCRIPTION	QUANTITY
75122	Mag. Robertson Impact # 2 x 2"	10



711276 - Assorted Robertson & Phillips Bit Bar, 10 Pack
9711276 - Customized Assorted Robertson & Phillips Bit Bar, 10 Pack

PART#	DESCRIPTION	QUANTITY
72121	Sq#1 x 2" 2pc Green	2
72122	Sq#2 x 2" 2pc Red	3
72123	Sq#3 x 2" 2pc Black	1
72221	Phillips #1 x 2" Green	1
72222	Phillips #2 x 2" Red	2
72223	Phillips #3 x 2" Black	1



711245 - Assorted Rob. Bit Bar, 10 Pack
9711245 - Customized Assorted Rob. Bit Bar, 10 Pack

PART#	DESCRIPTION	QUANTITY
72121	Sq #1 x 2" - 2pc Green	3
72122	Sq #2 x 2" - 2pc Red	5
72123	Sq #3 x 2" - 2pc Black	2



712228 - Phillips Bit Bar, 10 Pack
9712228 - Customized Phillips Bit Bar, 10 Pack

PART#	DESCRIPTION	QUANTITY
72222	Phillips #2 x 2" Red	10

Sizes are approximate. Specifications subject to change without notice.



711306 - Assorted Impact Bit Bar, 10 Pack
9711306 - Customized Assorted Impact Bit Bar, 10 Pack

ADD YOUR NAME & LOGO

PART#	DESCRIPTION	QUANTITY
72221	Phillips #1 x 2" - Green	1
72222	Phillips #2 x 2" - Red	2
72223	Phillips #3 x 2" - Black	1
75121	Mag. Square Impact #1 x 2" - Green	2
75122	Mag. Square Impact #2 x 2" - Red	3
75123	Mag. Square Impact #3 x 2" - Black	1



771201 - Pack Driver Bit Assortment 10 Pack
9771201 - Customized Pack Driver Bit Assortment, 10 Pack

ADD YOUR NAME & LOGO

PART#	DESCRIPTION	QUANTITY
78120	S2 Sq #0 x 2"	1
78121	S2 Sq #1 x 2"	1
78122	Sq #2 x 2" Plain Finish	1
78123	S2 Sq #3 x 2"	1
78220	S2 Phillips #0 - 2"	1
78221	S2 Phillips #1 - 2"	1
78222	S2 Phillips #2 - 2"	1
78223	S2 Phillips #3 - 2"	1
78321	Slotted 3/16" x 2" Plain Finish	1
78323	Slotted 9/32" x 2" Plain Finish	1



774208 - Torx Bit Bar, 10 Pack
9774208 - Customized Torx Bit Bar Bitbar Set, 10 Pack

ADD YOUR NAME & LOGO

PART#	DESCRIPTION	QUANTITY
78420	Torx T10 x 2"	3
78423	Torx T25 x 3"	4
78424	Torx T30 x 2"	3



711321 - Robertson Red Bitbar Set, 10 Pack
9711321 - Customized Robertson Red Bitbar Set, 10 Pack

ADD YOUR NAME & LOGO

PART#	DESCRIPTION	QUANTITY
72132	Sq #2 x 3"	10

Sizes are approximate. Specifications subject to change without notice.





Boss Products



- 717186 - Magnetic Nut Drivers Bit Bar, 5 Pack
- 9717186 - Customized Magnetic Nut Drivers Bit Bar, 5 Pack

ADD YOUR NAME & LOGO

PART#	DESCRIPTION	QUANTITY
73110	Magnetic Nut Driver 1/4" x 2.5" - Yellow	1
73111	Magnetic Nut Driver 5/16" x 2.5" - Green	1
73112	Magnetic Nut Driver 3/8" x 2.5" - Red	1
73113	Magnetic Nut Driver 7/16" x 2.5" - Brass	1
73114	Magnetic Nut Driver 1/2" x 2.5" - Black	1



- 711103 - Magnetic Nut Drivers Bit Bar, 5 Pack
- 9711103 - Customized Magnetic Nut Drivers Bit Bar, 5 Pack

ADD YOUR NAME & LOGO

PART#	DESCRIPTION	QUANTITY
73110	1/4" Magnetic Nut Driver, 2.5" - Yellow	5



- 717209 - 5 Pack Magnetic Nut Driver
- 9717209 - Customized 5 Pack Magnetic Nut Driver

ADD YOUR NAME & LOGO

PART#	DESCRIPTION	QUANTITY
73110	Magnetic Nut Driver 1/4" x 2.5- Yellow	2
73112	Magnetic Nut Driver 3/8" x 2.5- Red	3



- 777586 - Metric Magnetic Nut Drivers Bit Bar, 5 Pack

- 9777586 - Customized Metric Magnetic Nut Drivers Bit Bar, 5 Pack

ADD YOUR NAME & LOGO

PART#	DESCRIPTION	QUANTITY
79708	Metric Magnetic Nut Driver #8x 2.5" long	1
79709	Metric Magnetic Nut Driver #9x 2.5" long	1
79710	Metric Magnetic Nut Driver #10 x 2.5" long	1
79712	Metric Magnetic Nut Driver #12 x 2.5" Long	1
79715	Metric Magnetic Nut Driver 15mm x 65mm	1



- 777588 - Metric Magnetic Nut, 5 Pack
- 9777588 - Customized Metric Magnetic 5 Pack

ADD YOUR NAME & LOGO

PART#	DESCRIPTION	QUANTITY
79709	9mm x 2.5"	1
79710	10mm x 2.5"	1
79712	11mm x 2.5"	1
79715	15mm x 2.5"	1
79717	17mm x 2.5"	1

Sizes are approximate. Specifications subject to change without notice.

000 **721386 - Professional Assortment Bits and Nut Drive Set, 18 Pack**

000 **9721386 - Customized Professional Assortment Bits and Nut Drive Set, 18 Pack**

ADD YOUR NAME & LOGO

PART#	DESCRIPTION	QUANTITY
72122	Sq#2 x 2" 2pc Red	2
72220	Ph#0 x 2" Yellow	1
72120	Sq#0 x 2" 2pc Yellow	1
72121	Sq#1 x 2" 2pc Green	1
72123	Sq#3 x 2" 2pc Black	1
72221	Ph#1 x 2" Green	1
72222	Ph#2 x 2" Red	2
72223	Ph#3 x 2" Black	1
73110	1/4" x 2.5" long Magnetic Nut Drive Yellow	1
73111	5/16" x 2.5" long Magnetic Nut Drive Green	1
73112	3/8" x 2.5" long Magnetic Nut Drive Red	1
73113	Brass Mag Nut Drive 7/16" x 2.5" long	1
000 73114	Black Mag Nut Drive 1/2"x 2.5" long	1
78321	S2 SL3/16"x2"	1
78323	S2 SL9/32"x2"	1
79260	Mag Insert Hold 1/4"x 60mm	1



*Image is not to scale



Boss Products

000 **721374 - Professional Assortment Impact Driver Bits, 18 Pack**

000 **9721374 - Customized Professional Assortment Impact Driver Bits, 18 Pack**

ADD YOUR NAME & LOGO

PART#	DESCRIPTION	QUANTITY
74121	#1 x 2" Robertson Impact Bit	1
74122	#2 x 2" Robertson Impact Bit	3
74123	#3 x 2" Robertson Impact Bit	1
72221	Phillips #1 x 2" - Green	1
72222	Phillips #2 x 2" - Red	2
72223	Phillips #3 x 2" - Black	1
78420	S2 TorqT10 x 2"	1
78421	S2 TorqT15 x 2"	1
78422	S2 TorqT20 x 2"	1
73110	1/4" x 2.5" Magnetic Nut Driver - Yellow	1
73111	5/16" x 2.5" Magnetic Nut Driver - Green	1
73112	3/8" x 2.5" Magnetic Nut Driver - Red	1
79150	Socket Holder 1/4" x 2" long	1
79352	Socket Holder 3/8" x 2.56" long	1
79353	Socket Holder 1/2" x 2.83" long	1



*Image is not to scale

Sizes are approximate. Specifications subject to change without notice.





Boss Products

Cobalt Drill Bits featuring Grizzly Tip

All bits are packaged for easy retail.

FEATURES

GRIZZLY TIP

Grizzly Tip™ is exclusively available from BOSS. It has excellent self centering characteristics. The center split point starts the cutting with the two sides (tips of the flutes) following close behind it providing 4 cutting edges. This increases the speed and smoothness of the drill and hole.



SOLID CONSTRUCTION

M35 is a high speed steel in the tungsten molybdenum series with 5% cobalt added. The additional cobalt increases heat resistance. The carbides in its are small and evenly distributed. It has high wear resistance. After heat treatment, its hardness is the same as T1, but its bending strength can reach 4700 MPa. It's toughness and thermo plasticity are higher than T1 by 50%.



3 GROUND FLAT

The triangle shank is made by machining three flats on a round bar stock. It is intended as a minor modification of a straight shank, still allowing it to be held in a 3-jaw drill chuck, also allowing higher TORX transmission and limited slipping.



PART#	DESCRIPTION	QTY/PKG	QTY/BOX
851000	1/16"	2	6
851002	5/64"	2	6
851004	3/32"	2	6
851006	7/64"	2	6
851008	1/8"	2	6
851010	9/64"	1	6
851012	5/32"	1	6
851014	11/64"	1	6
851016	3/16"	1	6
851018	13/64"	1	6
851020	7/32"	1	6
851022	15/64"	1	6
851024	1/4"	1	6
851026	17/64"	1	6
851028	9/32"	1	6

PART#	DESCRIPTION	QTY/PKG	QTY/BOX
851030	19/64"	1	6
851032	5/16"	1	6
851034	21/64"	1	6
851036	11/32"	1	6
851038	23/64"	1	6
851040	3/8"	1	6
851042	25/64"	1	6
851044	13/32"	1	6
851046	27/64"	1	6
851048	7/16"	1	6
851050	29/64"	1	6
851052	15/32"	1	6
851054	31/64"	1	6
851056	1/2"	1	6



Industrial Security Set

PART#	DESCRIPTION	PACK	CARTON
771395	33 Piece Industrial S2 Steel Security Set	Carded	10



Damaged Screw Remover

PART#	DESCRIPTION	PACK	BAR/CASE
771410	3 Pack industrial screw remover	Carded	12/48



3 Piece Socket Adapter Set

PART#	DESCRIPTION	PACK	BOX/CASE
793520	3 Piece socket adapter set	Carded	25/100

Sizes are approximate. Specifications subject to change without notice.

Plastic Cutter, 3/4" Blade

Available in Multiple color options and arrives in easy to setup counter-top display.

- Features:
- Slide lock
 - Snap off blade

PART#	ADD YOUR NAME & LOGO PART #	COLOUR	SHEATH/ LOCK	BLADE GRADE	BOX/ CASE
2558228	9008228	Red	Plastic / Thumb	Regular	48 / 480
2558229	9008229	Dark Green	Plastic / Thumb	Regular	48 / 480
2558230	9008230	Blue	Plastic / Thumb	Regular	48 / 480
2558231	9008231	Yellow	Plastic / Thumb	Regular	48 / 480
2558232	9008232	Orange	Plastic / Thumb	Regular	48 / 480
2558233	9008233	Light Green	Plastic / Thumb	Regular	48 / 480
2558234	9008234	Black	Plastic / Thumb	Regular	48 / 480



Heavy Duty Plastic Cutter, 3/4" Blade

This heavier plastic construction cutter is available in three color options and arrives in easy to setup counter-top display.

PART#	ADD YOUR NAME & LOGO PART #	COLOUR	SHEATH/ LOCK	BLADE GRADE	BOX/ CASE
2558806	9008806	Red	Plastic / Thumb	Regular	48 / 480
2558807	9008807	Yellow	Plastic / Thumb	Regular	48 / 480
2558808	9008808	Blue	Plastic / Thumb	Regular	48 / 480



Heavy Duty Plastic Cutter w/ Metal Reinforced Head, 3/4" Blade

This heavy duty plastic cutter features metal reinforced sheath for durability.

RETAIL PART#	PART#	ADD YOUR NAME & LOGO PART#	COLOUR	SHEATH/ LOCK	BLADE GRADE	BOX/ CASE	
N/A	2558066	9008066	Red	Plastic / Thumb	Regular	24 / 240	
N/A	2558067	9008067	Blue	Plastic / Thumb	Regular	24 / 240	
<input type="checkbox"/>	2568068	2558068	9008068	Yellow	Plastic / Thumb	Regular	24 / 240



Plastic Cutters, 3/8" Regular Blade

This plastic cutter supports 3/8" blades and is available in two colour options.

BULK	PART#	COLOUR	SHEATH/ LOCK	BOX/ CASE
	2558129	Yellow	Plastic / Thumb	60 / 120
	2558130	Blue	Plastic / Thumb	60 / 120



Boss Products

Sizes are approximate. Specifications subject to change without notice.



Ergo Grip Cutter, 3/4" Industrial Blade

This heavier plastic construction cutter includes rubber elements to ensure the best grip possible. Available in a double-lock switch and knob-lock option.



BULK	PACKAGED	ADD YOUR NAME & LOGO		
PART#	PART#	PART#	SHEATH/LOCK	BOX/CASE
<input type="checkbox"/>	548687	568687	9008687	Auto Lock/Double Locking 10/100
<input type="checkbox"/>	548688	568688	9008688	Knob Lock/Oversized Knob 10/100

Comfort Grip Cutter, 3/4" Industrial Blade

The heavier plastic construction is formed to fit the hand to provide ergonomic support and comfort. Available in a double-lock switch and knob-lock option.



BULK	PACKAGED		
PART#	PART#	SHEATH/LOCK	BOX/CASE
<input type="checkbox"/>	546750	556750	Comfort Grip Knob Lock/Oversized Knob 10/100

Heavy Duty Knob Lock Cutter, 3/4" Industrial Blade

This heavier plastic construction cutter features a 2 blade storage compartment.



BULK	PACKAGED		
PART#	PACK#	SHEATH/LOCK	BOX/CASE
<input type="checkbox"/>	2550425	2560425	HD Plastic 2 Blade Storage/Knob Lock 10/100

Ergonomic Serrated Blade Cutter, 3/4" H.D. Blade 6mm Thickness

This ergonomic cutter supports serrated blades for tougher jobs. The metal reinforced head also improves durability and prevents damage.



PACKAGED		
PART#	SHEATH/LOCK	BOX/CASE
2562600	Ergo Grip Serrated Blade/ Auto Lock	10/60

Safety Cutter, 2 Notch Utility Blade

This safety cutter fully retracts. It comes in a retail package.



PACKAGED		
PART#	SHEATH/LOCK	BOX/CASE
550460	Comfort Safety Cutter/ Metal Reinforced	12/24

Replacement Safety Utility Blade For 550460 - 0.6mm Thickness



PART#	PACK SIZE
2554407	10 pack



Utility Grade - 6/Box

- Coated: Nylon coated blade for maximum weather protection
- Armor housing
- Rivets: 3 end rivets
- Stops: Two well positioned stops for easy use



NON-CUSTOM PRINTED	CUSTOM PRINTED				
PART#	PART#	LENGTH	GRADUATION	WIDTH	HOOK
38220	938220	25'	Imperial/Metric	1"	Standard
38120	938120	16'	Imperial/Metric	1"	Standard

Professional Grade - 12/Box

- Coated: Nylon coated blade for maximum weather protection (38450 - Yellow matte coated black)
- Armor: Coated with rubber for comfort and drop protection
- Rivets: 3 end rivets for extended life (38450 has 4 rivets)
- Stops: Two well positioned stops for easy use
- Heavy Duty Blade: 30% thicker blade for long reach & durability. Tough, fast retracting spring system



NON-CUSTOM PRINTED	CUSTOM PRINTED				
PART#	PART#	LENGTH	GRADUATION	WIDTH	HOOK
38316	938316	16'/5m	Imperial/Metric	1"	Standard
38325	938325	25'/7.5m	Imperial/Metric	1"	Standard
38425	938425	25'	Imperial	1"	Standard
38475	938475	25'	Imperial/Double Sided	1"	Magnetic*
38450	938450	25'/7.5m	Imperial	1-1/4"	Standard

*Grab Hold: Magnetic double hooked for easy measuring

Extra Long - 12/Box

- Compact design: Excellent case design offering increased comfort.
- Ultra durable: Impact resistant case. "Rubber Infused" outside armor.
- 30% Thicker blade triple durability
- Extra long stand out



NON-CUSTOM PRINTED	CUSTOM PRINTED				
PART#	PART#	LENGTH	GRADUATION	WIDTH	HOOK
38480	938480	33'	Imperial/Metric	1"	Double Magnet

Sizes are approximate. Specifications subject to change without notice.





Premium

- ABS case with UV chrome and rubber jacket
- High performance spring
- 9' Long extra stand out
- 60% Thicker blade

NON-CUSTOM PRINTED	CUSTOM PRINTED					
PART#	PART#	LENGTH	GRADUATION	WIDTH	HOOK	Per Box
38525	93525	6'	Imperial/Metric	1"	Double Magnet	12
38550	938550	25'	Imperial/Metric	1"	Double Magnet	6

Heavy Duty SK2 - 3/4" Blade 0.5mm Thickness

- Sk2 + CR formulation means it stays sharper, longer
- Double honed edge for maximum sharpness



ADD YOUR NAME & LOGO	CUSTOM	BULK	PACKAGED	
	PART#	PART#	PART#	PACK SIZE
<input type="checkbox"/>	9555010	2555010	2565010	10 Pack
<input type="checkbox"/>	N/A	2555050	2565050	50 Pack



Heavy Duty Hi Carbon - 3/4" Blade 0.5mm Thickness

- SAE 1125 stress proof steel, honed



	BULK	PACKAGED		
	PART#	PART#	PACK SIZE	CUTTING EDGES
<input type="checkbox"/>	2554403	2564403	10 Pack	8
<input type="checkbox"/>	2554433	2564433	50 Pack	8



Regular Blades - 3/4" Blade 0.5mm Thickness



PART#	PACK SIZE	CUTTING EDGES
2554003	10 pack	8
2554033	50 pack	8



Sizes are approximate. Specifications subject to change without notice.

Heavy Duty SK2 Serrated - 3/4" Blade 0.6mm Thickness

- Sk2 + CR formulation means it stays sharper, longer
- Double honed edge for maximum sharpness

ADD YOUR NAME & LOGO	CUSTOM	BULK	PACKAGED	
	PART#	PART#	PART#	PACK SIZE
	N/A	2554303	2564303	5 Pack
	9554333	2554333	2564333	45 Pack



2 Notch Safety Utility Blade - 0.6mm Thickness

PART#	PACKAGED PART#	PACK SIZE
2554405	2564405	10 pack



Single Edge Razor Blade

PART#	PACK SIZE
2554404	10 pack



Standard Carpenter Pencils

15mm carpenter pencils are available in 7 colors.

NON-CUSTOM PRINTED	ADD YOUR NAME & LOGO	PART#	PART#	COLOUR	LEAD	BOX/CASE
		33810	900810	Yellow	Medium	60 /1200
		33820	900820	Red	Medium	60 /1200
		33830	900830	Blue	Medium	60 /1200
		33840	900840	Orange	Medium	60 /1200
		33850	900850	White	Medium	60 /1200
		33860	900860	Dark Blue	Medium	60 /1200
		33870	900870	Black	Medium	60 /1200



Carpenter Pencil Accessories

PART#	DESCRIPTION	BOX
33788	Pro Carpenter Pencil Sharpener	50



Sizes are approximate. Specifications subject to change without notice.



Padlocks

- Double locking mechanism
- Hardened steel shackle, chrome plated
- Solid brass case
- Anti-pick mushroom pins
- Stainless steel & hardened spring for any climate

PART #	TYPE	PACK QTY.	SIZE (MM)	A (MM)	B (MM)	C (MM)	D (MM)	E (MM)	F (MM)	LOCKING	PINS
2251525	KD	1	25 x 14	25	24.5	14.1	4	12.7	11.9	Single	4
2251526	KA	2									
2251530	KD	1	30 x 20	30	27.5	17.5	4.8	15.9	12.8	Double	4
2251531	KA	2									
2251540	KD	1	40 x 23	40	33	23	6.35	21.6	14.5	Double	5
2251541	KA	2									
2251550	KD	1	50 x 30	50	40.4	29	7.9	27.5	16.8	Double	5
2251551	KA	2									
2251560	KD	1	60 x 33	60	45.4	32.9	9.5	35.8	19.1	Double	5
2251561	KA	2									
2251740	KD	1	40 x 63	40	33	63	6.35	21.6	14.6	Double	4
2251741	KA	2									
2251840	KD	1	40 x 100	40	33	100	6.35	21.6	14.6	Double	4
2251841	KA	2									
2251850	KD	1	50 x 75	50	40.4	75	7.9	27.5	16.8	Double	5
2251851	KA	2									

KD = Keyed Different KA = Keyed Alike

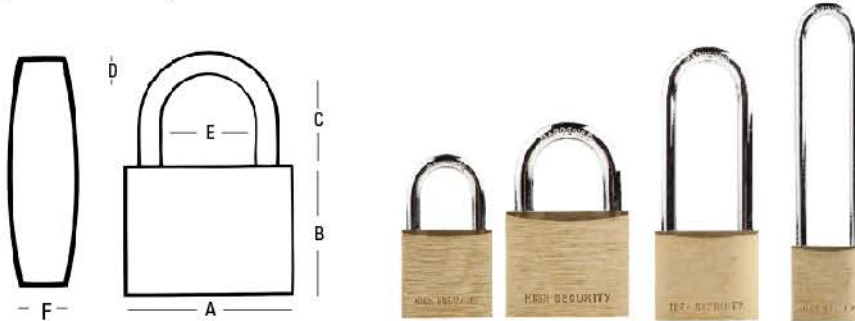

Waterproof Padlocks - 1 / Package

PART#	DESCRIPTION
2253540	40mm Standard Shackle
2253541	40mm Long Shackle

Sizes are approximate. Specifications subject to change without notice.



Boss Products





CUSTOMIZED PRODUCTS

Customized items create exceptionally long-lasting advertising opportunities at a low cost. Let Dynaline help your business achieve the exposure you want.

BOSS Product part numbers that are available for customization are marked with "Customized"

Contact our Customer Service for pricing and availability today

CUSTOMER GUIDELINES

- Provide us with your logo in AI, EPS, PDF or TIFF (300dpi) including any brand guidelines with pantone colors if applicable.

- A signed approval form (provided by Dynaline's Customer Service Team) is required before the order will be moved into production.

- Custom printing can work with multiple colors however, gradients (specifically darker gradients) are not guaranteed to appear accurate in the final product. Solid colors are preferred.

- A handling fee of \$0.05/unit will be charged for double-sided printing.

AVAILABLE ITEMS FOR CUSTOMIZATION



Bit Bars



Cutters and Blades



Driver Bit Set



Tape Measures



Carpenter Pencils

Sizes are approximate. Specifications subject to change without notice.

Legend: □ 12x24 □ 24x24 □ Plan-0-Gram □ Rack/End Cap ○○○ Other



Boss Products





TRAILER AND TOWING



A		In-Line Adapter - 4 Way	153
Adjustable 3-Position Lunette Ring	149	Internal Thread Trailer Balls	134
Adjustable Ball Mounts	144	Internal Thread Trailer Balls	135
Adjustable Brackets	136	J	
Adjustable Double Ball Mount	144	Jack Rack	133
Adjustable Trailer Couplers	136	Jack Replacement Parts And Accessories	158
A-Frame Trailer Couplers	136	L	
B		Levelling Scissor Jacks	158
Aluminum Document Holder	149	Lifter Coupler Handle	136
Ball Mount Kits	141	Long Shank External Thread Trailer Balls	134
Ball Mount Rack	133	M	
Bent Pull Pin with Sleeve	138	Merchandiser - Trailer Balls	131
Blade 7 Way Tester With LEDs	153	Merchandiser - Trailer Couplers	131
Blade Plug -7 Way	151	Mount Fixed Lunette Ring	149
Breakaway Switch With Lanyard	153	Mounting Bracket	151
C		Mounting Lunette Ring - 4-Hole	148
Channel Trailer Couplers	136	Mud Flaps	159
Class 1 Ball Mounts	140	P	
Class 3 - 4 Ball Mounts	140	Pintle Hooks	148
Clevis Ball Mount	143	Pintle Mounts	146
Combination Pintle Hooks	148	Plastic Document Holders	149
Coupler Lock	137	Plug - 7 Way	151
Coupler Lock & Receiving Set	137	Plug - 7 Way	152
D		Plug 7 Way - Heavy Duty	152
Dual Hitch Extension	146	Power Jack	154
E		R	
External Thread Trailer Balls	134	Receiver Lock Pins	137
External Thread Trailer Balls	135	Receiver Pull Pins	138
Extra Lift External Thread Trailer Balls	134	Receiver Tubes	147
EZ-Clips	138	Reducer Sleeve Set	146
F		Round 6 Way Plug & Socket - 6 Way	150
Fifth Wheel King Pin Stabilizer	145	Round Plug & Socket - 4 Pole	150
Flat Connector - 2 Way	150	Round Shank - Reversible	142
Flat Connector - 4 Way	153	Round Shank - Triple	142
Flat Connector - 5 Pole	150	Round Tube Mount Jack	156
Flat Connectors - 5 Pole	150	Round Tube Swivel Bracket Mount Jacks	156
Flat Loop Trailer Connector - 4 Pole	150	RV Bumper Receiver Adapter	147
Flat Tester With LEDs - 4 & 5 Way	153	S	
Flat Tester With LEDs - 4 Way	153	Scissor Jack Drill Adapter	158
Forged Steel Ball Mounts	141	Shackle Ball Mounts	143
H		Side Wind with Wheel	155
H.D. Trailer & RV Wheel Chock	139	Side Wind without Wheel	155
HD Polyfoam Wheel Chock	159	Side Wind, Round Tube Mount	156
Heavy Duty External Thread Trailer Balls	134	Side Wind, Round Tube Mount	156
Hitch Adapters	147	Side Wind, Square Tube Mount	157
Hitch Box Extension	146	Socket - 7 Way	151
I		Socket - 7 Way	151



Socket 6 Way, 4 Way Plug With LEDs	152
Socket 7 Way - Heavy Duty	152
Socket 7 Way / 4-Way Plug Set	151
Socket 7 Way Led & 4-Way Plug With LEDs	152
Sockets - 7 Way	152
Spring Latches	139
Square Drop Shank	142
Square Drop Shank	144
Square Shanks	143
Square Straight Shank	142
Square Tube "Drop Legs" Jack	157
Square Tube "Drop Legs" Jacks	158
Square Tube Trailer Jack	157
Step Bumper Receiver	146
Super Duty Steel Ball Mounts	141
Swing-Way Jacks	154
T	
Top Wind with Wheel	155
Top Wind without Base or Wheel	155
Top Wind, Square Tube Mount	157
Trailer & Towing Plan-O-Gram	131
Trailer & Towing Plan-O-Grams	132
Trailer Ball Reducer Bushings	135
Trailer Ball Replacement Holder	135
Trailer Connector Adapters	153
Trailer Coupler Repair Kits	136
Trailer Dolly	145
Trailer Hitch Cover	145
Trailer Lock Kit	137
W	
Wheel Chocks	159
Wheel Chocks	159
Wheel Chocks	159
Wheel Locks	139





Trailer and Towing



Your Trusted Source.

Dynaline Trailer and Towing Merchandisers

Dynaline offers merchandisers for almost every product. Merchandisers keep your stock organized, visible and easy to shop.



00024 Compatible

Trailer Balls Merchandiser

PART#	CONTENTS
00208	Trailer Balls Display Board Only , 12" x 24"
00208K	Full Trailer Balls Merchandiser. Includes 00208 display board, 12 pegs (80004) and products.

Full product breakdown on page 14



00024 Compatible

Trailer Couplers Merchandiser

PART#	CONTENTS
00215	Trailer Couplers Display Board Only , 24" x 24"
00215K	Full Trailer Couplers Merchandiser. Includes 00215 display board, 10 pegs (80004) and products.

Full product breakdown on page 15



Trailer & Towing Plan-O-Gram 72"

PART#	CONTENTS
00057	Trailer & Towing Backdrop Only , 48" x 72"
00057K	Full Trailer & Towing Plan-O-Gram. Includes 00057 and content.

Full product breakdown on page 16

Pictures are not to scale. Sizes are approximate. Specifications subject to change without notice.





Trailer & Towing Plan-O-Gram 48"

PART#	CONTENTS
01041	Trailer & Towing Backdrop Only , 48" x 48"
01041K	Full Trailer & Towing Plan-O-Gram . Includes 01041 and contents listed below:

i Full product breakdown on page 17

Trailer & Towing 48" x 72" Plan-O-Gram

PART#	CONTENTS
01046	Trailer & Towing Backdrop Only , 48" x 72"
01046K	Full Trailer & Towing Plan-O-Gram . Includes 01046 and contents listed below:

i Full product breakdown on page 18



Trailer & Towing 96" x 72" Plan-O-Gram

PART#	CONTENTS
01045	Trailer & Towing Backdrop Only , 96" x 72"
01045K	Full Trailer & Towing Plan-O-Gram . Includes 01045 and contents listed below

i Full product breakdown on page 19

Pictures are not scale. Sizes are approximate. Specifications subject to change without notice.

Legend: 12x24 24x24 Plan-O-Gram Rack/End Cap Other





Ball Mount Rack

PART#	CONTENTS
00210	Ball Mount Rack Only , 48" x 15" x 10"
00210K	Full Ball Mount Rack Merchandiser. Includes the display and an assortment of our most popular ball mounts and receivers.

Full product breakdown on page 20

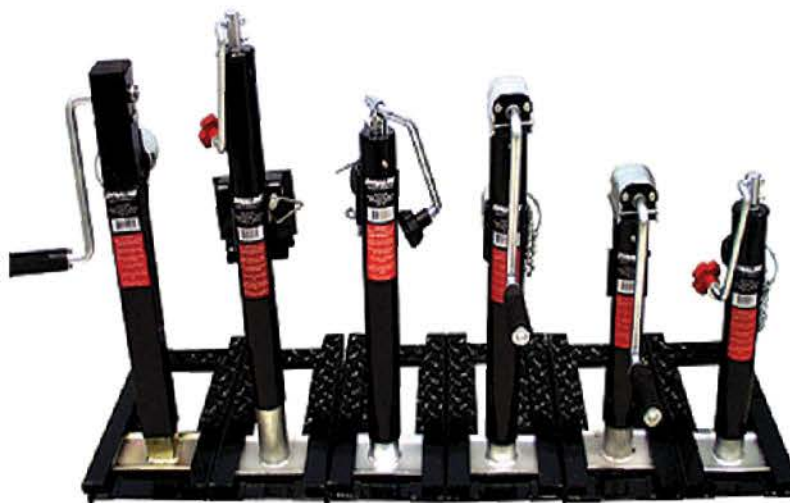

Jack Rack

Jack Rack Merchandiser can be placed on floor or bottom of a gondola shelf. Fits regular 4 ft. Gondola Shelf, 18" deep.

PART#	CONTENTS
00637	Jack Stand Bracket Only , 1 piece display (bolts not included)
00637K	Full Jack Rack Merchandiser. Includes 00637 Jack Rack for Gondola shelf, labels and products below:

Full product breakdown on page 20

Pictures are not to scale. Sizes are approximate. Specifications subject to change without notice.





Internal Thread Trailer Balls

Solid steel. Bright chrome plated finish. Meets or exceeds VESC V-5 safety specifications.

PART#	BALL DIAMETER	SHANK DIAMETER	SHANK LENGTH	GROSS LOAD RATING
11148	1-7/8"	3/4"	2"	2,000 lb
11149	2"	3/4"	2"	3,500 lb

External Thread Trailer Balls

Solid steel. Bright chrome plated finish. Meets or exceeds VESC V-5 safety specifications.

PART#	BALL DIAMETER	SHANK DIAMETER	SHANK LENGTH	GROSS LOAD RATING
11147	1-7/8"	1"	2-5/8"	3,500 lb
11151	1-7/8"	3/4"	1-1/2"	2,000 lb
11152	2"	3/4"	2"	3,500 lb
11154	2"	1"	2-5/8"	5,000 lb
11155	2-5/16"	1-1/4"	2-5/8"	10,000 lb
11154	2-5/16"	1"	2-5/8"	5,000 lb
11155H	2-5/16"	1-1/4"	2-1/4"	14,000 lb
11155X	2-5/16"	1-1/4"	2"	12,000 lb
11258	2"	1-1/4"	2-1/4"	8,000 lb

Long Shank External Thread Trailer Balls

Solid steel. Bright chrome plated finish. Meets or exceeds VESC V-5 safety specifications.

PART#	BALL DIAMETER	SHANK DIAMETER	SHANK LENGTH	GROSS LOAD RATING
11251	1-7/8"	3/4"	3-1/4"	2,000 lb
11252	2"	3/4"	3-1/4"	3,500 lb
11257	2"	1"	3-1/4"	5,000 lb
11263	2-5/16"	1"	3"	6,000 lb

Extra Lift External Thread Trailer Balls

Solid steel. Bright chrome plated finish. Meets or exceeds VESC V-5 safety specifications.

PART#	BALL DIAMETER	SHANK DIAMETER	SHANK LENGTH	RISE HEIGHT	GROSS LOAD RATING
11253	2"	1"	2-5/8"	1"	3,500 lb
11255	2-5/16"	1-1/4"	2-1/4"	1"	7,000 lb

Heavy Duty External Thread Trailer Balls

Solid steel. Black powder coated finish. Meets or exceeds VESC V-5 safety specifications.

PART#	BALL DIAMETER	SHANK DIAMETER	SHANK LENGTH	RISE HEIGHT	GROSS LOAD RATING
11259	2-5/16"	1-1/4"	2-5/8"	Standard	30,000 lb
11260	2-5/16"	1-1/4"	2-5/8"	1"	30,000 lb
11261	2-5/16"	1-1/4"	2-1/2"	2"	30,000 lb

Pictures are not scale. Sizes are approximate. Specifications subject to change without notice.



Trailer and Towing



Internal Thread Trailer Balls - Retail Packaged

Solid steel. Bright chrome plated finish. Meets or exceeds VESC V-5 safety specifications.



PART#	BALL DIAMETER	SHANK DIAMETER	SHANK LENGTH	GROSS LOAD RATING
11148P	1-7/8"	3/4"	1-3/4"	2,000 lb
11149P	2"	3/4"	1-3/4"	3,500 lb



External Thread Trailer Balls - Retail Packaged

Solid steel. Bright chrome plated finish. Meets or exceeds VESC V-5 safety specifications.

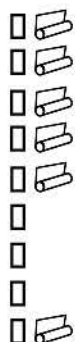

PART#	BALL DIAMETER	SHANK DIAMETER	SHANK LENGTH	GROSS LOAD RATING
11147P	1-7/8"	1"	2-5/8"	3,500 lb
11151P	1-7/8"	3/4"	1-1/2"	2,000 lb
11152P	2"	3/4"	1-1/2"	3,500 lb
11153P	2"	1"	2-5/8"	5,000 lb
11154P	2-5/16"	1"	2-5/8"	5,000 lb
11155P	2-5/16"	1-1/4"	2-5/8"	10,000 lb
11155HP	2-5/16"	1-1/4"	2-1/4"	14,000 lb
11155XP	2-5/16"	1-1/4"	2"	12,000 lb
11251P	1-7/8"	3/4"	3-1/4"	2,000 lb
11252P	2"	3/4"	3-1/4"	3,500 lb



Trailer Ball Replacement Holder

Black plastic with generic label.

PART#	DESCRIPTION	FITS
TB001	Small - 6.89" x 2.28" x 2.52"	11148, 11149, 11151, 11152 (See previous page)
TB002	Large - 7.36" x 2.64" x 2.99"	11147, 11153, 11154, 11155, 11155H, 11155X (See previous page)



Trailer Ball Reducer Bushings

Clamshell packaged.



PART#	DESCRIPTION
11170	Trailer Ball Reducer Bushing, 1" to 3/4"
11171	Trailer Ball Reducer Bushing, 1-1/4" to 1"



Trailer and Towing

Pictures are not to scale. Sizes are approximate. Specifications subject to change without notice.





Channel Trailer Couplers

Features large trigger-action latch designed for ease of operation. Zinc Plated Finish. Stamped steel construction. Easy to install. S.A.E. Class 2



PART#	BALL SIZE	CHANNEL SIZE	GROSS LOAD RATING
11156	1-7/8"	2"	2,000 lb
11157	1-7/8"	2-1/2"	2,000 lb
11158	1-7/8"	3"	2,000 lb
11159	2"	2-1/2"	3,500 lb
11159N	2"	2"	3,500 lb
11160	2"	3"	3,500 lb



A-Frame Trailer Couplers

Features large trigger-action latch designed for ease of operation. Zinc plated finish. Stamped steel construction. Easy to install

PART#	BALL SIZE	TYPE	GROSS LOAD RATING
11161	2"	Standard	5,000 lb
11162	2-5/16"	Standard	10,000 lb



Trailer Coupler Repair Kits

Repair kit available for both 1-7/8" and 2" ball channel couplers. Zinc plate finish.

PART#	DESCRIPTION
11163	For 1-7/8" Ball Channel Coupler
11164	For 2" Ball Channel Coupler



Lifter Coupler Handle

For easy lifting of trailer tongue on small trailers (coupler not included).

PART#	DESCRIPTION
11870	Zinc plated with rubber coating on the handle. Handle attaches to coupler mounting bolts.



Adjustable Trailer Couplers

Carbon steel.

PART#	BALL SIZE	TONGUE WEIGHT	MAX. GROSS LOAD	OVERALL DIMENSIONS
11864	2"	800 lb	8,000 lb	9" L x 5-1/2" W
11865	2-5/16"	1,400 lb	14,000 lb	9-1/4" L x 5-3/4" W



Adjustable Brackets

Designed for adjustable couplers.

PART#	DESCRIPTION	HOLE DIAMETER	CAPACITY	OUTSIDE WIDTH	INSIDE WIDTH	OVERALL LENGTH
11866	12 hole (6 pairs)	5/8"	16,000 lb	3-5/8"	3"	11-1/2"
11867	8 hole (4 pairs)	5/8"	16,000 lb	3-5/8"	3"	7-1/2"

Pictures are not scale. Sizes are approximate. Specifications subject to change without notice.



Trailer and Towing





Coupler Lock

PART#	DESCRIPTION	DIAMETER	USABLE LENGTH
 66276	Fits all latch-type couplers. Two keys supplied. Yellow dichromate finish Clamshell packaging.	1/4"	7/8" (closed)



Coupler Lock & Receiving Set

PART#	DESCRIPTION	RECEIVER DIAMETER	USABLE LENGTH	COUPLER LOCK	USABLE LENGTH
 66277	Fits most receiver hitches and latch-type couplers. Same key fits both locks. Chrome plated Clamshell packaging.	5/8"	2-3/4"	1/4"	1"



Receiver Lock Pins

Two sizes to fit most receiver-type hitches. Two keys supplied. Bright chrome plated pin. Black enamel painted lock body.

PART#	DIAMETER	USABLE LENGTH	TENSILE STRENGTH
 66274	1/2"	2-1/2"	5,500 lb
66275	5/8"	3"	8,800 lb



Hitch Lock

Chrome plated, weather proof cap. Clamshell packaged.

PART#	TYPE	DIAMETER	USABLE LENGTH
65091	Sleeved Barrel	5/8" or 1/2"	2-1/2"



Universal Trailer Coupler Locks

Bent at the perfect angle for easy removal. Made from oil tempered spring wire. Clear zinc plated finish. Features a locking bar with 6 locking positions.

PART#	DESCRIPTION
 65085	Light Duty. Fits 1-7/8", 2" and 2-5/16" Couplers.
65086	Heavy Duty . Fits 1-7/8", 2" and 2-5/16" Couplers.



Trailer Lock Kit

Spring loaded bolt can be locked in the open position. Zinc plated bolt housing and keeper. Turning lever allows the bolt to close under spring pressure.

PART#	DESCRIPTION	CONTENTS
 65087	Keyed alike	Light duty Universal Trailer Coupler Lock , Brass Coupler lock , Dual bent Pin Hitch lock (fits 5/8 and 1/2 receivers)



Pictures are not to scale. Sizes are approximate. Specifications subject to change without notice.





Trailer and Towing

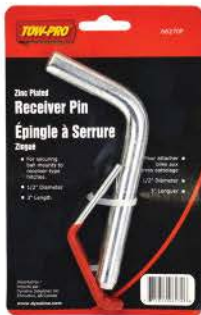

Receiver Pull Pins

For securing ball mounts to receiver-type hitches. Supplied with EZ clip.

PART#	MATERIAL	DIAMETER	USABLE LENGTH	CLIP TYPE
66267	Stainless Steel - Won't Rust!	1/2"	3"	vinyl coated grip EZ clip
66268	Stainless Steel - Won't Rust!	5/8"	3"	vinyl coated grip EZ clip
102281	High carbon steel, zinc plated.	3/8"	3"	standard EZ clip
102282	High carbon steel, zinc plated.	1/2"	2-1/2"	standard EZ clip
66270	High carbon steel, zinc plated.	1/2"	3"	vinyl coated grip EZ clip
102284	High carbon steel, zinc plated.	1/2"	4"	standard EZ clip
102285	High carbon steel, zinc plated.	1/2"	5"	standard EZ clip
66270P	As 66270 above, carded.	1/2"	3"	vinyl coated grip EZ clip
66271	High carbon steel, zinc plated.	5/8"	3"	vinyl coated grip EZ clip
102287	High carbon steel, zinc plated.	5/8"	4"	standard EZ clip
102288	High carbon steel, zinc plated.	5/8"	5"	standard EZ clip
102289	High carbon steel, zinc plated.	3/4"	3-1/2"	standard EZ clip
102290	High carbon steel, zinc plated.	3/4"	4-1/2"	standard EZ clip
102291	High carbon steel, zinc plated.	3/4"	5"	standard EZ clip
66271P	As 66271 above, carded.	5/8"	3"	vinyl coated grip EZ clip
66272	High carbon steel, zinc plated.	5/8"	3-1/2"	vinyl coated grip EZ clip

EZ-Clips

Bent at the perfect angle for easy removal. Made from oil tempered spring wire. Clear zinc plated finish.



PART#	DESCRIPTION	WIRE DIAMETER	PKG. QTY.
66265	Clear zinc plated finish.	0.148"	25
66266	Vinyl coated non-slip grip.	0.148"	10
96266	Vinyl coated non-slip grip.	0.148"	2 (Blister Pack)

Bent Pull Pin with Sleeve

Chrome plated, weather proof cap. Clamshell packaged.



PART#	DESCRIPTION
66273	Fits 1/2" & 5/8", C-1018 mild steel material. Zinc plated finish comes with a red vinyl coated grip E-Z clip.

Pictures are not scale. Sizes are approximate. Specifications subject to change without notice.

H.D. Trailer & RV Wheel Chock

Made of heavy duty steel construction with corrosion resistant zinc plating. Fits tire spacing from 3" to 10". Includes a ratchet wrench (19mm) for easy installation and a padlock for extra security. Raised ribs on arms for increased traction.



PART#	SIZE
11989	15" x 9.5" x 10"

Wheel Locks

Adjustable slide-lock for wheels. Fits multiple tire sizes. Weather proof locks with 2 keys.



PART#	DESCRIPTION	PACKAGING
 65088	Heavy Duty. Fits 7" to 11" width tires	Double blister

PART#	DESCRIPTION	PACKAGING
65089	Super Heavy Duty. Fits 7" to 11" width tires	Colour box



PART#	DESCRIPTION	PACKAGING
65090	Extreme Heavy Duty. Fits 13" to 16" Rims. Fits tires up to 28". Diameter X 9" width	Colour box



Spring Latches

Spring loaded bolt can be locked in the open position. Zinc plated bolt housing and keeper. Turning lever allows the bolt to close under spring pressure.

PART#	PIN DIAMETER	HANDLE TYPE	BRACKET LENGTH	BRACKET WIDTH	OVERALL LENGTH	MOUNTING HOLE DIAMETER
23057	7/16"	Loop	3-3/8"	1-1/2"	7-1/4"	3/16"
23058	1/2"	4" L shape	3-1/8"	1-3/4"	5-1/2"	1/4"



Trailer and Towing

Pictures are not to scale. Sizes are approximate. Specifications subject to change without notice.





Class 1 Ball Mounts

Robotic welded, solid shank. Fits 1-1/4" Class 1 receiver tubes. Black powder coated finish.



PART#	FINISH	CLASS	TW (LB)	GTW (LB)	HOLE	DROP	RISE	LENGTH
11670	Black	1	200 lb	2,000 lb	3/4"	1-1/4"	5/8"	6-3/4"
11671	Black	1	200 lb	2,000 lb	3/4"	2-3/4"	2-1/8"	7"
11672	Black	1	200 lb	2,000 lb	3/4"	3-1/2"	3"	9-1/2"



Class 3-4 Ball Mounts

Robotic welded, hollow shank. Fits 2" receivers. Black powder coated & chrome finish.



PART#	FINISH	CLASS	TW (LB)	GTW (LB)	HOLE	DROP	RISE	LENGTH
11600	Black	3	500 lb	5,000 lb	1"	Straight	Straight	10-1/2"
11601	Black	4	600 lb	6,000 lb	1"	2"	3/4"	9"
11602	Black	4	600 lb	6,000 lb	1"	4"	3"	9-1/4"
11603	Black	4	600 lb	6,000 lb	1"	6"	5"	11"
11611	Chrome	4	600 lb	6,000 lb	1"	2"	3/4"	8"
11612	Chrome	4	600 lb	6,000 lb	1"	4"	3"	8-3/4"

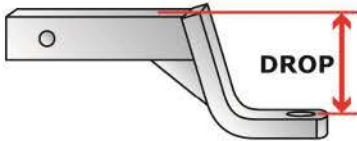

DROP

The distance from the top of the shank to the top of the ball platform

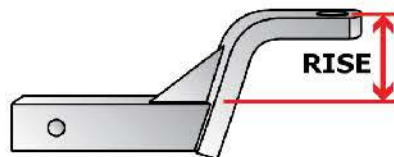

RISE

The distance from the top of the shank to the top of the ball platform

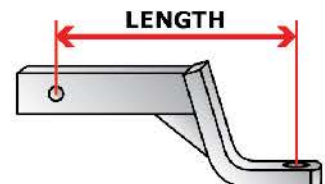

LENGTH

The distance from the center of the ball hole to the center of the pin hole

Pictures are not scale. Sizes are approximate. Specifications subject to change without notice.



Trailer and Towing

Class 4 Forged Steel Ball Mounts

Solid one piece, forged ball mount. Fits 2" receivers. Black powder coated finish.

PART#	FINISH	CLASS	TW (LB)	GTW (LB)	HOLE	DROP	RISE	LENGTH
11586	Black	4	1,000 lb	10,000 lb	1-1/4"	2"	1"	8-3/8"
11587	Black	4	1,000 lb	10,000 lb	1-1/4"	4"	3"	9-1/2"
11588	Black	4	1,000 lb	10,000 lb	1-1/4"	6"	5"	11"



Class 5 Forged Steel Ball Mounts

Solid one piece forged ball mount. Fits 2" receivers. Black powder coated finish.

PART#	FINISH	CLASS	TW (LB)	GTW (LB)	HOLE	DROP	RISE	LENGTH
11686	Black	5	1,200 lb	12,000 lb	1-1/4"	2"	1"	8-3/8"
11687	Black	5	1,200 lb	12,000 lb	1-1/4"	4"	3"	9-1/2"
11688	Black	5	1,200 lb	12,000 lb	1-1/4"	6"	5"	11"



Super Duty Steel Ball Mounts

Robotic welded, hollow shank. Fits 2-1/2" receivers. Black powder coated finish.



PART#	FINISH	CLASS	TW (LB)	GTW (LB)	HOLE	DROP	RISE	LENGTH
11690	Black	4	1,000 lb	10,000 lb	1-1/4"	3"	1-1/2"	9-3/4"
11691	Black	4	1,000 lb	10,000 lb	1-1/4"	5"	3-1/2"	10"
11692	Black	4	1,000 lb	10,000 lb	1-1/4"	8"	6-1/2"	10-1/2"



Ball Mount Kits

Includes ball mount, welded trailer ball and pull pin. Fits 2" receivers.



PART#	FINISH	CLASS	BALL	TW (LB)	GTW (LB)	DROP	RISE	LENGTH
11590	Black	4	1-7/8"	500 lb	5,000 lb	2"	1"	8-1/4"
11591	Black	4	2"	600 lb	6,000 lb	2"	1"	8-1/4"
11592	Black	4	2-5/16"	600 lb	6,000 lb	2"	1"	8-1/4"
11641	Chrome	4	2"	600 lb	6,000 lb	2"	1"	8-1/4"



Pictures are not to scale. Sizes are approximate. Specifications subject to change without notice.



MULTIPLE BALL MOUNTS - WELDED BALLS

Solid round shank with welded balls. Fits standard 2" square receivers.
No need to remove when changing - **just pull the pin and turn!**



Trailer and Towing



Round Shank - Triple

Solid round shank with welded balls. Fits standard 2" square receivers.
No need to remove when changing - just pull the pin and turn!

PART#	FINISH	CLASS	BALL	TW (LB)	GTW (LB)	DROP	RISE	LENGTH
11648	Black	3-4	1-7/8"	350 lb	3500 lb	Straight	Straight	7-1/2"
			2"	600 lb	6,000 lb			
			2-5/16"	1000 lb	10,000 lb			



Round Shank - Reversible

Solid round shank with welded balls. Fits standard 2" square receivers. No need to remove when changing - just pull the pin and turn!

PART#	FINISH	CLASS	BALL	TW (LB)	GTW (LB)	DROP	RISE	LENGTH
11647	Black	3	2"	600 lb	6000 lb	Straight	Straight	7-1/2"
			2-5/16"	1,000 lb	10,000 lb			



11604

Square Straight Shank - Reversible

Straight solid shank with welded balls. Fits 2" receivers.

PART#	FINISH	CLASS	BALL	TW (LB)	GTW (LB)	DROP	RISE	LENGTH
11604	Black	3-4	1-7/8"	350 lb	3500 lb	Straight	Straight	7-1/4"
			2"	600 lb	6,000 lb			
11605	Black	3-4	2"	600 lb	6000 lb	Straight	Straight	7-1/4"
			2-5/16"	1,000 lb	10,000 lb			



11644

Square Drop Shank - Reversible

Drop solid shank with welded balls. Fits 2" receivers.

PART#	FINISH	CLASS	BALL	TW (LB)	GTW (LB)	DROP	RISE	LENGTH
11644	Black	3	1-7/8"	350 lb	3500 lb	2"	3/4"	8"
			2"	600 lb	6,000 lb			
11645	Black	3	2"	600 lb	6000 lb	2"	3/4"	7-1/4"
			2-5/16"	1,000 lb	10,000 lb			

Pictures are not scale. Sizes are approximate. Specifications subject to change without notice.



Square Shank - Triple Ball

Fits 2" receivers, 5/8" hole size.

PART#	DESCRIPTION	FINISH	CLASS	BALL	TW (LB)	GTW (LB)	LENGTH
11607	Solid square shank with welded balls	Black	3-4	1-7/8"	350 lb	3500 lb	8"
				2"	600 lb	6000 lb	8"
				2-5/16"	1,000 lb	10,000 lb	8"
11652	Hollow shank with welded balls	Black	3-4	1-7/8"	200 lb	2,000 lb	8"
				2"	600 lb	6,000 lb	8"
				2-5/16"	1,000 lb	10,000 lb	6-3/4"



11652

Square Shank - Triple Ball with Tow Hook

Fits 2" receivers, 5/8" hole size. Hook load rating capacity 7,500 lbs"

PART#	DESCRIPTION	FINISH	CLASS	BALL	TW (LB)	GTW (LB)	LENGTH
11606	Solid square shank with welded balls & tow hook	Black	3-4	1-7/8"	350 lb	3,500 lb	8"
				2"	600 lb	6,000 lb	8"
				2-5/16"	1,000 lb	10,000 lb	8"



Clevis Ball Mount

Hollow shank. Can be used as a standard ball mount.

PART#	FINISH	TW (LB)	GTW (LB)	TUBE	HOLE	LENGTH
11579	Black	600 lb	6,000 lb	Straight	1"	10"



Shackle (Tow Strap) Ball Mount

For use with recovery straps on pickups and ATVs. Black powder coated finish with zinc plated shackle. Fits 2" receivers.

PART#	FINISH	TW (LB)	GTW (LB)	OVERALL LENGTH	SHANK TYPE	SHACKLE DIAMETER
11693	Black	600 lb	6,000 lb	9-3/8"	Hollow	5/8"
11694	Black	1000 lb	10,000 lb	10"	Solid	3/4"



Trailer and Towing

Pictures are not to scale. Sizes are approximate. Specifications subject to change without notice.



ADJUSTABLE BALL MOUNTS

Black powder coated finish. Perfect for use on tow trailers of various coupler heights. Can be used in the rise or drop position as needed. Two pieces, comes with pull pins & clips.



Adjustable Ball Mounts

Made of Aluminum material. 10,000 lb GTW capacity. 8" drop/rise. 2" aluminum shank, fits 2" receiver. Comes with two trailer balls. Chrome plated finish. Includes two 5/8" pin locks (with 2 keys)

PART#	BALL	TW (LB)	GTW (LB)
11654	2"	800 lb	8,000 lb
	2-5/16"	1,000 lb	10,000 lb

Adjustable Triple Ball Mounts

High grade solid steel for maximum strength. 3-pin design for easy adjustment (pins & clips included). Straight to 6-1/2" maximum drop/rise. 2" x 2" solid shank. Meets S.A.E. J684/V-5.

PART#	CLASS	BALL	TW (LB)	GTW (LB)
11650	3-4	1-7/8"	600 lb	6,000 lb
		2"	1,000 lb	10,000 lb
		2-5/16"	1,000 lb	10,000 lb

Adjustable Ball Mounts (Single Platform)

Black powder coated finish. Perfect for use on tow trailers of various coupler heights. Can be used in the rise or drop position as needed. Fits 2" receiver. Trailer hole size is 1". Pull pin & clip are included.

PART#	FINISH	CLASS	TW (LB)	GTW (LB)	LENGTH	ADJUSTMENT
11595	Black	3	600 lb	6,000 lb	12-1/2"	2" to 7-3/4" drop, up to 6-1/2" rise



Square Drop Shank - Reversible

Drop solid shank with welded balls. Fits 2" receivers.

PART#	FINISH	TW (LB)	GTW (LB)	LENGTH (A)	DROP (B)	HEIGHT (C)
11561	Black	500 lb	5,000 lb	12-1/4"	5"- 9-1/2"	3-3/4"- 8-1/4"

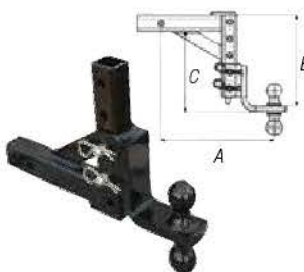

Adjustable Double Ball Mount

Solid steel with 5/8" pin hole. 1-7/8" ball supports up to 2,000 lb; 2" ball supports up to 5,000 lb.

PART#	RECEIVER OPENING	LENGTH (A)	DROP (B)	HEIGHT (C)
11562	2"x2"	13-1/2"	4-4/5"- 10-4/5"	3-3/5" - 9-3/5"



Trailer Hitch Cover

Protects receiver tube from elements and debris. Includes rubber strap that can be fixed to receiver to prevent it from being lost.



PART#	FIT
11792	1-1/4" Receivers
11793	2" Receivers



Trailer and Towing

Fifth Wheel King Pin Stabilizer

Stabilizes motion of unhitched trailer or RV. Threaded hitch cap allows for height adjustment. Includes chain with inserts. Folds for storage. Durable steel construction. King Pin height adjusts from 35" to 55".



PART#	SUPPORT CAPACITY	FOOTPLATE DIMENSIONS	WEIGHT
11794	5,000 lb	5" x 5-1/2"	23 lb



Trailer Dolly

Robust steel construction with black powder coated finish. Rust and corrosion resistant. Features rubberized grip T-handle and 10" pneumatic wheels.



PART#	TRAILER BALL	TONGUE WEIGHT CAPACITY
11795	1-7/8"	600 Lbs

Pictures are not scal Sizes are approximat Specifications subject to change without notic



Pintle Mounts

For 2" receivers. Converts receivers for use with pintle type trailers quickly and easily. Provides mounting for both ball and pintle hooks. Black powder coat finish.

PART#	DESCRIPTION	TW (LB)	GTW (LB)	# OF HOLES	POSITION (PAIRS)
11610	7-3/8" x 5"	2,800 lb	14,000 lb	8	4th
11630	12-1/2" x 5"	2,000 lb	10,000 lb	14	7th



Dual Hitch Extension

Fits 2" receivers.

PART#	FINISH	TW (LB)	GTW (LB)	LENGTH (A)	HEIGHT (B)
11780	Black	400 lb	4,000 lb	12-1/4"	6-1/4"

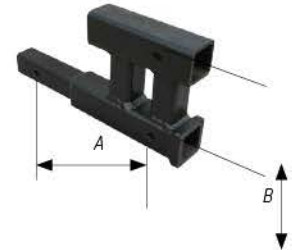

Step Bumper Receiver

Fits 2" receivers.

PART#	FINISH	TW (LB)	GTW (LB)
11782	Black	500 lb	5,000 lb



Hitch Box Extension

Service step. 2" extension only.

PART#	DESCRIPTION	TW (LB)	GTW (LB)
11784	14" x 7" stepping area	400 lb	4,000 lb



Reducer Sleeve Set

Reduces a 3" receiver tube to accept 2-1/2" or 2" shanks. 5/8" hitch pin hole size.

PART#	DESCRIPTION
11790	3" to 2-1/2" or 2" Black powder coated finish. Carbon steel construction.



Pictures are not scale. Sizes are approximate. Specifications subject to change without notice.

Legend: 12x24 24x24 Plan-O-Gram Rack/End Cap Other



Receiver Tubes

Powder coated black finish. Welded. Fits 2" receivers.

PART#	LENGTH
11770	6"
11771	12"
11772	18"
11773	24"



Hitch Adapters

Ideal for cargo carriers and bike carriers. Black powder coated finish. **Not to be used for towing.**

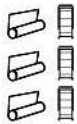

PART#	DESCRIPTION
11785	Decrease receiver opening from 2-1/2" to 2", 5/8" pin, 5" in length.
11786	Decrease receiver opening from 2" to 1-1/4", 5/8" pin hole, 3-1/2" length.
11787	Increase receiver opening from 1-1/4" to 2", GTW 3500 lb
11788	Decrease receiver opening from 2" to 1-1/4", GTW 3500 lb
11789	8-1/2" Length, fits 2" receivers.



11785

RV Bumper Receiver Adapter 2"

Heavy duty adapter for 4x4 RV Bumper.

PART#	DESCRIPTION	TONGUE CAPACITY
11778	Black Power Coated Finish. Accepts 2" cargo carrier tube.	200lbs

- This travel trailer accessories fits 4"- 4" square bumpers (can be mounted upside or down bumper beams)
- For mount 2" shank of bike racks, RV tire carriers, cargo carriers or other accessories, The bumper receiver allows 200 lb tongue weight capacity
- Made of solid steel construction with durable black powder coated finish
- The bumper adapter takes 4 bolts and secures tightly around the travel trailer bumper





Pictures are not to scale. Sizes are approximate. Specifications subject to change without notice.



11618

Pintle Hooks

Solid forged steel construction. Black enamel painted finish. 4-1/4" x 3-1/4" base plate. All bolts are made from heat treated alloy steel.

PART#	CAPACITY	TW (LB)	GTW (LB)
 11618	5 Tons	2,000 lb	10,000 lb
 11620	10 Tons	4,000 lb	20,000 lb
 11619	15 Tons	6,000 lb	30,000 lb
 11621	20 Tons	9,000 lb	40,000 lb
11622	30 Tons	14,000 lb	60,000 lb



11718



Pintle Hooks - Solid Shank

Fits 2" receivers.

PART#	TW (LB)	HOOK CAP. (LB)
11718	2,000 lb	10,000 lb
11719	2,000 lb	20,000 lb
11720	2,000 lb	30,000 lb



Combination Pintle Hooks - Class 5

PART#	BALL SIZE	BALL CAP.(LB)	TW (LB)	GTW (LB)	REPLACEMENT BALL PART #'S
 11616	2"	7,000 lb	3,000 lb	16,000 lb	11632
 11617	2-5/16"	14,000 lb	3,000 lb	16,000 lb	11633



Combination Pintle Hooks Class 5 - 1 Piece, Solid Shank

Solid steel construction. Comes with lock pin on chain and 2" trailer ball. Fits 2" receivers.

PART#	BALL SIZE	BALL CAP.(LB)	TW (LB)	GTW (LB)	SHANK	REPLACEMENT BALL PART #'S
 11715	1-7/8"	2,000 lb	1,200 lb	12,000 lb	2"	11631
 11716	2"	7,000 lb	1,200 lb	12,000 lb	2"	11632
 11717	2-5/16"	12,000 lb	1,200 lb	12,000 lb	2"	11633



4-Hole Mounting Lunette Ring

Forged steel with black powder coated finish.

PART#	DESCRIPTION	TOW RATING
11636	2-1/2" diameter ring with square 6" base plate, 5/8" diameter mounting holes, 4,000 lb. vertical load.	42,000 lb



Trailer and Towing





Mount Fixed Lunette Ring

Forged steel with black powder coated finish.

PART#	DESCRIPTION	TOW RATING
11634	2-1/2" ring diameter, 3-1/4" shank length, 1-1/2" shank diameter	15,000 lb



Adjustable 3-Position Lunette Ring

Forged steel with black powder coated finish.

PART#	DESCRIPTION	TOW RATING
11635	Forged ring 6" outside diameter, 2-3/4" inside diameter, 4-3/8" outside bracket width, 3-5/8" inside bracket width, 1,800 lb. vertical load.	12,000 lb



Plastic Document Holders

Molded from high density polypropylene, weather and impact resistant. Protects documents from damage. Mounts onto machines for easy access. O-Ring sealed. Screw top lid.

PART#	DESCRIPTION
17710	Plastic Holder 2-1/4" diameter x 12-1/2" long
17720	Plastic Holder 2" diameter x 12-1/2" long
17730	Plastic Holder 3-1/4" diameter x 14" long
17731	Tether for plastic holder 17720 and 17730



Aluminum Document Holder

Made from corrosion resistant aluminum. Protects documents from the elements.

PART#	DESCRIPTION
17740	1.5" inside diameter x 9" long
17740-1	Rubber cap replacement for 17740



Pictures are not to scale. Sizes are approximate. Specifications subject to change without notice.





2 Way Flat Connector

PART#	DESCRIPTION
27002	2-pole flat connectors. 12" 18 ga. white & yellow wires.



27004



27006



27008

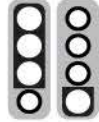

4 Pole Flat Connectors

PART#	DESCRIPTION
27004	4-pole flat wiring harness. 18 ga wire - 12" male, 48" female, 18" ground.
27006	4-pole flat wiring harness. 12" 18 ga wire.
27008	4-way flat wiring harness. 25" 3-wire bonded loop with ground wire. 18 ft male end, 5 ft female end. 5 ft brown extension wire included.

4 Pole Flat Loop Trailer Connector - Heavy Duty

PART#	DESCRIPTION
27010	4-pole flat loop. Heavy duty. 48" 18 ga. wires.

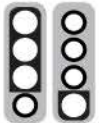

4 Pole Round Plug & Socket

PART#	DESCRIPTION
27015	Die cast, chrome plated housing. Trailer and Vehicle side.



5 Pole Flat Connectors

PART#	DESCRIPTION
27020	Male connector plug. Comes with 48" of 18 gauge wire.
27022	Female connector socket. Comes with 48" of 18 gauge wire.

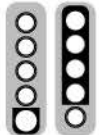

5 Pole Flat Connector- Heavy Duty

PART#	DESCRIPTION
27024	5-pole heavy duty connector loop. 48" 18 ga. wires.

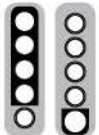

6 Way Round Plug & Socket

PART#	DESCRIPTION
27030	6-way round plug & socket. Heavy duty die cast housing.
27034	6-pole round socket with cover, with heavy duty die cast housing, vehicle side.
27036	6-pole round plug. Heavy duty die cast housing, trailer side.



Pictures are not scale. Sizes are approximate. Specifications subject to change without notice.



Trailer and Towing





Mounting Bracket For 7 Way Trailer Connectors

PART#	DESCRIPTION
 27040	Zinc plated.



7 Way Socket

PART#	DESCRIPTION
 27042	7-way blade socket with cover. Zinc plated metal housing. Vehicle side.



7 Way Blade Plug

PART#	DESCRIPTION
 27044	7-way blade blade plug. Zinc plated metal housing. Trailer side.



7 Way Plug And Socket

PART#	DESCRIPTION
 27046	7-way blade. With cover, ABS housing with red reflector. Trailer and vehicle side.



7 Way Socket

PART#	DESCRIPTION
 27048	7-way blade socket. Plastic housing with red reflector. Vehicle side.



7 Way Plug

PART#	DESCRIPTION
 27050	7-way blade flat plug. Plastic housing. Trailer side.



7 Way Socket / 4-Way Plug Set

PART#	DESCRIPTION
 27052	7-way blade socket with cover. 4-way flat plug & Direct wiring. Vehicle side.



Pictures are not to scale. Sizes are approximate. Specifications subject to change without notice.





Trailer and Towing



7 Way Socket Led & 4-Way Plug With LEDs

PART#	DESCRIPTION
27054	7-way pre-wired blade socket with cover. 4-way flat plug. 6 LED indicator. Vehicle side.
27056	27054 plus Mounting Kit.



7 Way Plug - Heavy Duty

PART#	DESCRIPTION
27060	7-pole round plug. Heavy duty die cast housing. Trailer side.



7 Way Socket - Heavy Duty

PART#	DESCRIPTION
27062	7 pole round socket with cover. Vehicle side.



7 Way Plug

PART#	DESCRIPTION
27064	7-pole round plug. Nylon with fiberglass housing. Trailer side.



7 Way Socket

PART#	DESCRIPTION
27066	7-pole round socket with cover. Nylon with fiberglass housing. Vehicle side.



7 Way Socket - Heavy Duty

PART#	DESCRIPTION
27068	7-pole round heavy duty socket. 3 hole mounting.

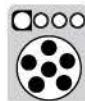

6 Way Socket, 4 Way Plug With LEDs (Adapter)

PART#	DESCRIPTION
27075	#27070 Plus mounting kit.

Pictures are not scale. Sizes are approximate. Specifications subject to change without notice.



4 Way In-Line Adapter

PART#	DESCRIPTION
27076	Trailer Connector Set, 4-way in-line adapter with cover.



Trailer Connector Adapters

PART#	DESCRIPTION
27078	6-way round to 4-way flat.
27080	7-pole round to 4-way flat.
27082	7-way blade to 6-way round. Center pin auxiliary.
27084	7-way blade to 4-way flat.
27086	7-way blade plug to 6-way round socket, 5-way flat, and 4-way flat.
27088	7-pole blade plug to 7-pole round socket. Heavy duty.



4 Way Flat Connector (Adapter)

PART#	DESCRIPTION	CONTENT
27090	Tail Light Adapter. 4 way 3 amp flat connector with cover.	Supplied with 18 gauge bonded wiring.



4 Way Flat Tester With LEDs

PART#	DESCRIPTION
27092	4-way flat tester with 3 LEDs indicator and ring.



4 Way And 5 Way Flat Tester With LEDs

PART#	DESCRIPTION
27093	4-way and 5-way flat tester with 4 LEDs indicator and cover.



7 Way Blade Tester With LEDs

PART#	DESCRIPTION
27096	7-way blade tester with 6 LEDs indicator.



Breakaway Switch With Lanyard

PART#	DESCRIPTION
27098	With 4 ft. of 16 gauge wire. Metal bracket included.



Pictures are not to scale. Sizes are approximate. Specifications subject to change without notice.





Power Jack

- 4000 lb Lifting Power!
- Tracks 10" in 60 seconds
- 12 volt DC powered with manual crank over-ride
- Allows quick break-away from coupler
- Water resistant enclosed motor
- Low noise level during operation
- Fits 2-1/4" mounting holes
- 25" total travel! (8" drop leg, 17" travel)
- 9-3/4" bracket height
- Durable black powder coated finish
- Hardened steel gears
- LED light, easy night time hookups
- Oversize 5-1/2" diameter foot pad
- Weather sealed switch
- Built-in level
- Black plastic cover
- Power cord length: 6' of #10 gauge wire
- 5 yr manufacturer warranty



PART#	VERTICAL LOAD	TRAVEL	DROP LEG	TOTAL TRAVEL	EXTENDED HEIGHT
52700	4,000 lb	17"	8"	25"	34-3/4"

All specifications for jacks are in accordance with the ASABE S 485 standards



"Swing-Way" Jacks with Caster Wheels

- Zinc plated finish
- Perfect for use on tow trailers of various coupler heights.
- Heavy duty swivel mechanism swings and locks jack to transport position.
- Pull-type locking pin secures jack into load-bearing position.
- Supplied with bolt reinforced caster and mounting bracket.
- Fits tongues up to 3" x 5".

PART#	SUPPORT CAPACITY	MAXIMUM LIFT CAPACITY	CASTER WHEEL	LIFT	BRACKET HEIGHT	RETRACTED HEIGHT	EXTENDED HEIGHT	COLOUR BOX
11466	1,600 lb	1,200 lb	6"	10"	12-3/4"	23-1/4"	33-1/4"	Yes
11477	2,000 lb	1,500 lb	8"	10"	12-3/4"	25-1/2"	35-1/2"	No

All specifications for jacks are in accordance with the ASABE S 485 standards

PART#	DESCRIPTION
11466-2	Replacement Wheel for 11466
11477-2	Replacement Wheel for 11477



11466-2



11477-2



Pictures are not scale. Sizes are approximate. Specifications subject to change without notice.

Top Wind with Wheel

PART#	SUPPORT CAPACITY	MAXIMUM LIFT CAPACITY	CASTER WHEEL	LIFT	BRACKET HEIGHT	RETRACTED HEIGHT	EXTENDED HEIGHT	HANDLE
11463	2,000 lb	1,200 lb	6"	15"	8-1/2"	20"	35"	Knob
No Caster	6,000 lb	5,000 lb	-	-	-	-	-	-



Side Wind with Wheel

Non-removable handle

PART#	SUPPORT CAPACITY	MAXIMUM LIFT CAPACITY	CASTER WHEEL	LIFT	BRACKET HEIGHT	RETRACTED HEIGHT	EXTENDED HEIGHT
11467	2,000 lb	1,200 lb	6"	15"	9-1/2"	23-1/2"	38-1/2"
No Caster	2,800 lb	2,000 lb	-	-	-	-	-



Top Wind without Base or Wheel

PART#	SUPPORT CAPACITY	MAXIMUM LIFT CAPACITY	LIFT	BRACKET HEIGHT	RETRACTED HEIGHT	EXTENDED HEIGHT
11492	6,000 lb	5,000 lb	15"	8-1/2"	20"	35"
11493	6,000 lb	5,000 lb	15"	10"	21"	36"
11492-1	Base for 11492, 11493 and 11484 (4" x 7.5")					



Side Wind without Wheel

PART#	SUPPORT CAPACITY	MAXIMUM LIFT CAPACITY	LIFT	BRACKET HEIGHT	RETRACTED HEIGHT	EXTENDED HEIGHT
11484	2,800 lb	2,000 lb	15"	9"	24"	39"



Trailer and Towing



Pictures are not to scale. Sizes are approximate. Specifications subject to change without notice.



Trailer and Towing



Round Tube Mount Jacks, Top Wind

Robust internal gear mechanism and heavy duty rolled threads for smooth operation and dependability. 4-position external mounting tube, lock-pin and handle. Black enamel painted finish. Comes in **Color box**.

PART#	SUPPORT CAPACITY	MAXIMUM LIFT CAPACITY	LIFT	HEIGHT	BRACKET TYPE	RETRACTED HEIGHT	EXTENDED HEIGHT	PKG TYPE
 11468	6,500 lb	5,000 lb	10"	10"	Pipe	15"	25"	Colorbox
 11469	6,500 lb	5,000 lb	15"	15"	Pipe	20-1/4"	35-1/4"	Colorbox



Round Tube Swivel Bracket Mount Jacks, Top Wind

Robust internal gear mechanism and heavy duty rolled threads for smooth operation and dependability. 4-position mounting tube, lock-pin and handle. Black enamel painted finish.

PART#	SUPPORT CAPACITY	MAXIMUM LIFT CAPACITY	LIFT	BRACKET HEIGHT	BRACKET TYPE	RETRACTED HEIGHT	EXTENDED HEIGHT
11470	2,800 lb	2,000 lb	10"	8-1/2"	Flange	15"	25"
 11471	2,800 lb	2,000 lb	15"	13-1/4"	Flange	20"	35"



Side Wind, Round Tube Mount (7-1/2" x 4" Base Plate)

Robust internal gear mechanism and heavy duty rolled threads for smooth operation and dependability. 4-position external mounting tube, lock-pin and handle. Black enamel painted finish. Comes in **Color box**.

PART#	SUPPORT CAPACITY	MAXIMUM LIFT CAPACITY	LIFT	BRACKET HEIGHT	BRACKET TYPE	RETRACTED HEIGHT	EXTENDED HEIGHT	PKG TYPE
 11472	6,500 lb.	5,000 lb	15"	14"	Pipe	22"	37"	Colorbox
 11473	6,500 lb	5,000 lb	10"	9"	Pipe	16-1/2"	26-1/2"	Colorbox



Side Wind, Round Tube Mount (8" x 6" Base Plate)

Robust internal gear mechanism and heavy duty rolled threads for smooth operation and dependability. 4-position external mounting tube, lock-pin and handle. Black enamel painted finish.

PART#	SUPPORT CAPACITY	MAXIMUM LIFT CAPACITY	LIFT	BRACKET HEIGHT	BRACKET TYPE	RETRACTED HEIGHT	EXTENDED HEIGHT
11474	8,400 lb	7,000 lb	10"	9"	Pipe	17"	27"
11475	8,400 lb	7,000 lb	15"	14-1/4"	Pipe	22-1/2"	37-1/2"
11479	6,500 lb	5,000 lb	15"	15"	Pipe	22-1/2"	37-1/2"

Pictures are not scale. Sizes are approximate. Specifications subject to change without notice.

Top Wind, Square Tube Mount

Robust internal gear mechanism & heavy duty rolled threads for smooth operation. Equipped with removable cover, grease fittings, 4-position external mounting tube and lock-pin. Black enamel painted finish.

PART#	SUPPORT CAPACITY	MAXIMUM LIFT CAPACITY	LIFT	BRACKET HEIGHT	BRACKET TYPE	RETRACTED HEIGHT	EXTENDED HEIGHT
11520	2,800 lb	2,000 lb	10"	10"	Pipe	19"	29"
11525	2,800 lb	2,000 lb	15"	10"	Pipe	23"	38"
11535	6,000 lb	5,000 lb	15"	15-3/4"	Pipe	22"	37"



11520

Side Wind, Square Tube Mount

Robust internal gear mechanism & heavy duty rolled threads for smooth operation. Equipped with grease fittings, 4-position mounting tube and lock-pin. Black enamel painted finish.

PART#	SUPPORT CAPACITY	MAXIMUM LIFT CAPACITY	LIFT	BRACKET HEIGHT	BRACKET TYPE	RETRACTED HEIGHT	EXTENDED HEIGHT
11510	2,800 lb	2,000 lb	10"	9"	Pipe	19-1/2"	29-1/2"
11515	2,800 lb	2,000 lb	15"	15"	Pipe	23-1/2"	38-1/2"
11540	6,500 lb	6,000 lb	10"	9"	Pipe	17"	27"



11510

Square Tube Trailer Jack

Robust 2-1/2" square tube. Drop leg adjusts 13" in addition to lift. Features grease fitting for lubrication of mechanism. Black enamel painted finish.

PART#	SUPPORT CAPACITY	MAXIMUM LIFT CAPACITY	TYPE	LIFT	TOTAL TRAVEL	RETRACTED HEIGHT	EXTENDED HEIGHT
11545	6,500 lb	6,000 lb	Side Wind	16"+13"	31"	24-1/2"	53-1/2"



11545

Square Tube "Drop Legs" Jack

Robust 2-1/2" square tube "weld-on" construction. Drop leg adjusts 13" in addition to lift. Features grease fitting for lubrication of mechanism. Black enamel painted finish.

PART#	SUPPORT CAPACITY	MAXIMUM LIFT CAPACITY	TYPE	LIFT	TOTAL TRAVEL	RETRACTED HEIGHT	EXTENDED HEIGHT
11487	8,000 lb	7,000 lb	Top Wind	15" + 13"	28"	22"	50"
11488	8,000 lb	7,000 lb	Side Wind	15" + 13"	28"	24-1/2"	52-1/2"



11487



Trailer and Towing



Pictures are not to scale. Sizes are approximate. Specifications subject to change without notice.



Square Tube "Drop Legs" Jacks - Heavy Duty

Heavy duty 4" square tube "weld-on" construction. Drop leg has 5 position holes and adjusts 13" in addition to lift. Features grease fittings for lubrication of mechanism. Black finish. 12-1/2" lift.

PART#	SUPPORT CAPACITY	MAXIMUM LIFT CAPACITY	TYPE	TOTAL TRAVEL	DROP LEG PIN LOCATION	RETRACTED HEIGHT	EXTENDED HEIGHT
11490	12,000 lb	10,000 lb	Single Speed	25-1/2"	Side	28-1/2"	54"



Levelling Scissor Jacks

Used for stabilizing and levelling 5th wheels and travel trailers. Sturdy steel construction. Designed for today's larger and heavier units. Black finish. Permanently mounted and conveniently concealed when not in use. Easy to install. Comes with wrench.

PART#	SUPPORT CAPACITY	MAXIMUM LIFT CAPACITY
11891	5,000 lb	4" to 24"



Scissor Jack Drill Adapter

Reduces time and effort to raise or lower scissor jacks

PART#	FINISH	FIT
11892	Zinc Plated Finish	3/8" - 1/2"



11454-11455

11500, 11501, 11513

Jack Replacement Parts And Accessories

PART#	DESCRIPTION
11450	Side Wind Handle for 11484/11467
11451	Side Wind Handle for 11510/11515
11452	Side Wind Handle for 11472/11473/11479
11505	Side Wind Handle for 11475/11474/11488/11545/11540
11491	Side Wind Jack Handle for 11490 Jack
11509	Bushing for Jack Handle Side Wind
11454	Quick Release Pin for Jacks 9/16 dia. X 2-1/2 usable length. For 11510/11515/11520/11525
11455	Quick Release Pin for Jacks 5/8 di. X 3-1/4 usable length. For 11545/535/540/468/469/472/473/474/475/479
11500	Mounting Tube External - Large
11501	Mounting Tube Internal - Small
11513	Weld-On Mounting Bracket
11502	Top Wind Jacks Handle (Except 11487)
11487-1	Top Wind Jacks Handle for 11487
11466-2	Wheel Replacement 6" for 11466 Jack
11477-2	Wheel Replacement 8" for 11477 Jack
11477-1	Plastic Cap for 11477 & 11466 Swing-Way Jacks
11492-1	Small Jack Base 4" x 7-1/2" for 11492, 11493 & 11484
11891-1	Replacement Handle for 11891
11545-1	Square Quick Pin For 11545 Base



11491



11451, 11450, 11505



11891-1



11487-1, 11502



11452



11477-1



11509



11492-1



11466-2



11477-2



11545-1

Pictures are not scale. Sizes are approximate. Specifications subject to change without notice.



HD Polyfoam Wheel Chock

This wheel chock is made of structural polyurethane foam. It is stronger, more durable, extremely light weight, odourless and resistant to oil and chemicals. It is bright orange in color for increased visibility. Strong, durable and lightweight. Featuring a molded carry handle for easy carrying and positioning.



PART#	SIZE
11987	9-3/8" x 8" x 5-1/2"

Wheel Chocks

Rubber wheel chock for trailers, cars or other small vehicles. Non-slip surface provides superior traction.

PART#	SIZE
11984	8" x 6" x 4"
11985	10-5/8" x 7" x 4-1/2"



Wheel Chocks

Made from rubber compound with reinforced nylon fiber. Ideal for trailers and heavy loaded vehicles. Eyebolt for easy handling. To be used for vehicles under 20T.

PART#	SIZE
11986	8" x 6" x 10"



Wheel Chocks

Yellow plastic wheel chock. Comes packaged in colour box. 2 wheel chocks per box.

PART#	SIZE
11988	8" x 5" x 4-1/4"



Mud Flaps

Sold separately. Each made of heavy rubber.

PART#	SIZE	THICKNESS	MOUNTING HEAD
11981	24" x 24"	1/4"	5/16"
11982	24" x 30"	1/4"	5/16"
11991	24" x 24"	3/8"	7/16"
11992	24" x 30"	7/16"	7/16"
11993	24" x 36"	7/16"	7/16"



Pictures are not to scale. Sizes are approximate. Specifications subject to change without notice.



LUBRICATION





A		Merchandiser - Grease Accessories	163
Automatic Battery Filler	180	Merchandiser - O-Ring Tilt Bins	164
D		Merchandiser - O-Rings	187
Drain Pans	172	Merchandiser - S.A.E. O-Rings	163
Drive-In Grease Fittings	175	Metal Measurer	181
Drum Bung Adapter	173	Metric Grease Fittings	175
F		Metric O-Rings	186
Fluid Drainer	170	Mini Pistol Grip Grease Gun	166
Fluid Transfer Pump	168	Multi-Purpose Lithium Grease	167
Funnel - & Lubrication Merchandiser	164	Multi-Use Siphon Pump	168
Funnel - Set	177	N	
Funnel - Tree Merchandiser	162	Needle Nose Adapter	173
Funnel - Anti-Splash	178	Needle Nose Dispensers	173
Funnel - Automotive	178	O	
Funnel - Dirt Free	179	Oilers with Base	177
Funnel - Easy Flow	181	P	
Funnel - Flexible Spout	178	Pistol Grip Grease Gun	166
Funnel - Heavy Duty Flex Spout	178	Portable Fluid Pump	170
Funnel - Industrial	177	Premium Heavy Duty Grease Gun	167
Funnel - Multi-Purpose	177	Primer Bulb 1/4" Barb	169
Funnel - Offset Transmission	181	Pump Oilers	176
Funnel - Plastic & Measures Merchandiser	164	R	
Funnel - Replacement Filter	179	Rechargeable Grease Gun Kit	165
Funnel - Super	179	Rotary Barrel Pump	169
Funnel - Tractor	181	S	
Funnel - Transmission	179	S.A.E. Grease Fittings	176
Funnel - Transmission	181	S.A.E. O-rings	182
G		S.A.E. O-rings	183
Grease Box	176	S.A.E. O-rings	184
Grease Coupler - 90°	174	S.A.E. O-rings	185
Grease Couplers	174	Sealable Drain Pan	171
Grease Filler Nipple	174	Seal-able Oil Drain Pan with Wheels	171
Grease Gun	166	Self Priming Copper Pump	168
Grease Gun Holder	174	Standard Duty Grease Gun	167
Grease Gun Pipe	174	Suction Gun	168
Grease Gun Pistol	166	Swivel Grease Coupler	173
Grease Hose	175	T	
Grease Injectors	174	Truck & Trailer Drain Pan	172
H		U	
Heavy Duty Grease Gun	167	Utility Oil Drip Tray	172
High Pressure O-Rings	187		
L			
Lever Action Barrel Pump	169		
Lever Action Pail Pump	169		
Low Profile Oil Drain	171		
Low Profile Oil Drain with Manual Pump	171		
Lubrication Plan-O-Gram	163		
M			
Measurer with Fixed Lid & Nozzle	180		
Measurer with Lid & Nozzle	179		
Measuring Container	180		
Measuring Scoops	180		





Your Trusted Source.



Lubrication

Dynaline offers merchandisers for almost every product. Merchandisers keep your stock organized, visible and easy to shop.



Funnel Tree Merchandiser

PART#	CONTENTS
00628	Funnel Tree Display Only. 3 shelves 36", 32" and 28". 86" high. Includes Header Sign.
00628K	Funnel Tree Merchandiser. 26 part #s, 75 pieces. Includes Funnel Tree rack & header sign.

i Full product breakdown on page 21

Sizes are approximate. Specifications subject to change without notice.





S.A.E. O-Rings Merchandiser 00024 Compatible

PART#	CONTENTS
00318	O-Rings Display Board Only , 24" x 24"
00318K	Full O-Rings Merchandiser . Includes 00318 display board, 110 cornice hooks (65043) and products.

Full product breakdown on page 22



Grease Accessories Merchandiser 00024 Compatible

PART#	CONTENTS
00527	Grease Accessories Display Board Only , 24" x 24"
00527K	Full Grease Accessories Merchandiser . Includes 00057 display board, 41 pegs (80004) and products.

Full product breakdown on page 24

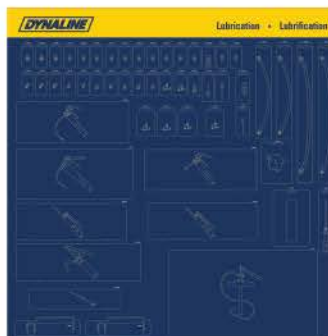

Lubrication Plan-O-Gram

PART#	CONTENTS
01031	Lubrication Backdrop Only , 48" x 48"
01031K	Full Lubrication Plan-O-Gram . Includes 01031 and contents.

Full product breakdown on page 25

Lubrication Plan-O-Gram

PART#	CONTENTS
00063	Lubrication Backdrop Only , 48" x 72"
00063K	Full Lubrication Plan-o-gram . Includes 00063 and products.

Full product breakdown on page 28

Sizes are approximate. Specifications subject to change without notice.

Sizes are approximate. Specifications subject to change without notice.





Lubrication



Funnels & Lubrication Merchandiser

PART#	CONTENTS
01032	Funnels and Lubrication Backdrop Only , 48" x 48"
01032K	Full Funnels and Lubrication Plan-o-gram. Includes 01032 and the products.

i Full product breakdown on page 26



Plastic Funnels & Measures Merchandiser

PART#	CONTENTS
00626	Plastic Funnels & Measurer's Backdrop Only , 48" x 48".
00626K	Full Plastic Funnels & Measures Plan-o-gram. Includes 00626 and the products.

i Full product breakdown on page 27



Reference Chart Available
See end of catalogue



O-Ring Tilt Bins Merchandiser

PART#	CONTENTS
00716K	Full O-Rings Tilt Bin Merchandiser. Dimensions: 23-5/8" x 3-5/8" x 36". Includes Tilt Bins, assembly hardware and the products.

i Full product breakdown on page 23

Sizes are approximate. Specifications subject to change without notice.

11055 - Rechargeable Grease Gun Kit 24V Lithium Ion

- 24 Volt lithium Ion battery (x2)
- 42" Hose with dual anti-kink spring guard
- 12,000 max psi with pressure relief valve
- Grease output: 130 g/min (4.6oz/min)
- LCD battery display
- 1-Hour quick charge station
- Impact resistant case



Replacement Parts for Rechargeable Grease Gun Kit

PART#	DESCRIPTION	PART#	DESCRIPTION
11055-1	24V Li-ion 2000MAH Battery	11055-7	Replacement Plunger
11055-2	Replacement Hose	11055-8	Self-Locking Trigger
11055-3	Rubber Seal	11055-9	Relief Valve
11055-4	Battery Fixed Device	11055-10	Pressure Relief Valve
11055-5	Grease Tube Assembly	11055-11	Vent Valve
11055-6	Replacement Charger		

Sizes are approximate. Specifications subject to change without notice.



Pistol Grip Grease guns allow for one handed use when dispensing grease. This frees the other hand for firmly holding a flex hose onto the fitting. Simply fill these grease guns with 14 oz. cartridges, through a dispenser or bulk loaded. Maximum pressure of over 7,000 PSI.



11066 - Pistol Grip Grease Gun

- Premium Heavy duty model.
- Die cast pump head for strength and durability.
- Knurled barrel for a non-slip grip.
- Convenient one hand operation.
- Uses standard 14 oz. grease cartridges or can be bulk filled.
- Working pressure: 4,500 psi, develops up to 7500 psi.
- Plunger stopper mechanism holds follower rod firmly in place for easy cartridge replacement.
- Includes 16" flexible hose with a protective rubber cap, coupler and bulk filler nipple.
- Variable stroke feature.
- 3 Way loading: filler nipple, bulk, cartridge



11084A - Grease Gun Pistol C/W Hose 18"

- Aluminum die cast pump head for strength and durability.
- Knurled barrel for a non-slip grip.
- Convenient one hand operation.
- Uses standard 14 oz. grease cartridges or can be bulk filled.
- Working pressure: 4,500 psi, develops up to 7,300 psi.
- Locking plunger mechanism holds follower rod firmly in place for easy cartridge replacement.
- Includes 18" flexible hose with a protective rubber cap, 5" steel extension and grease coupler.
- 0.7grams/Pump.
- Includes 18" hose, grease coupler and steel extension.
- Features: Air release valve and bulk filler nipple



11087A - Grease Gun - Pistol 5"

- Aluminum die cast pump head for strength and durability.
- Knurled barrel for a non-slip grip.
- Convenient one hand operation.
- Uses standard 14 oz. grease cartridges or can be bulk filled.
- Working pressure: 4,500 psi, develops up to 7,300 psi.
- Plunger stopper mechanism holds follower rod firmly in place for easy cartridge replacement.
- Includes 5" steel extension with a protective rubber cap and grease coupler.
- 0.7grams/Pump
- Features: Air release valve



11089A - Mini Pistol Grip Grease Gun

- Die cast pump head for strength and durability.
- Knurled barrel for a non-slip grip.
- Convenient one handed operation
- Uses standard 3 oz. grease cartridges or can be bulk filled.
- Working pressure: 2000psi, develops up to 4,000 psi.
- Thumb release catch holds follower rod firmly in place for easy cartridge replacement.
- Includes a 5" steel extension and grease coupler.



Sizes are approximate. Specifications subject to change without notice.



The lever action design of our heavy duty grease guns facilitate accurate control of grease flow. Fitted with a 6" steel curved extension pipe and coupler, these grease guns provide easy access to lubrication points in cars, trucks, tractors and heavy machinery. These grease guns can be loaded with 14 oz. cartridges, through a dispenser or bulk loaded.

11082C - Premium Heavy Duty Grease Gun

- Premium Heavy duty model with cast iron pump head with chrome plated finish
- Variable stroke mechanism
- Knurled barrel for a non-slip grip
- Uses standard 14 oz. grease cartridges or can be bulk filled
- 2.3 gr./stroke
- Plunger stopper holds follower rod firmly in place for easy cartridge replacement
- Includes a 6" steel curved extension pipe and coupler and protective rubber cap
- Working pressure: 4,500 psi, develops up to 10,000 psi
- Features: Air release valve



11083 - Standard Duty Grease Gun

- Standard duty with die cast head
- Knurled barrel for a non-slip grip
- Uses standard 14 oz. grease cartridges or can be bulk filled
- Includes a 6" steel curved extension pipe and coupler
- Plunger stopper holds follower rod firmly in place for easy cartridge replacement
- Working pressure: 4,500 psi, develops up to 10,000 psi
- Features: Air release valve



11085A - Heavy Duty Grease Gun

- Heavy duty with die cast pump head
- Chrome plated finish
- Variable stroke feature
- Knurled barrel for a non-slip grip
- Uses standard 14 oz. grease cartridges or can be bulk filled
- Plunger stopper holds follower rod firmly in place for easy cartridge replacement
- Includes a 6" steel curved extension pipe and coupler
- Working pressure: 4,500 ps develops up to 10,000 psi
- Features: Air release valve



Multi-Purpose Lithium Grease

An excellent multi-purpose extreme pressure grease for ball joints, steering knuckles, chassis, etc. Very good sealing properties to keep water & dirt out. (Formula EP-2)

PART#	FEATURES	DISPLAY BOX
 11073	3 oz. (85g) grease tubes. Clamshell package - 3 pcs	6
11070	14 oz. (400g) grease tube	10



11073



11070

Sizes are approximate. Specifications subject to change without notice.





Oil Suction Gun Provides a fast, clean method of removing and adding transmission fluid, gear oil or oil filter service. It has large 17 ounce fluid capacity with flexible nozzle. Precision follower fitted to barrel for superior suction. Follower impervious to oil, grease and water.

11090A - Suction Gun

- Robust design for easy draining and filling
- Capacity: 17 oz. (500 cc)
- Complete with 12" vinyl hose for transmission and differential service
- Powder coated blue paint
- Precision follower provides superior suction for light grease, water and oil



11093 - Fluid Transfer Pump

- Designed for the direct transfer of gasoline, oil and other non-corrosive fluids from one container to another
- Capacity: 17 oz. (500 cc)
- Rugged construction
- Supplied with two 48" clear vinyl hoses.



11095 - Self Priming Copper Pump

- Glass ball, stainless steel spring and 6' of ethanol resistant hose
- 2.5 Gallon/min
- 1/2" high quality copper pump



11096 - Multi-Use Siphon Pump

- Includes 2 red siphon hoses (51" each) with two 1/2" connectors & 1 adapter
- 1 dipstick tube (47" long)
- 1 liquid/ air pump & siphon
- 1 air pressure hose (15-1/2" long) with 2 piece adapter

Sizes are approximate. Specifications subject to change without notice.

11099 - Primer Bulb 1/4" Barb

- Rubber and aluminum.
- Open pressure: 0.2 bar.
- Working pressure: 0.2 - 6 bar.
- Work temperature: -30c to 130c.



11091 - Lever Action Pail Pump

- For transmission fluid and heavier oils (max. 140 wt.).
- Fits 5 gallon (20 liter) pails.
- Buna-N NBR (Nitrile) sealant material.
- Includes drum cover, 48" delivery hose, 46" usable hose length.
- 1L per 12 strokes, 2 oz. per stroke.



11092A - Lever Action Barrel Pump

Specially designed for the fast transfer of lubricants, solvents, agricultural and industrial chemicals, additives and other non-corrosive liquids from 15 to 55 gallon drums with 2" bung openings.

- Heavy Duty hand operated lever action dispenses approximately 3/4 pint (350 ml) per stroke.
- Equipped with brass rings, self-adjusting telescopic suction tube.
- 2" size bung nut and cushioned vinyl handle tube
- Outlet threaded for standard male garden hose connector or supplied curved spout.
- Zinc-plated corrosion resistant finish.
- Not for use with anti-freeze
- Buna-N NBR (Nitrile) sealant material.



11094A - Rotary Barrel Pump*

- 1" NPT inlet, 1" O.D. discharge spout.
- Heavy duty cast iron construction.
- Smooth easy action.
- 2" NPT threaded bung adapter.
- 3 sections of 1" x 12" suction pipe included
- Compatible with: Diesel, kerosene, machine oil, fuel oil, agricultural fluids, detergents, lube oil, noncorrosive petroleum products
- Delivers 1 gallon per 18 strokes.
- Fits 30 gallon to 55 gallon barrels.
- Can be used for methyl hydrate



***not suitable for use with gasoline, DEF or corrosive fluids**

Sizes are approximate. Specifications subject to change without notice.

Sizes are approximate. Specifications subject to change without notice.





Lubrication



11097 - Portable Fluid Pump

- For transmission fluid and heavier oils.
- Enamel painted finish. Rugged construction.
- Supplied with durable polycarbonate wheels and dispenser hose
- Hand operated pump.
- 5 gallon capacity drum.
- 2 oz. per stroke.
- 3/4" outside hose diameter.
- 1/2" inside hose diameter.
- 73" hose length



11802 - Used Fluid Drainer

Portable, special hose design for faster fluid transfer at any height. Height adjusts from 47-3/4" to 75-3/16" for draining fluids on vehicle lifts. Rugged steel construction.

- Tank capacity: 18 gallons (68.1L).
- Drain bowl capacity: 2.1 gallons (11.4L).
- Heavy duty 13-15/16" diameter drainage funnel with filter screen.
- 2.5 meters long evacuation hose with 1/4" - 18 NPT air coupler.
- Includes regulator and gauge.
- Two large 6" wheels and two 3" swivel casters.
- Working pressure: 10 PSI.
- Gauge: 0-23 PSI in 1/2 PSI increments.
- Drain Hose: 105" long x 1" diameter

Replacement Parts For Used Fluid Drainer (Part# 11802)

PART#	DESCRIPTION	PART#	DESCRIPTION
11802-8	Caster Kit	11802-4	Bowl Kits
11802-7	Wheel Kit	11802-3	Bowl & Ext. Tube Kit
11802-6	Regulator Kit	11802-2	Drain Hose Kit
11802-5	Locking Knob Kit	11802-1	Handle Kit
11802-9	Fluid Drainer Ball Valve	11802-10	Locking Sleeve Kit

Sizes are approximate. Specifications subject to change without notice.



14026 - Sealable Drain Pan

- 10 L capacity
- Seals to keep fluids in during transportation



14028 - Seal-able Oil Drain Pan with Wheels

- 44 L capacity
- Seals to keep fluids in during transportation
- Handles on end for easy transportation



14032 - Low Profile Oil Drain with Manual Pump

- 64 L capacity (17 gallon)
- 8' evacuation hose
- 5' suction distance
- 16.5' lift distance
- 0.3 L / rotation flow rate
- Caster wheels allow for easy mobility
- Long handle for easy mobility

PART#	DESCRIPTION
14032-1	Iron Manual Pump for 14032



14033 - Low Profile Oil Drain - 64L w/ 12V DC Battery Pump

- Durable high-density polyethylene construction tank
- Capacity: 64L (17 gallon).
- Built-in 12v dc battery pump.
- 5.9 ft evacuation hose with metal J-spout for fast fluid draining.
- 3.3 ft suction distance
- 16.4ft lift distance
- 15l/min flow rate
- Includes T-handle and four 4in heavy duty casters
- Includes a mesh anti-splash cover

PART#	DESCRIPTION
14033-1	12V DC Electrical Pump for 14033



Sizes are approximate. Specifications subject to change without notice.





14019

Truck & Trailer Drain Pan

Made of rugged high-density polyethylene. Features easy to use carrying handles.

PART#	DESCRIPTION	CAPACITY
14019	Fits rims 13-3/4" (inside diameter) and larger.	3L



14022

14023



Drain Pans

Made of rugged high-density polyethylene.

PART#	CAPACITY	LENGTH	DEPTH	WIDTH
14022	16L	23"	5-1/2"	18"
14023	24L	32"	7-1/2"	21-1/2"



14048

Utility Oil Drip Tray

Heavy duty polyethylene construction - black color.

PART#	CAPACITY	LENGTH	WIDTH	HEIGHT
14048	52L	24"	24"	5-1/2"
14049	78L	36"	24"	5-1/2"
14050	103L	48"	24"	5-1/2"

Sizes are approximate. Specifications subject to change without notice.



Drum Bung Adapter

PART#	DESCRIPTION	DISPLAY BOX QTY
11074	Fits 2" NPT North American drums. Durable neoprene seal. 3/4" opening. Made from durable PP plastic.	12



11071A - 360° Swivel Grease Coupler

- Swivels in full 360° circle & locks at any 45° position.
- Specifically designed for vehicles & equipment with hard-to-reach fittings.
- 1/8" NPT female inlet, 7,000 psi.
- 1 pc. in clamshell package.



Needle Nose Dispensers

Universal joints, tough to reach areas, 1/8" threads.

PART#	FEATURES	OVERALL LENGTH
11075A	1-1/2" Needle Nose Dispenser. 1 pc. in clamshell package.	2-3/4"
11080A	For dispensing a fine line of grease. 1 pc. in clamshell package.	1-1/2"



Needle Nose Adapter

PART#	FEATURES	OVERALL LENGTH
11076	4" long. For hard-to-reach grease points. Supplied with locking sleeve to fit all grease couplers. In clamshell package.	7-1/4"



Drum Bung Adapter

- Prevents contaminants from entering drum
- Design to last
- Wipes stinger clean



11074

Sizes are approximate. Specifications subject to change without notice.



Grease Gun Holder

PART#	FEATURES
<input type="checkbox"/> 11077	Holds grease guns and suction guns with 2-1/4" diameter barrel. Easily mounts on most surfaces.



Grease Injectors

For sealed bearings and joints. Supplied in a blister package.

PART#	FEATURES	QTY. PER PKG.
<input type="checkbox"/> 11122	18 gauge x 1-1/2" long.	3
<input type="checkbox"/> 11123A	18 gauge x 1-1/2" long.	1
<input type="checkbox"/> 11124A	18 gauge x 1-1/2" long	2



90° Grease Coupler

PART#	FEATURES
<input type="checkbox"/> 11081A	Can be used where space is a problem or as a general purpose grease coupler. Fits all standard grease guns. 1 piece in clamshell package.



11121



11125

Grease Couplers

With ball check and hex nut on body end. Fits over grease fittings.

PART#	FEATURES	QTY. PER PKG.
<input type="checkbox"/> 11121	6,000 psi. 1/8" NPT Coupler. For light to medium duty applications.	10
<input type="checkbox"/> 11121A	6,000 psi. 1/8" NPT Coupler. For light to medium duty applications.	1 (Dynapak)
<input type="checkbox"/> 11125	10,000 psi. 1/8" NPT Coupler. For heavy duty applications.	5
<input type="checkbox"/> 11125A	10,000 psi. 1/8" NPT Coupler. For heavy duty applications.	1 (Dynapak)



Grease Filler Nipple

Fits into Grease Gun heads.

PART#	FEATURES	QTY. PER PKG.
<input type="checkbox"/> 11079A	Grease filler nipple, in Dynapak.	1 ea.



Grease Gun Pipe

For manual grease guns only.

PART#	LENGTH	ENDS	SAFE WORKING PRESSURE	PACKAGE TYPE
<input type="checkbox"/> 11078	5-1/2"	1/8" NPT	6,000 PSI	Polybag

Sizes are approximate. Specifications subject to change without notice.



Grease Hose - Nylon

Reinforced thermoplastic cover with nylon braid:

PART#	LENGTH	ENDS	SAFE WORKING PRESSURE	WORKING TEMPERATURE	PACKAGE TYPE
11140	12"	1/8" NPT	4,500 PSI	-40°C to 95°C	Retail pkg.
11141	18"	1/8" NPT	4,500 PSI	-40°C to 95°C	Retail pkg.



11144



Grease Hose - Steel wire

Reinforced rubber cover with steel wire braid:

PART#	LENGTH	ENDS	SAFE WORKING PRESSURE	WORKING TEMPERATURE	PACKAGE TYPE
11144	24"	1/8" NPT	3,600 PSI	-40°C to 95°C	Bulk with UPC label
11142A	12"	1/8" NPT	3,600 PSI	-40°C to 95°C	Retail pkg
11143A	18"	1/8" NPT	3,600 PSI	-40°C to 95°C	Retail pkg



Grease Hose - Steel wire (in display box)

Reinforced rubber cover with steel wire braid. Working temperature: -40° to 95°C. Each grease hose is individually UPC barcode labeled inside a full colour display box.

PART#	LENGTH	ENDS	SAFE WORKING PRESSURE	WORKING TEMPERATURE	PACKAGE TYPE
11142	12"	1/8" NPT	3,600 PSI	-40°C to 95°C	10/ Package
11143	18"	1/8" NPT	3,600 PSI	-40°C to 95°C	10/ Package



Straight



90°

45°

Drive-In



Bulk-Pak

Mini-Pak



Dyna-Pak

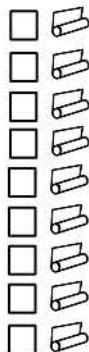

Metric Grease Fittings

Tested to 8,000 PSI, 08F Carbon Steel. Zinc plated finish.

BULK PACK PART#	QTY.	MINI-PACK PART#	QTY.	DYNAPAK PART#	QTY.	TYPE	THREAD	OVERALL LENGTH (MM)	INDUSTRY NUMBER
11114	100	11414	25	11114A	5	Straight	M6 x 1	15	2106
11115	100	11415	25	11115A	5	45°	M6 x 1	20.50	2107
11116	100	11416	25	11116A	5	90°	M6 x 1	19	2108
11117	100	11417	25	11117A	5	Straight	M8 x 1	15.7	2103
11118	100	11418	25	11118A	5	45°	M8 x 1	20.5	2104
11119	100	11419	25	11119A	5	90°	M8 x 1	19	2105
11120	100	11420	25	11120A	5	Straight	M10 x 1	16	2109
11126	100	11426	25	11126A	5	45°	M10 x 1	22.60	2110
11127	100	11427	25	11127A	5	90°	M10 x 1	21.40	2111

Drive-In Grease Fittings

Use a drive-in grease fitting tool to tap into desired area. Tested to 8,000 PSI, 08F Carbon Steel. Zinc plated finish.

BULK PACK PART#	QTY.	MINI-PACK PART#	QTY.	DYNAPAK PART#	QTY.	TYPE	DRILL SIZE	OVERALL LENGTH	INDUSTRY NUMBER
11131	100	11431	25	11131A	5	Drive In	3/16"	33/64"	1728-B
11132	100	11432	25	11132A	5	Drive In	1/4"	35/64"	1743-B
11133	100	11433	25	11133A	5	Drive In	5/16"	35/64"	1608-B
11134	100	11434	25	11134A	5	Drive In	3/8"	37/64"	1666 (With Ball Check)

Sizes are approximate. Specifications subject to change without notice.



Lubrication

Grease Tube Containers • Oilers • Grease Fittings

1.877.453.3964

1.877.453.5050

www.dynaline.com

orders@dynaline.com



Lubrication

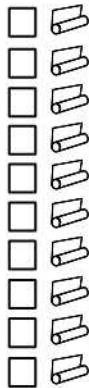

S.A.E. Grease Fittings (Grease Zerks)

Tested to 8,000 PSI, 08F Carbon Steel. Zinc plated finish.

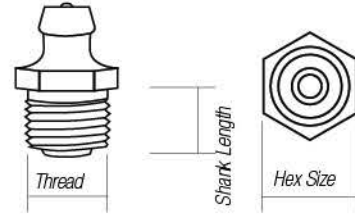

BULK PACK PART#	QTY.	MINI-PACK PART#	QTY.	DYNAPAK PART#	QTY.	TYPE	THREAD	OVERALL LENGTH	SHANK LENGTH (MM)	HEX SIZE (MM)	INDUSTRY NUMBER
11100	100	11400	25	11100A	10	Straight	1/8" NPT*	21/32" (17.52mm)	7.51	11	1610
11102	100	11402	25	11102A	5	45°	1/8" NPT*	7/8" (22.60mm)	7.5	11	1688
11104	100	11404	25	11104A	5	90°	1/8" NPT*	27/32" (21.40mm)	7.5	11	1613
11105	100	11405	25	11105A	10	Straight	1/4" - 28	1/2" (13.97mm)	4.8	8mm	1641
11106	100	11406	25	11106A	10	Straight	1/4" - 28 Long	11/16" (17.5mm)	9.1	8	1652
11107	100	11407	25	11107A	5	45°	1/4" - 28	7/8" (20.57mm)	5.15	9.5	1637
11109	100	11409	25	11109A	5	90°	1/4" - 28	25/32" (19.05mm)	5.15	9.5	1911
11110	50	11410	25	11110A	5	Straight	1/4" NPT*	15/16" (22.35mm)	10.7	14.3	1627
11112	100	11412	25	11112A	5	Straight	5/16" - 24UNF	21/32" (14.30mm)	4	9.50	1711
11113	100	11413	25	11113A	5	Straight	3/8" - 24UNF	9/16" (15.75mm)	6.35	11	1710

* NPT - National Pipe Thread **UNF - Unified National Fine *** Threads Per Inch



13000 - Grease Box

- A convenient and durable storage container for grease tubes.
- Features snap top lid, grip handles & carry strap.
- Provides safe storage and transportation, preventing spills & contamination.
- Stores 12 tubes upright, dust caps on.



Pistol

Thumb Pump

Pump Oilers

Seamless steel body and brass pump mechanism. Durable enamel painted finish. Supplied with flexible and rigid metal spouts.

PART#	TYPE	CAPACITY
13604	Pistol	4.4 oz. (125 cc)
13607	Thumb Pump	7 oz. (200 cc)
13610	Thumb Pump	10.6 oz. (300 cc)
13617	Thumb Pump	17 oz. (500 cc)
13624	Thumb Pump	24 oz. (700 cc)

Sizes are approximate. Specifications subject to change without notice.



Oilers with Base

Ideal for oils, acids, adhesives, etc. Will not rust, leak or dent. Made of flexible, durable polyethylene. Removeable base for easy cleaning.

DYNALINE		CLUTHÉ		
PART#	PART#	DESCRIPTION		
13030	C30300	3" Nozzle, 6 oz./180 ml capacity, natural		
13031	C30310	3" Nozzle, 10 oz./284 ml capacity, natural		



Multi-Purpose Funnels (Single)

Flexible, durable, spark-proof, dent-proof, rust-proof polyethylene. Features a handy hang-up tab.

DYNALINE		CLUTHÉ					
PART#	PART#	SIZE	CAPACITY	SPOUT DIAMETER	SPOUT LENGTH	OPENING DIAMETER	
13504	C35040	4"	8 oz. (237ml)	1/2"	2-1/2"	3-7/8"	
13505	C35050	5"	14 oz. (414 ml)	1/2"	1-1/4"	4-3/4"	
13506		6"	32 oz. (946 ml)	5/8"	2"	5-3/4"	
13507	C35070	7"	28 oz. (828 ml)	1/2"	2-1/2"	6-3/4"	
13508		8"	120 oz. (3.55 L)	1"	3-7/8"	7-5/8"	
13510		10"	160 oz. (4.73 L)	1-1/2"	3-7/8"	9-7/8"	



Funnel Set

PART#	DESCRIPTION
13503	• 3 Piece, One each of: 4", 5" and 6" Multi-Purpose Funnels
13511	• 4 Piece, One each of: 2", 3", 4", 5" Multi-Purpose Funnels.



Industrial Funnels

Made of flexible, durable, spark-proof, dent-proof, rust-proof, clear polyethylene. Features a handy hang-up tab. Supplied with one 100 mesh filter.

DYNALINE		CLUTHÉ					
PART#	PART#	SIZE	CAPACITY	SPOUT DIAMETER	SPOUT LENGTH	OPENING DIAMETER	
13003	C30030	3"	6 oz. (177 ml)	3/16"	1-7/8"	3"	
13005	C30050	5"	24 oz. (710 ml)	1/2"	2-1/4"	5-3/8"	
13009	C30090	9"	144 oz. (4.26 L)	1"	3-3/8"	8-1/2"	



Sizes are approximate. Specifications subject to change without notice.





Automotive Funnel

Made of flexible, durable, spark-proof, dent-proof, rust-proof, clear polyethylene. Features a handy hang-up tab. Supplied with one 100 mesh filter.

DYNALINE **CLUTHÉ**

PART#	PART#	SIZE	CAPACITY	SPOUT DIAMETER	SPOUT LENGTH	OPENING DIAMETER
13008	C30080	8"	120 oz. (3.5 L)	7/8"	5-1/4"	7-1/2"



13015

Anti-Splash Funnel

Made of flexible, durable, spark-proof, dent-proof, rust-proof, clear polyethylene. Features a handy hang-up tab. Supplied with anti-splash rim and one 100 mesh filter.

DYNALINE **CLUTHÉ**

PART#	PART#	SIZE	CAPACITY	SPOUT DIAMETER	SPOUT LENGTH	OPENING DIAMETER
13015	C30150	5"	24 oz. (710 ml)	1/2"	2-1/4"	5-1/4"
13019	C30190	9"	144 oz. (4.26 L)	1"	3-3/8"	8-1/4"



2-In-1 Flexible Spout Funnel

Complete with mesh filter. Detachable spout.

PART#	SIZE	SPOUT DIAMETER	SPOUT LENGTH	OPENING DIAMETER
14015	15.6"	3/8"	10"	6-1/2"



Assembled

Heavy Duty Flex Spout Funnel

Heavy duty. Complete with metal filter screen.

PART#	OVERALL LENGTH	COLOUR	OPENING DIAMETER	SPOUT DIAMETER
14013	17"	Orange	7"	3/4"

Sizes are approximate. Specifications subject to change without notice.



Replacement Funnel Filter

Fits industrial, automotive and anti-splash funnels.

PART#	FEATURES	DIAMETER	QTY. PER PKG.
13100	100 Mesh	2"	10



Transmission Funnel

Detachable spout.



PART#	OVERALL LENGTH	SPOUT DIAMETER	SPOUT LENGTH	OPENING DIAMETER
14017	22"	3/8"	16"	5-1/2"



Super Funnel

PART#	OVERALL LENGTH	SPOUT DIAMETER	SPOUT LENGTH	OPENING DIAMETER
14018	18"	3/8"	7"	5"



Dirt Free Funnels

Flexible, durable, spark proof, dent proof, leak proof. Large handle. Removable caps on opening and spout prevent foreign material from entering when not in use.



PART#	OVERALL LENGTH	COLOUR	OPENING DIAMETER	SPOUT DIAMETER
14035	15"	Yellow	4-1/2"	5/8"
14037	17"	Orange	4-1/2"	9/16"



Measurer with Lid & Nozzle

Will not rust, dent or leak. Ideal for handling all kinds of fluids. Embedded lid and nozzle.

PART#	CAPACITY	SPOUT DIAMETER	SPOUT LENGTH
14040	1 gal. (4 L)	5/8"	2-3/4" to 8-1/4"



Sizes are approximate. Specifications subject to change without notice.





14025/ 13402

Measuring Container

US, Imperial, and Metric graduations. Ideal for fluids and dry material.

DYNALINE **CLUTHE**

PART#	PART#	CAPACITY	DESCRIPTION
13402	C34026	84.5 oz./2.5L	Calibrated measurer with detachable lid and nozzle
14025	C34020	84.5 oz./2.5L	Calibrated measurer
14045X	C34046	152 oz./4.5L	Calibrated measurer with detachable lid and nozzle
13404	C34040	152 oz./4.5L	Calibrated measurer



Measurer with Fixed Lid & Nozzle

US, Imperial, and Metric graduations. Ideal for fluids and dry material.

PART#	CAPACITY	SPOUT DIAMETER	SPOUT LENGTH	LID TYPE
14045	152 oz. (4.5L)	7/16"	5"	Blow molded fixed lid



Measuring Scoops

US, Imperial, and Metric graduations. Ideal for handling dry materials.

DYNALINE **CLUTHE**

PART#	PART#	CAPACITY	DESCRIPTION
13311	C33110	52 oz. (1.5L)	7" scoop, 11-1/2" overall length, translucent
13314	C33140	104 oz. (3L)	10" overall length, translucent



Automatic Battery Filler

Safety nozzle/push-in style. Automatic shut-off to help prevent spilling and over filling.

PART#	CAPACITY	SPOUT DIAMETER	SPOUT LENGTH
14024	1/2 gal. (2 L)	7/32"	2-1/2"

Sizes are approximate. Specifications subject to change without notice.



Easy Flow Funnel

Offset spout for the hard to reach areas. For oils and other engine fluids. Perfect for small engines, lawnmowers, ATV's, Motorcycles, Tractors, Generators, Pressure washers, Trucks and Motorized equipment.

PART#	CAPACITY	LENGTH	SPOUT DIAMETER	DIAMETER
13007	1L	16"	1/2"	4.5"



Tractor Funnel

Heavy duty galvanized steel. Comes with one gold mesh filter, 11-1/2" high.

PART#	CAPACITY	DIAMETER	TIP OUTSIDE DIAMETER	SPOUT DIAMETER	SPOUT LENGTH
13811	8 qt. (7.5 L)	9-1/2"	1"	1"	3-5/8"



Offset Transmission Funnel

PART#	CAPACITY	DIAMETER	FIXED SPOUT DIAMETER	FLEX SPOUT DIAMETER	FLEX SPOUT LENGTH
14008	2 L	7"	1"	5/8"	17"



Transmission Funnel

Galvanized metal. Complete with mesh filter.

PART#	CAPACITY	DIAMETER	FIXED SPOUT DIAMETER	FLEX SPOUT DIAMETER	FLEX SPOUT LENGTH
14014	1 L	5-1/2"	5/8"	1/2"	14"



Metal Measurer

Made of heavy duty galvanized steel. Complete with flex spout and easy grip handle.

PART#	CAPACITY	SPOUT DIAMETER	SPOUT LENGTH
14140	4 qt. (4 L)	1/2"	7-1/2"



Sizes are approximate. Specifications subject to change without notice.



S.A.E. O-rings

Used for petroleum based fuel/oil, water, alcohol, some acids and bases.
Temperature range -55°C to 120°C. Buna N-70R Nitrile Durometer A.
Conforms to ASTM D2000 M2BF714, B14, EA14, EF11, EF21, EO14 & EO34.

PART#	INDUSTRY NUMBER	THICKNESS	INSIDE DIAMETER	OUTSIDE DIAMETER	QTY PER PKG.
54006	6	1/16"	1/8"	1/4"	Pkg. of 15
54007	7	1/16"	5/32"	9/32"	Pkg. of 15
54008	8	1/16"	3/16"	5/16"	Pkg. of 15
54009	9	1/16"	7/32"	11/32"	Pkg. of 15
54010	10	1/16"	1/4"	3/8"	Pkg. of 15
54011	11	1/16"	5/16"	7/16"	Pkg. of 15
54012	12	1/16"	3/8"	1/2"	Pkg. of 15
54013	13	1/16"	7/16"	9/16"	Pkg. of 10
54014	14	1/16"	1/2"	5/8"	Pkg. of 10
54015	15	1/16"	9/16"	11/16"	Pkg. of 10
54016	16	1/16"	5/8"	3/4"	Pkg. of 10
54017	17	1/16"	11/16"	13/16"	Pkg. of 10
54018	18	1/16"	3/4"	7/8"	Pkg. of 10
54019	19	1/16"	13/16"	15/16"	Pkg. of 10
54020	20	1/16"	7/8"	1"	Pkg. of 10
54021	21	1/16"	15/16"	1-1/16"	Pkg. of 10
54022	22	1/16"	1"	1-1/8"	Pkg. of 10
54023	23	1/16"	1-1/16"	1-3/16"	Pkg. of 10
54024	24	1/16"	1-1/8"	1-1/4"	Pkg. of 10
54025	25	1/16"	1-3/16"	1-5/16"	Pkg. of 10
54026	26	1/16"	1-1/4"	1-3/8"	Pkg. of 10
54027	27	1/16"	1-5/16"	1-7/16"	Pkg. of 10
54028	28	1/16"	1-3/8"	1-1/2"	Pkg. of 10
54110	110	3/32"	3/8"	9/16"	Pkg. of 15
54111	111	3/32"	7/16"	5/8"	Pkg. of 15
54112	112	3/32"	1/2"	11/16"	Pkg. of 15
54113	113	3/32"	9/16"	3/4"	Pkg. of 15
54114	114	3/32"	5/8"	13/16"	Pkg. of 15
54115	115	3/32"	11/16"	7/8"	Pkg. of 15
54116	116	3/32"	3/4"	15/16"	Pkg. of 15
54117	117	3/32"	13/16"	1"	Pkg. of 10
54118	118	3/32"	7/8"	1-1/16"	Pkg. of 10
54119	119	3/32"	15/16"	1-1/8"	Pkg. of 10
54120	120	3/32"	1"	1-3/16"	Pkg. of 10
54121	121	3/32"	1-1/16"	1-1/4"	Pkg. of 10
54122	122	3/32"	1-1/8"	1-5/16"	Pkg. of 10
54123	123	3/32"	1-3/16"	1-3/8"	Pkg. of 10
54124	124	3/32"	1-1/4"	1-7/16"	Pkg. of 10
54125	125	3/32"	1-5/16"	1-1/2"	Pkg. of 10
54126	126	3/32"	1-3/8"	1-9/16"	Pkg. of 10
54127	127	3/32"	1-7/16"	1-5/8"	Pkg. of 10

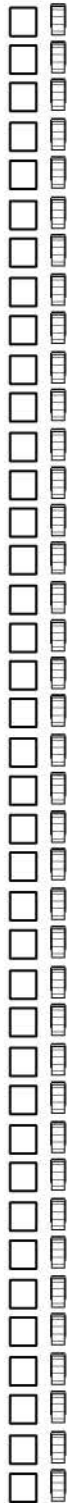

Sizes are approximate. Specifications subject to change without notice.



Lubrication



S.A.E. O-rings

Used for petroleum based fuel/oil, water, alcohol, some acids and bases.
Temperature range -55°C to 120°C. Buna N-70R Nitrile Durometer A.
Conforms to ASTM D2000 M2BF714, B14, EA14, EF11, EF21, EO14 & EO34.

PART#	INDUSTRY NUMBER	THICKNESS	INSIDE DIAMETER	OUTSIDE DIAMETER	QTY PER PKG.	
<input type="checkbox"/>	54128	128	3/32"	1-1/2"	1-11/16"	Pkg. of 10
<input type="checkbox"/>	54129	129	3/32"	1-9/16"	1-3/4"	Pkg. of 10
<input type="checkbox"/>	54130	130	3/32"	1-5/8"	1-13/16"	Pkg. of 10
<input type="checkbox"/>	54131	131	3/32"	1-11/16"	1-7/8"	Pkg. of 10
<input type="checkbox"/>	54132	132	3/32"	1-3/4"	1-15/16"	Pkg. of 10
<input type="checkbox"/>	54133	133	3/32"	1-13/16"	2"	Pkg. of 10
<input type="checkbox"/>	54134	134	3/32"	1- 7/8"	2-1/16"	Pkg. of 10
<input type="checkbox"/>	54135	135	3/32"	1-15/16"	2-1/8"	Pkg. of 10
<input type="checkbox"/>	54136	136	3/32"	2"	2-3/16"	Pkg. of 10
<input type="checkbox"/>	54137	137	3/32"	2-1/16"	2-1/4"	Pkg. of 10
<input type="checkbox"/>	54138	138	3/32"	2-1/8"	2-5/16"	Pkg. of 10
<input type="checkbox"/>	54139	139	3/32"	2-3/16"	2-3/8"	Pkg. of 10
<input type="checkbox"/>	54140	140	3/32"	2-1/4"	2-7/16"	Pkg. of 10
<input type="checkbox"/>	54141	141	3/32"	2-5/16"	2-1/2"	Pkg. of 10
<input type="checkbox"/>	54142	142	3/32"	2-3/8"	2-9/16"	Pkg. of 10
<input type="checkbox"/>	54143	143	3/32"	2-7/16"	2-5/8"	Pkg. of 10
<input type="checkbox"/>	54144	144	3/32"	2-1/2"	2-11/16"	Pkg. of 10
<input type="checkbox"/>	54145	145	3/32"	2-9/16"	2-3/4"	Pkg. of 10
<input type="checkbox"/>	54146	146	3/32"	2-5/8"	2-13/16"	Pkg. of 10
<input type="checkbox"/>	54147	147	3/32"	2-11/16"	2-7/8"	Pkg. of 10
<input type="checkbox"/>	54148	148	3/32"	2-3/4"	2-15/16"	Pkg. of 10
<input type="checkbox"/>	54149	149	3/32"	2-13/16"	3"	Pkg. of 10
<input type="checkbox"/>	54210	210	1/8"	3/4"	1"	Pkg. of 10
<input type="checkbox"/>	54211	211	1/8"	13/16"	1-1/16"	Pkg. of 10
<input type="checkbox"/>	54212	212	1/8"	7/8"	1-1/8"	Pkg. of 10
<input type="checkbox"/>	54213	213	1/8"	15/16"	1-3/16"	Pkg. of 10
<input type="checkbox"/>	54214	214	1/8"	1"	1-1/4"	Pkg. of 10
<input type="checkbox"/>	54215	215	1/8"	1-1/16"	1-5/16"	Pkg. of 10
<input type="checkbox"/>	54216	216	1/8"	1-1/8"	1-3/8"	Pkg. of 10
<input type="checkbox"/>	54217	217	1/8"	1-3/16"	1-7/16"	Pkg. of 10
<input type="checkbox"/>	54218	218	1/8"	1-1/4"	1-1/2"	Pkg. of 10
<input type="checkbox"/>	54219	219	1/8"	1-5/16"	1-9/16"	Pkg. of 10
<input type="checkbox"/>	54220	220	1/8"	1-3/8"	1-5/8"	Pkg. of 10
<input type="checkbox"/>	54221	221	1/8"	1-7/16"	1-11/16"	Pkg. of 10
<input type="checkbox"/>	54222	222	1/8"	1-1/2"	1-3/4"	Pkg. of 10
<input type="checkbox"/>	54223	223	1/8"	1-5/8"	1-7/8"	Pkg. of 10
<input type="checkbox"/>	54224	224	1/8"	1-3/4"	2"	Pkg. of 10
<input type="checkbox"/>	54225	225	1/8"	1-7/8"	2-1/8"	Pkg. of 10
<input type="checkbox"/>	54226	226	1/8"	2"	2-1/4"	Pkg. of 10
<input type="checkbox"/>	54227	227	1/8"	2-1/8"	2-3/8"	Pkg. of 10
<input type="checkbox"/>	54228	228	1/8"	2-1/4"	2-1/2"	Pkg. of 10



Lubrication

Sizes are approximate. Specifications subject to change without notice.



S.A.E. O-rings

Used for petroleum based fuel/oil, water, alcohol, some acids and bases.
 Temperature range -55°C to 120°C. Buna N-70R Nitrile Durometer A.
 Conforms to ASTM D2000 M2BF714, B14, EA14, EF11, EF21, EO14 & EO34.



Lubrication



	PART#	INDUSTRY NUMBER	THICKNESS	INSIDE DIAMETER	OUTSIDE DIAMETER	QTY PER PKG.
<input type="checkbox"/>	54229	229	1/8"	2-3/8"	2-5/8"	Pkg. of 10
<input type="checkbox"/>	54230	230	1/8"	2-1/2"	2-3/4"	Pkg. of 10
<input type="checkbox"/>	54231	231	1/8"	2-5/8"	2-7/8"	Pkg. of 10
<input type="checkbox"/>	54232	232	1/8"	2-3/4"	3"	Pkg. of 10
	54233	233	1/8"	2-7/8"	3-1/8"	Pkg. of 10
	54234	234	1/8"	3"	3-1/4"	Pkg. of 10
<input type="checkbox"/>	54235	235	1/8"	3-1/8"	3-3/8"	Pkg. of 10
<input type="checkbox"/>	54236	236	1/8"	3-1/4"	3-1/2"	Pkg. of 10
	54237	237	1/8"	3-3/8"	3-5/8"	Pkg. of 10
	54238	238	1/8"	3-1/2"	3-3/4"	Pkg. of 10
	54239	239	1/8"	3-5/8"	3-7/8"	Pkg. of 10
	54240	240	1/8"	3-3/4"	4"	Pkg. of 10
	54241	241	1/8"	3-7/8"	4-1/8"	Pkg. of 10
	54242	242	1/8"	4"	4-1/4"	Pkg. of 10
	54243	243	1/8"	4-1/8"	4-3/8"	Pkg. of 10
	54244	244	1/8"	4-1/4"	4-1/2"	Pkg. of 10
	54245	245	1/8"	4-3/8"	4-5/8"	Pkg. of 10
	54246	246	1/8"	4-1/2"	4-3/4"	Pkg. of 10
	54247	247	1/8"	4-5/8"	4-7/8"	Pkg. of 10
	54248	248	1/8"	4-3/4"	5"	Pkg. of 10
	54249	249	1/8"	4-7/8"	5-1/8"	Pkg. of 5
	54250	250	1/8"	5"	5-1/4"	Pkg. of 5
	54251	251	1/8"	5-1/8"	5-3/8"	Pkg. of 5
	54252	252	1/8"	5-1/4"	5-1/2"	Pkg. of 5
	54253	253	1/8"	5-3/8"	5-5/8"	Pkg. of 5
	54254	254	1/8"	5-1/2"	5-3/4"	Pkg. of 5
	54255	255	1/8"	5-5/8"	5-7/8"	Pkg. of 5
	54256	256	1/8"	5-3/4"	6"	Pkg. of 5
	54257	257	1/8"	5-7/8"	6-1/8"	Pkg. of 5
	54258	258	1/8"	6"	6-1/4"	Pkg. of 5
<input type="checkbox"/>	54325	325	3/16"	1-1/2"	1-7/8"	Pkg. of 5
<input type="checkbox"/>	54326	326	3/16"	1-5/8"	2"	Pkg. of 5
<input type="checkbox"/>	54327	327	3/16"	1-3/4"	2-1/8"	Pkg. of 5
<input type="checkbox"/>	54328	328	3/16"	1-7/8"	2-1/4"	Pkg. of 5
<input type="checkbox"/>	54329	329	3/16"	2"	2-3/8"	Pkg. of 5
<input type="checkbox"/>	54330	330	3/16"	2-1/8"	2-1/2"	Pkg. of 5
<input type="checkbox"/>	54331	331	3/16"	2-1/4"	2-5/8"	Pkg. of 5
<input type="checkbox"/>	54332	332	3/16"	2-3/8"	2-3/4"	Pkg. of 5
<input type="checkbox"/>	54333	333	3/16"	2-1/2"	2-7/8"	Pkg. of 5
<input type="checkbox"/>	54334	334	3/16"	2-5/8"	3"	Pkg. of 5
<input type="checkbox"/>	54335	335	3/16"	2-3/4"	3-1/8"	Pkg. of 5
<input type="checkbox"/>	54336	336	3/16"	2-7/8"	3-1/4"	Pkg. of 5

Sizes are approximate. Specifications subject to change without notice.

Legend: 12x24 24x24 Plan-O-Gram Rack/End Cap Funnel Tree Other



S.A.E. O-rings

Used for petroleum based fuel/oil, water, alcohol, some acids and bases.
Temperature range -55°C to 120°C. Buna N-70R Nitrile Durometer A.
Conforms to ASTM D2000 M2BF714, B14, EA14, EF11, EF21, EO14 & EO34.

PART#	INDUSTRY NUMBER	THICKNESS	INSIDE DIAMETER	OUTSIDE DIAMETER	QTY PER PKG.
54337	337	3/16"	3"	3-3/8"	Pkg. of 5
54338	338	3/16"	3-1/8"	3-1/2"	Pkg. of 5
54339	339	3/16"	3-1/4"	3-5/8"	Pkg. of 5
54340	340	3/16"	3-3/8"	3-3/4"	Pkg. of 5
54341	341	3/16"	3-1/2"	3-7/8"	Pkg. of 5
54342	342	3/16"	3-5/8"	4"	Pkg. of 5
54343	343	3/16"	3-3/4"	4-1/8"	Pkg. of 5
54344	344	3/16"	3-7/8"	4-1/4"	Pkg. of 5
54345	345	3/16"	4"	4-3/8"	Pkg. of 5
54346	346	3/16"	4-1/8"	4-1/2"	Pkg. of 5
54347	347	3/16"	4-1/4"	4-5/8"	Pkg. of 5
54348	348	3/16"	4-3/8"	4-3/4"	Pkg. of 5
54349	349	3/16"	4-1/2"	4-7/8"	Pkg. of 5
54350	350	3/16"	4-5/8"	5"	Pkg. of 5
54425	425	1/4"	4-1/2"	5"	Pkg. of 2
54426	426	1/4"	4-5/8"	5-1/8"	Pkg. of 2
54427	427	1/4"	4-3/4"	5-1/4"	Pkg. of 2
54428	428	1/4"	4-7/8"	5-3/8"	Pkg. of 2
54429	429	1/4"	5"	5-1/2"	Pkg. of 2
54430	430	1/4"	5-1/8"	5-5/8"	Pkg. of 2
54431	431	1/4"	5-1/4"	5-3/4"	Pkg. of 2
54432	432	1/4"	5-3/8"	5-7/8"	Pkg. of 2
54433	433	1/4"	5-1/2"	6"	Pkg. of 2
54434	434	1/4"	5-5/8"	6-1/8"	Pkg. of 2
54435	435	1/4"	5-3/4"	6-1/4"	Pkg. of 2
54436	436	1/4"	5-7/8"	6-3/8"	Pkg. of 2
54437	437	1/4"	6"	6-1/2"	Pkg. of 2



Lubrication

DYNALINE Your Trusted Source.



The products above are also available in convenient and easy-to-stock kits.

See the Assortments Section in this catalogue for more information on these products.



Sizes are approximate. Specifications subject to change without notice.



Metric O-Rings

Buna N-70R Nitrile Durometer A.

Conforms to ASTM D2000 M2BF714, B14, EA14, EF11, EF21, EO14, EO34.

PART#	INSIDE DIAMETER	OUTSIDE DIAMETER	THICKNESS	QTY PER PKG.
54501	3 mm	7 mm	2 mm	Pkg. of 10
54502	5 mm	9 mm	2 mm	Pkg. of 10
54503	6 mm	10 mm	2 mm	Pkg. of 10
54504	8 mm	12 mm	2 mm	Pkg. of 10
54505	10 mm	14 mm	2 mm	Pkg. of 10
54506	13 mm	17 mm	2 mm	Pkg. of 10
54507	10 mm	15 mm	2.5 mm	Pkg. of 10
54508	12 mm	17 mm	2.5 mm	Pkg. of 10
54509	14 mm	19 mm	2.5 mm	Pkg. of 10
54510	15 mm	20 mm	2.5 mm	Pkg. of 10
54511	16 mm	21 mm	2.5 mm	Pkg. of 10
54512	19 mm	23 mm	2.5 mm	Pkg. of 10
54513	20 mm	25 mm	2.5 mm	Pkg. of 10
54514	21 mm	26 mm	2.5 mm	Pkg. of 10
54515	22 mm	27 mm	2.5 mm	Pkg. of 10
54516	18 mm	25 mm	3.5 mm	Pkg. of 10
54517	20 mm	27 mm	3.5 mm	Pkg. of 10
54518	22 mm	29 mm	3.5 mm	Pkg. of 10
54519	23 mm	30 mm	3.5 mm	Pkg. of 10
54520	25 mm	32 mm	3.5 mm	Pkg. of 10
54521	27 mm	34 mm	3.5 mm	Pkg. of 10
54522	28 mm	35 mm	3.5 mm	Pkg. of 10
54523	30 mm	37 mm	3.5 mm	Pkg. of 10
54524	31 mm	38 mm	3.5 mm	Pkg. of 10
54525	32 mm	39 mm	3.5 mm	Pkg. of 10
54526	34 mm	41 mm	3.5 mm	Pkg. of 10
54527	36 mm	43 mm	3.5 mm	Pkg. of 10
54528	38 mm	45 mm	3.5 mm	Pkg. of 10
54529	41 mm	48 mm	3.5 mm	Pkg. of 10
54530	44 mm	51 mm	3.5 mm	Pkg. of 10
54531	46 mm	53 mm	3.5 mm	Pkg. of 10
54532	50 mm	57 mm	3.5 mm	Pkg. of 10



Lubrication



High Pressure O-Rings

Buna N-90R Nitrile Durometer A, rigid material, stronger. Handles more pressure.

PART#	INDUSTRY NUMBER	THICKNESS	INSIDE DIAMETER	OUTSIDE DIAMETER	QTY PER PKG.
54901	901	1/16"	3/16"	5/16"	Pkg. of 10
54902	902	1/16"	1/4"	3/8"	Pkg. of 10
54903	903	1/16"	5/16"	7/16"	Pkg. of 10
54904	904	1/16"	11/32"	1/2"	Pkg. of 10
54905	905	1/16"	7/16"	9/16"	Pkg. of 10
54906	906	1/16"	15/32"	5/8"	Pkg. of 10
54907	907	1/16"	17/32"	11/16"	Pkg. of 10
54908	908	3/32"	21/32"	13/16"	Pkg. of 10
54909	909	3/32"	23/32"	29/32"	Pkg. of 10
54910	910	3/32"	3/4"	15/16"	Pkg. of 10
54911	911	1/8"	7/8"	1-3/32"	Pkg. of 10
54912	912	1/8"	15/16"	1-5/32"	Pkg. of 10
54913	913	1/8"	1"	1-7/32"	Pkg. of 10
54914	914	1/8"	1-1/16"	1-1/4"	Pkg. of 10
54916	916	1/8"	1-3/16"	1-3/8"	Pkg. of 10
54918	918	1/8"	1-3/8"	1-9/16"	Pkg. of 10
54920	920	1/8"	1-1/2"	1-3/4"	Pkg. of 10
54924	924	1/8"	1-3/4"	2"	Pkg. of 10
54928	928	1/8"	2-3/16"	2-3/8"	Pkg. of 10
54932	932	1/8"	2-3/8"	2-9/16"	Pkg. of 10



Lubrication

i Full product breakdown on page 22

Dynaline offers merchandisers for most products and we can help get your stock organized. We offer O-rings on a display merchandiser, as shown, or in tilt bin option.

00318K - O-Rings Merchandiser

PART#	CONTENTS
00318	O-Rings display board only, 24" x 24"
00318K	Full O-Rings merchandiser. Includes 00318 display board, 110 cornice hooks (65043) and the most popular products.

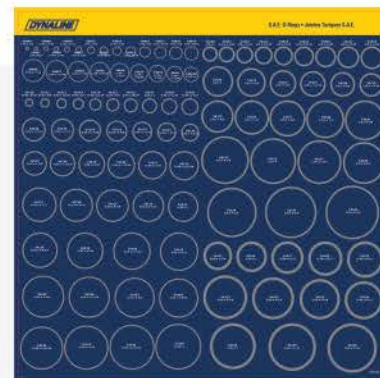

Sizes are approximate. Specifications subject to change without notice.



What is Nitrile (Buna-N NBR) ?

- Nitrile rubber is the general term for acrylonitrile butadiene terpolymer.
- The acrylonitrile content of the nitrile sealing compounds varies considerably (18% to 50%) and influences the physical properties of the finished material.
- The higher the acrylonitrile content, the better the resistance to oil and fuel.
- At the same time, elasticity and resistance to compression set is adversely affected. In view of these opposing realities, a compromise is often drawn, and a medium acrylonitrile content selected.
- Nitrile has good mechanical properties when compared with other elastomers and high wear resistance.
- Nitrile is not resistant to weathering and ozone.

Impermeability	G
Oil Resistance	E
Ozone Resistance	P
Set Resistance	GE
Tear Resistance	FG
Tensile Strength	GE
Water Resistance	FG
Weather Resistance	F
Abrasion Resistance	G
Acid Resistance	F
Chemical Resistance	FG
Cold Resistance	G
Dynamic Properties	GE
Electrical Properties	F
Flame Resistance	P
Heat Resistance	G

E - Excellent

G - Good

F - Fair

P - Poor

Heat Resistance:

Up to 212° F (100°C) with shorter life at 250°F (121°C).

Cold Flexibility:

Depending on individual compound, between -30°F and -70°F (-34°C and -57°C).

Chemical Resistance:

Aliphatic hydrocarbons (propane, butane, petroleum oil, mineral oil and grease, diesel fuel, fuel oils) vegetable and mineral oils and greases. HFA, HFB and HFC fluids. Dilute acids, alkali and salt solutions at low temperatures. Water (special compounds up to 212°F(100°C))

Not compatible with:

Fuels of high aromatic content (for flex fuels a special compound must be used). Aromatic hydrocarbons (benzene). Chlorinated hydrocarbons (trichlorethylene). Polar solvents (keytone, acetone, acetic acid, ethyleneester). Strong acids. Brake fluid with glycol base. Ozone, weather and atmospheric aging.

Sizes are approximate. Specifications subject to change without notice.

Legend:  12x24  24x24  Plan-0-Gram  Rack/End Cap  Funnel Tree  Other





ASSORTMENTS





A		N70 S.A.E. O-Ring Kit	211
Allen Cap Screw	199	N90 S.A.E. O-Ring Kit	212
Alligator Clip	200	O	
Assorted Grease Fittings Dynapaks	210	O-Ring	196
Auto Fuse	198, 203	O-Ring Flange Kit	210
Automotive Electric Repair Kit	195	P	
B		Plan-O-Gram	192
Body Shim	202	Q	
C		Quick Link	201
Clevis Pin	206,207	Quick Pin	209
Copper Washer	199	R	
Cotter Pin	196, 201	Retainer Ring	199, 205
D		Rivet	200
Dual Wall Adhesive	203, 204	Rubber Insulated Clamp	208
Dynakit Merchandiser	191	Rubber Sealing Washer	200
DynaKits	210	S	
Dynatray Merchandiser	191	S.A.E. Grease Fittings	193
E		SAE Hex Socket Set Screws	194
Electrical Clip	203	Snap Link	205
End Cap Display	192	Snap Link	205
External Retainer Ring	197	Solderless Terminal	204
G		Spring	195
Grease Fittings	193	Spring Pin	206
Grommet	198	Stainless Steel Cotter Pin	207
H		Standard Plug-In Fuses	194
Hair Pin	194, 197	U	
Heat Shrink Tube	201, 204	U-Clip and Screw	207
High Pressure O-Ring Kit	211	W	
High Temp V75 O-Ring Kit	212	Wire Connector	198
Hose Clamps	209	Wire Terminals	197
I		Woodruff Key	199
Industrial Shop	208		
Internal Retainer Ring	202		
J			
Japanese Metric O-Ring Kit	213		
K			
Keystock	202		
L			
Large Cotter Pin	206		
Lynch Pin	209		
M			
Merchandiser	191		
Metric Grease Fittings	193		
Mini Plug-In Fuses	194		
N			
N70 Metric O-Ring Kit	213		
N70 O-Ring Splicing Kit	213		





Dynaline Assortments Merchandisers

Dynaline offers merchandisers for almost every product. If you are ordering the products then you may be interested in the following Merchandisers.



Dynakit Assortments Merchandiser

Dynatray Assortments Merchandiser

PART#	CONTENTS
00296	Dynakits Display Board Only, 12" x 24"
00296K	Full Dynakits Merchandiser. Includes 00296 display board, 16 pegs (80004) and products.

PART#	CONTENTS
00031	Dynatrays Display Board Only, two - 24" x 24"
00031K	Full Dynatrays Merchandiser. Includes 00031A, 00031B display boards, 20 pegs (80004) and products.

i Full product breakdown on page 31

i Full product breakdown on page 31



Assortments Merchandiser

PART#	CONTENTS
01026	Assortments - 48"X72" Backdrop Does not include product
01026K	Assortments Merchandiser 48"x72". Includes header, and products listed below.

i Full product breakdown on page 32

Sizes are approximate. Specifications subject to change without notice.

Assortment End Cap Display

PART#	CONTENTS
100805	Display Only Includes Header Sign & Pegs
01024K	Assortments End Cap Display. Includes header, and products listed below.

i Full product breakdown on page 29



01024K

Assortments Plan-O-Gram

PART#	CONTENTS
01021	Assortments Backdrop Only, 48" x 48"
01021K	Full Assortments Plan-O-Gram. Includes 01021 and products.

i Full product breakdown on page 30

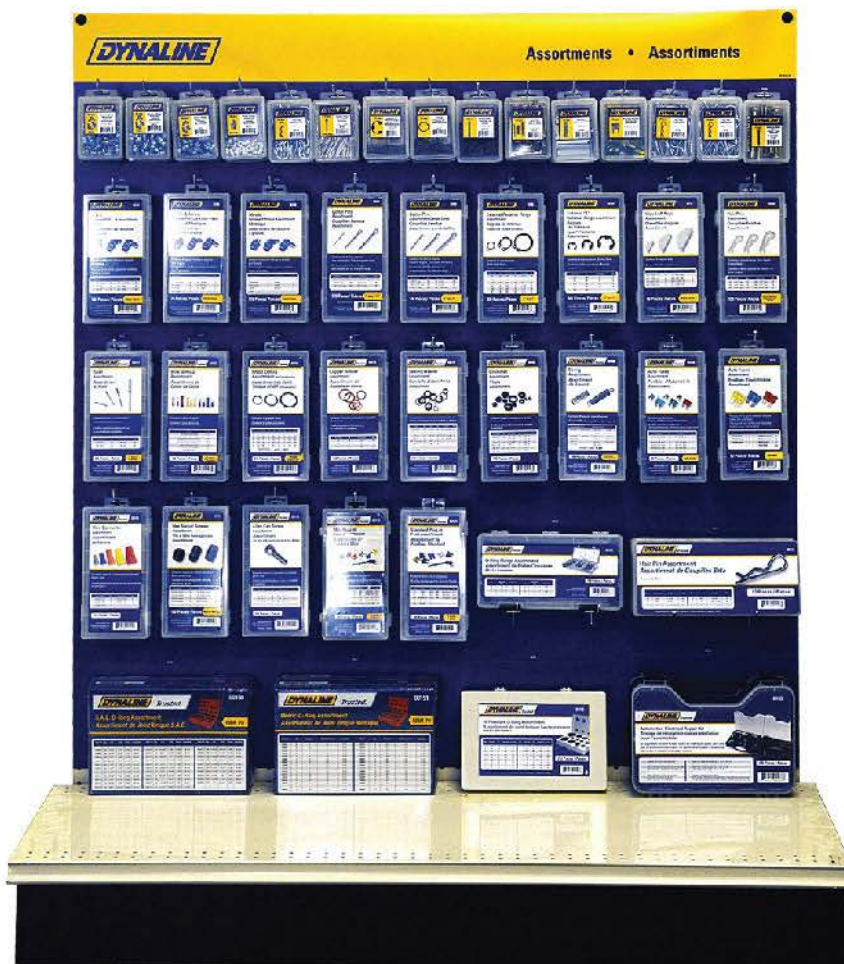

01021K



01021

Assortments

 **Part# 00108 - Metric Grease Fittings, 110 Pieces**
 9 popular sizes in a sturdy plastic case.

PART#	DESCRIPTION	QTY.	PART#	DESCRIPTION	QTY.
11100	Straight, M6	50	11119	90°, M8	5
11102	45°, M6	10	11120	Straight, M10	10
11104	90°, M6	10	11126	45°, M10	5
11105	Straight, M8	10	11127	90°, M10	5
11107	45°, M8	5			



 **Part# 10109 - Grease Fittings Assortments, 70 Pieces**
 9 popular sizes of S.A.E. and Metric grease fittings: 1/8" NPT, 1/4"-28, M6, M8 and M10, both in straight, 45° and 90° types.

PART#	DESCRIPTION	QTY.	PART#	DESCRIPTION	QTY.
11100	Straight, 1/8" NPT	10	11109	90°, 1/4"-28	5
11102	45°, 1/8" NPT	5	11114	Straight, M6	10
11104	90°, 1/8" NPT	5	11117	Straight, M8	5
11105	Straight, 1/4"-28	20	11120	Straight, M10	5
11107	45°, 1/4"-28	5			

*NPT - National Pipe Thread Taper



 **Part# 00112 - S.A.E. Grease Fittings Assortments, 100 Pieces**
 6 popular sizes in a sturdy plastic case.

PART#	DESCRIPTION	QTY.	PART#	DESCRIPTION	QTY.
11100	Straight, 1/8" NPT	20	11105	Straight, 1/4"-28	50
11102	45°, 1/8" NPT	5	11107	45°, 1/4"-28	10
11104	90°, 1/8" NPT	5	11109	90°, 1/4"-28	10

*NPT - National Pipe Thread Taper



Assortments



Sizes are approximate. Specifications subject to change without notice.



Part# 00113 - Hair Pin Assortments, 83 Pieces

6 popular sizes in a sturdy plastic case. Contents:

PART#	DESCRIPTION	QTY.	PART#	DESCRIPTION	QTY.
66301	3/32" x 1-11/16"	25	66305	5/32" x 3-5/16"	15
66302	3/16" x 3-1/4"	10	66306	1/8" x 2-5/8"	20
66304	3/16" x 3-1/4" Long	8	66308	1/4" x 4-1/4"	5



Part# 00119 - Mini Plug-In Fuses Assortments, 101 Pieces

The most popular sizes in a sturdy plastic case. Includes a fuse puller. Contents:

DESCRIPTION	QTY.	DESCRIPTION	QTY.
2A, 3A, 5A, 7.5A	5 ea.	15A	20
10A, 20A, 25A, 30A	15 ea.		



Part# 00121 Standard Plug-In Fuses Assortments, 101 Pieces

The most popular sizes in a sturdy plastic case. Includes a Fuse Puller. Contents:

DESCRIPTION	QTY.	DESCRIPTION	QTY.
3A, 5A, 7.5A, 25A	10 ea.	Fuse Puller	1
10A, 15A, 20A, 30A	15 ea.		



Part# 10119 - SAE Hex Socket Set Screws Assortments, 200 Pieces

12 most popular sizes of female Hex drive socket set screws. Black oxide finish
Contents:

DESCRIPTION	THREAD	QTY.	DESCRIPTION	THREAD	QTY.
5/32"x3/16"-32 Thread	Coarse	10	5/16"x1/2"-18 Thread	Coarse	20
5/16"x3/8"-18 Thread	Coarse	30	3/16"x1/4"-24 Thread	Coarse	10
3/8"x3/8"-16 Thread	Coarse	10	1/4"x3/8"-20 Thread	Coarse	20
1/8"x3/16"-40 Thread	Coarse	10	3/8"x3/8"-24 Thread	Fine	10
1/4"x1/4"-20 Thread	Coarse	30	5/16"x3/8"-24 Thread	Fine	20
3/8"x1/2"-16 Thread	Coarse	10	1/4"x1/4"-28 Thread	Fine	20

Sizes are approximate. Specifications subject to change without notice.





Part# 00133 - Automotive Electric Repair Kit, 285 Pieces

All the products needed for automotive electrical repairs, conveniently packed in a high impact plastic carry case.
 Contents:

DESCRIPTION	SPECIFICATIONS	QTY.
Crimping Tool	8-3/4" length	1
Voltage Tester	6V - 12V - 24V, DC	1
Electrical Tape Roll	10m, UL/CSA approved	1
Primary Wire Roll	1.5m	1
Screwdrivers	Phillips, Flat	2
Rubber Grommets	—	6
Cable Ties	30 of 4", 10 of 6", 10 of 7-1/2"	50
Test Leads	32"	2
Blade Fuses	1 each of 10A, 15A, 20A, 25A, 30A	5
Glass Fuses	1 each of 5A, 15A, 20A; 2 of 10A	5
Cable Clamps	10 of 1/8", 3 of 1/4"	13
Heat Shrink Tubes	6 of 3/16" x 1-1/2", 4 of 1/8" x 1/2"	10
Insulated Terminals	64 Round Rings, 40 Spades, 40 Butts, 27 Wire Connectors, 16 Lugs (M & F)	187
Carrying Case	High impact plastic, translucent lids	1



Part# 10100 - Spring Assortments, 200 Pieces

20 popular sizes of Compression and Expansion Springs.
 Contents:

DESCRIPTION	QTY.	DESCRIPTION	QTY.
Compression, 5/32" x 1/2"	10	Expansion, 3/16" x 1-3/4"	10
Compression, 5/32" x 3/4"	10	Expansion, 5/32" x 1-1/2"	10
Compression, 3/16" x 3/4"	10	Expansion, 5/32" x 2"	10
Compression, 7/32" x 11/16"	10	Expansion, 5/32" x 3-1/2"	10
Compression, 7/32" x 1-1/2"	10	Expansion, 13/64" x 13/16"	10
Compression, 1/4" x 13/32"	10	Expansion, 1/4" x 7/8"	10
Compression, 5/16" x 1-3/4"	10	Expansion, 5/16" x 1-1/8"	10
Compression, 23/64" x 1-3/8"	10	Expansion, 7/32" x 1"	10
Compression, 3/8" x 5/8"	10	Expansion, 11/32" x 1-27/32"	10
Expansion, 3/16" x 1-1/4"	10	Expansion, 11/32" x 1-7/16"	10



Sizes are approximate. Specifications subject to change without notice.





Assortments

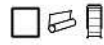

Part# 10101 - O-Ring Assortments, 270 Pieces

18 popular sizes of green HNBR O-Rings for air conditioning applications. Contents:



DESCRIPTION	IND#	QTY.	DESCRIPTION	IND#	QTY.
7/32" I.D. x 1/16" Thick	9	20	9/16" I.D. x 3/32" Thick	113	10
1/4" I.D. x 1/16" Thick	10	20	11/16" I.D. x 1/16" Thick	17	10
9/32" I.D. x 5/64" Thick	--	20	11/16" I.D. x 1/8" Thick	--	10
5/16" I.D. x 1/16" Thick	11	20	8 mm I.D. x 2 mm Thick	54504	20
5/16" I.D. x 5/64" Thick	--	20	10 mm I.D. x 2 mm Thick	54505	10
11/32" I.D. x 5/64" Thick	--	20	11 mm I.D. x 2 mm Thick	--	15
7/16" I.D. x 1/16" Thick	13	15	12 mm I.D. x 2 mm Thick	--	15
7/16" I.D. x 3/32" Thick	111	15	15 mm I.D. x 2 mm Thick	--	10
9/16" I.D. x 1/16" Thick	15	10	17 mm I.D. x 2 mm Thick	--	10

*HNBR - Hydrogenated Nitrile Butadiene Rubber



Part# 10102 - Cotter Pin Assortments, 560 Pieces

The 6 most popular sizes of Cotter Pins, from 1/16" to 5/32" in diameter.

Contents:



DESCRIPTION	QTY.	DESCRIPTION	QTY.
1/16" x 1" long	150	1/8" x 1-1/4" long	80
3/32" x 1" long	150	1/8" x 2" long	50
3/32" x 1-1/2" long	100	5/32" x 2-1/2" long	30



Part# 10103 - Cotter Pin (Large) Assortments, 150 Pieces

The 6 most popular sizes of Large Cotter Pins, from 1/8" to 5/16" in diameter.

Contents:



DESCRIPTION	QTY.	DESCRIPTION	QTY.
1/8" x 2" long	50	1/4" x 2" long	20
5/32" x 2-1/2" long	30	1/4" x 3" long	20
3/16" x 3" long	20	5/16" x 2-1/2" long	10

Sizes are approximate. Specifications subject to change without notice.

Part# 10105 - Hair Pin Assortments, 150 Pieces

The 6 most popular sizes of Hair Pins, from 3/32" to 5/32" in diameter.
 Contents:

DESCRIPTION	QTY.	DESCRIPTION	QTY.
3/32" x 1-3/16"	42	7/64" x 1-5/8"	25
5/64" x 1-5/16"	30	9/64" x 1-3/4"	20
5/64" x 1-9/16"	25	5/32" x 2-5/16"	8



Reference Chart Available
 See end of catalogue

Part# 10106 - External Retainer Ring Assortments, 300 Pieces

18 popular sizes of Snap Rings, from 1/8" to 1-1/4" in diameter.
 Contents:

DESCRIPTION	QTY.	DESCRIPTION	QTY.
5/32"	10	9/16"	15
3/16"	15	5/8"	20
1/8"	20	3/4"	25
5/16"	15	13/16"	15
1/4"	25	7/8"	20
3/8"	20	1"	15
7/16"	15	1-1/16"	15
15/32"	15	1-1/8"	10
1/2"	25	1-1/4"	5



Reference Chart Available
 See end of catalogue

Part# 10107 - Wire Terminals Assortments, 160 Pieces

The 8 most popular types of wire terminals: Ring, Male, Female, Splice, Spade, Butt, Bullet Male and Bullet Female.
 Contents:

DESCRIPTION	QTY.	DESCRIPTION	QTY.
Ring Terminals	50	Spade Terminals	10
Male Connectors	5	Butt Connectors	42
Female Disconnectors	5	Bullet Male Connector	20
Quick Splices	8	Bullet Female Disconnectors	20



Sizes are approximate. Specifications subject to change without notice.



Assortments



Part# 10108 - Grommet Assortments, 125 Pieces

18 popular sizes of solid & hollow grommets, from 1/8" to 1" in diameter.

Contents:

DESCRIPTION	QTY.	DESCRIPTION	QTY.
1/8" x 9/32"	15	1/2" x 21/32"	4
3/16" x 5/16"	10	5/8" x 1"	3
1/4" x 1/2"	7	3/4" x 15/16"	2
5/16" x 17/32"	3	Solid, 5/16"	20
3/8" x 1/2"	6	Solid, 3/8"	20
3/8" x 9/16"	5	Solid, 1/2"	10
3/8" x 3/4"	3	Solid, 5/8"	5
7/16" x 3/4"	3	Solid, 3/4"	4
Solid, 7/8"	3	Solid, 1"	2



Part# 10110 - Auto Fuses Assortment, 80 Pieces

Standard and Mini Fuses, from 5 to 30A.

Contents:

DESCRIPTION	QTY.	DESCRIPTION	QTY.
Standard, 5A, Orange	5	Mini, 5A, Orange	5
Standard, 10A, Red	10	Mini, 10A, Red	5
Standard, 15A, Blue	5	Mini, 15A, Blue	5
Standard, 20A, Yellow	10	Mini, 20A, Yellow	10
Standard, 25A, Clear	5	Mini, 25A, Clear	5
Standard, 30A, Green	10	Mini, 30A, Green	5



Part# 10111 - Wire Connector Assortments, 158 Pieces

5 popular sizes of Wire Connectors from 22 to 10 Gauge.

Contents:

DESCRIPTION	QTY.	DESCRIPTION	QTY.
22 Gauge, Grey	40	14 Gauge, Yellow	18
22 Gauge, Blue	40	10 Gauge, Red	10
16 Gauge, Orange	50		

Sizes are approximate. Specifications subject to change without notice.

Part# 10112 - Allen Cap Screw Assortments, 106 Pieces

9 popular sizes of Allen Cap Screws.
 Contents:

DESCRIPTION	QTY.	DESCRIPTION	QTY.
#8 - 32 x 1/2"	25	1/4" - 20 x 1"	10
#10 - 24 x 1/2"	25	5/16" - 18 x 1"	5
#10 - 24 x 1"	20	5/16" - 18 x 1-1/2"	5
1/4" - 20 x 1/2"	10	3/8" - 16 x 1"	3
		3/8" - 16 x 1-1/2"	3



Part# 10113 - Woodruff Key Assortments, 80 Pieces

The 8 most popular sizes of Woodruff Keys.
 Contents:

DESCRIPTION (THICKNESS X RADIUS X DIAMETER)	QTY.	DESCRIPTION (THICKNESS X RADIUS X DIAMETER)	QTY.
5/32" x 19/64" x 23/32"	10	1/8" x 1/4" x 5/8"	10
3/64" x 19/64" x 47/64"	10	5/32" x 1/4" x 39/64"	10
7/64" x 13/64" x 31/64"	10	13/64" x 11/32" x 53/64"	10
5/32" x 3/16" x 15/32"	10	15/64" x 23/64" x 53/64"	10



Part# 10114 - Copper Washer Assortments, 110 Pieces

6 popular sizes of Copper Washers, from 1/4" to 5/8" in diameter.
 Contents:

DESCRIPTION	QTY.	DESCRIPTION	QTY.
1/4"	30	7/16"	15
5/16"	25	1/2"	10
3/8"	20	5/8"	10



Part# 10104 - "E" Retainer Ring Assortments, 300 Pieces

9 popular sizes of External "E" Retainer Rings from 1/16" to 7/8" in diameter.
 Contents:

DESCRIPTION	QTY.	DESCRIPTION	QTY.
1/16"	30	1/2"	40
1/8"	30	5/8"	20
3/16"	40	3/4"	20
1/4"	50	7/8"	20
3/8"	50		



Assortments



Sizes are approximate. Specifications subject to change without notice.



Assortments



Part# 10115 - Rubber Sealing Washer Assortments, 141 Pieces

18 popular sizes of Rubber Sealing Washers. Safe for gasoline.
Contents:

DESCRIPTION	QTY.	DESCRIPTION	QTY.	DESCRIPTION	QTY.
Rubber		Fiber		Kingerit	
1/2" x 16	10	21 x 17	10	1-1/2"-27 x 38	3
3/4" - 15 x 24	10	1/2"	10	1/2"-12 x 18	10
1/2" x 10	5	3/8" x 8	10	1-1/4"-30 x 39	3
3/8" x 8	5	1"	5	3/4"-16 x 24	10
3/4"-11 x 24 x 2	10	3/4"	10		
3/8" x 10	5	3/8"	10		
1/2" x 17	10				
1/2"-9 x 19	5				



Part# 10117 - Rivet Assortments, 500 Pieces

125 pieces each of 1/8" Rivets in 4 popular lengths from 1/4" to 5/8".
Material: Steel with zinc plated finish.
Contents:

DESCRIPTION	QTY.	DESCRIPTION	QTY.
1/8" x 1/4"	125	1/8" x 5/8"	125
1/8" x 3/8"	125	1/8" x 5/16"	125



Part# 10118 - Fuse Assortments, 92 Pieces

15 Standard Fuses in 6 amperages each, plus a fuse puller and a 6-24V tester.
Contents:

DESCRIPTION	QTY.	DESCRIPTION	QTY.
Standard, 5A, Pink	15	Standard, 25A, Clear	15
Standard, 10A, Red	15	Standard, 30A, Green	15
Standard, 15A, Blue	15	Fuse Puller	1
Standard, 20A, Yellow	15	6-24V Tester	1



Part# 10120 - Alligator Clip Assortment 80 Pieces

40 black and 40 red alligator clips with plastic coated ends teeth cleanly cut and fit without overlay made of carbon steel with nickely plated finish content.

DESCRIPTION	QTY.
Red Alligator Clip Assortment	40
Black Alligator Clip Assortment	40

Sizes are approximate. Specifications subject to change without notice.



Part# 10121 - Heat Shrink Tube Assortment 171 Pieces

A shrinkable plastic tube used to insulate wires, providing abrasion resistance and environmental protection for stranded and solid wire conductors, connections, joints and terminals in electrical work.

DESCRIPTION	QTY.	DESCRIPTION	QTY.
Green 5/64" x 1-1/4"	25	White 15/64" x 2-1/4"	6
White 5/64" x 1-1/4"	25	Black 25/64" 4"	1
Red 5/64" x 1-1/4"	25	Green 15/32" x 3-1/2"	7
Black 5/64" x 1-1/4"	25	White 5/16" 3 -1/2"	11
Blue 5/32" x 2-1/4"	10	Blue 23/63" x 3-1/2"	11
Red 13/64" x 2-1/4"	8	Yellow 23/64" x 3-1/2"	7
Black 3/16" x 2-1/4"	10		



Part# 10122 - Cotter Pin Assortment 1000 Pieces

A metal fastener with two tines that are bent during installation used to fasten metal together, like with a staple or rivet.

DESCRIPTION	QTY.	DESCRIPTION	QTY.
1/16", 1" Long	380	1/8", 1-1/4" Long	115
3/32", 1" Long	240	1/8", 2" Long	75
3/32", 1" Long	140	5/32", 2-1/2" Long	50



Part# 10123 - Quick Link Assortment 20 Pieces

Ideal for quickly connecting chain, cable or rope without requiring tools.

DESCRIPTION	QTY.	DESCRIPTION	QTY.
1-3/8" x 11/16" x 1/8" dia.	6	2-9/16" x 1-1/4" x 1/4" dia.	2
1-5/8" x 3/4" x 3/16" dia.	4	1-15/16" x 7/8" x 3/16" dia.	4
3" x 1-5/16" x 5/16" dia.	2	2-1/4" x 1-1/16" x 1/4" dia.	2



Assortments

Sizes are approximate. Specifications subject to change without notice.





Part# 10124 - Internal Retainer Ring Assortment 300 Pieces

Internal retaining rings are placed into bores or housings to serve as points of attachment for parts of a machine assembly.

DESCRIPTION	QTY.	DESCRIPTION	QTY.
1/8"	20	9/16"	15
5/32"	10	5/8"	20
3/16"	15	3/4"	20
1/4"	25	13/16"	15
5/16"	15	7/8"	20
3/8"	20	1"	15
7/16"	15	1 - 1/16"	15
15/32"	15	1 - 1/8"	10
1/2"	25	1 - 1/4"	5



Part# 10125 - Keystock Assortment 60 Pieces

60 piece various keystock sizes content. This round ended feather key set is made of high quality stainless steel, rust-proof, wear-resistant, accurate, and smooth.

DESCRIPTION	QTY.	DESCRIPTION	QTY.
3 x 3 x 20mm	4	6 x 6 x 40mm	5
3 x 3 x 25mm	4	8 x 7 x 32mm	5
4 x 4 x 20mm	5	8 x 7 x 40mm	5
4 x 4 x 25mm	5	10 x 8 x 32mm	5
4 x 4 x 32mm	5	10 x 8 x 40mm	5
6 x 6 x 20mm	5	12 x 8 x 40mm	2
6 x 6 x 32mm	5		



Part# 10126 - Body Shim Assortment 144 Pieces

Rust and corrosion resistant zinc plated steel contents. Spacers for adjusting camber, caster and toe at the front or rear wheels.

DESCRIPTION	QTY.	DESCRIPTION	QTY.
1/64"	48	1/16"	24
1/32"	48	1/8"	24

Sizes are approximate. Specifications subject to change without notice.



Part# 10127 - Auto Fuse Assortment 49 Pieces

49 piece auto fuse assortment. Transparent for quick detection of blown fuse. Includes a safety clip clear plastic durable storage case.

DESCRIPTION	QTY.	DESCRIPTION	QTY.
5A	8	20A	8
10A	8	30A	8
15A	8	Safety Clip	1



Part# 10129 - Electrical Clip Assortment 28 Pieces

28 piece electrical clip. Each type has equal numbers of black and red spring clips. It contains PVC insulation.

DESCRIPTION	QTY.	DESCRIPTION	QTY.
2" Alligator Clip	6	1- 1/2" Alligator Clip	6
Mini Alligator Clip	10	30 AMP Charging Clip	2
25 AMP Charging Clip	2	10 AMP Charging Clip	2



Part# 10130 - Dual Wall Adhesive Assortment 42 Pieces

42 piece dual wall adhesive assortment. 3" long dual wall adhesive lined with heat shrink.

DESCRIPTION	QTY.	DESCRIPTION	QTY.
1/8" x 3" Long	15	3/8" x 3" Long	4
3/16" x 3" Long	10	1/2" x 3" Long	3
1/4" x 3" Long	8	3/4" x 3" Long	2



Assortments



Sizes are approximate. Specifications subject to change without notice.



Assortments



Part# 10131 - Dual Wall Adhesive Assortment 28 Pieces

28 piece dual wall adhesive assortment. 3" long dual wall adhesive lined with heat shrink.

DESCRIPTION	QTY.	DESCRIPTION	QTY.
1/8" x 3" Long	10	1/4" x 3" Long	4
3/16" x 3" Long	10	3/8" x 3" Long	4



Part# 10132 - Heat Shrink Tube Assortment 120 Pieces

120 piece heat shrink tube assortment. Color coded heat shrink tube in a clear and durable plastic case.

DESCRIPTION	QTY.	DESCRIPTION	QTY.
15/16" x 8" mm Black	15	3/16" x 4.75 mm Black	15
15/16" x 8" mm Blue	15	3/16" x 4.75 mm Red	15
9/32" x 7 mm Black	15	5/32" x 4.75 Black	15
9/32" x 7 mm Yellow	15	5/32" x 4.75 Green	15



Part# 10133 - Solderless Terminal Assortment 305 Pieces

305 piece solderless terminal assortment. This pack features the most commonly used connectors.

DESCRIPTION	COLOUR	QTY.
12-10 AWG Ring Terminal #6	Yellow	10
16-14 AWG Ring Terminal #8	Blue	20
16-14 AWG Ring Terminal #10	Blue	20
12-10 AWG Butt Connector	Yellow	10
16-14 AWG Butt Connector	Blue	20
22-16 AWG Female Disconnecter	Red	35
22-16 AWG Male Disconnecter	Red	35
18-14 AWG Quick Splice Connector	Blue	4
1/8" Cable Clamp	White	15
8" Crimper Tool	Red	1
5/64" x 3-1/8" Cable Ties	Clear	100
1/4" Grommets	Black	30

Sizes are approximate. Specifications subject to change without notice.

Part# 10135 - Snap Link Assortment 12 Pieces

12 piece the Aluminum D-Ring assortment. Made with rust and corrosion resistant anodized material for longevity.

DESCRIPTION	QTY.	DESCRIPTION	QTY.
3 - 1/8" Red	2	2 - 3/8" Silver	2
2 - 3/4" Purple	4	3 - 1/8" Blue	4



Part# 10136 - Snap Link Assortment 20 Pieces

20 piece the Aluminum D-Ring assortment. Made with rust and corrosion resistant anodized material for longevity.

DESCRIPTION	QTY.	DESCRIPTION	QTY.
3 - 1/8" Red	2	2 - 3/8" Silver	4
2 - 3/4" Purple	4	2" Blue	10



Part# 10137 - Retainer Ring Assortment 225 Pieces

225 retainer ring assortment. Made with tempered spring steel internal and external retainer ring. Covered in durable black oxide finish.

INTERNAL	QTY.	EXTERNAL	QTY.	EXTERNAL	QTY.
7/16"	15	1/4"	15	5/8"	15
1/2"	10	5/16"	15	3/4"	15
9/16"	10	3/8"	15	13/16"	15
5/8"	15	7/16"	15	7/8"	10
3/4"	10	1/2"	15	1"	10
13/16"	5	9/16"	15	1-1/4"	5



Assortments



Sizes are approximate. Specifications subject to change without notice.



Part# 10138 - Spring Pin Assortment 120 Pieces

120 piece spring pin assortment tube assortment. Made of spring steel for flexibility and a balance of strength and toughness. Comes in a compartmented plastic case for organized storage.

DESCRIPTION	QTY.	DESCRIPTION	QTY.	DESCRIPTION	QTY.
3/8" x 3/4"	2	3/32" x 1"	4	1/4" x 1-3/4"	4
3/8" x 1-1/2"	2	3/32" x 1-1/4"	4	5/16" x 3/4"	4
3/8" x 2"	2	5/32" x 5/8"	4	5/16" x 1-1/2"	4
1/16" x 3/16"	2	5/32" x 1"	4	5/16" x 2"	4
1/16" x 5/16"	4	5/32" x 1-1/2"	4	1/8" x 5/8"	5
1/16" x 3/4"	4	7/32" x 5/8"	4	1/8" x 1"	5
5/64" x 1/4"	4	7/32" x 1-1/4"	4	1/8" x 1-1/4"	5
5/64" x 1/2"	4	7/32" x 1-3/4"	4	3/16" x 5/8"	5
5/64" x 1"	4	1/4" x 5/8"	4	3/16" X 1"	5
3/32" x 5/8"	4	1/4" x 1-1/4"	4	3/16" X 1-1/4"	5



Part# 10139 - Large Cotter Pin Assortment 100 Pieces

100 piece large cotter pin assortment. Manufactured with steel construction for durability.

DESCRIPTION	QTY.
1/8" x 2" Long	50
5/32" x 2-1/2" Long	30
3/16" x 3" Long	20



Part# 10140 - Clevis Pin Assortment 60 Pieces

60 piece clevis pin assortment pack. Contains 21 popular sizes. Comes with zinc plating.

3/32" PIN HOLE	QTY.	1/8" PIN HOLE	QTY.	5/32" PIN HOLE	QTY.
3/16" x 1"	4	3/8" x 3/4"	2	3/8" x 3/4"	2
1/4" x 1"	4	3/8" x 1-1/2"	2	3/8" x 1-1/2"	2
1/4" x 1-1/4"	3	3/8" x 2"	2	3/8" x 2"	2
1/4" x 1-1/2"	4	1/16" x 3/16"	2	1/16" x 3/16"	2
1/4" x 1-3/4"	3	1/16" x 5/16"	4	1/16" x 5/16"	4
1/4" x 2"	3	1/16" x 3/4"	4		
1/4" x 2-1/4"	3	5/64" x 1/4"	4		
1/4" x 2-1/2"	3	5/64" x 1/2"	4		

Sizes are approximate. Specifications subject to change without notice.



Part# 10141 - Clevis Pin Assortment 20 Pieces

20 piece clevis pin assortment pack. Comes with zinc plating.,

3/32" PIN HOLE	QTY.	1/8" PIN HOLE	QTY.	5/32" PIN HOLE	QTY.
1/4" x 1-1/4"	1	5/16" x 1"	1	3/8" x 1	1
1/4" x 1/2"	2	5/16" x 1-1/4"	1	3/8" x 2"	2
1/4" x 2"	1	5/16" x 1-1/2"	2	3/8" x 2-3/8"	1
		5/16" x 2"	2		
		5/16" x 2-1/4"	2		
		5/16" x 2-1/2"	2		
		5/16" x 3"	2		



Part# 10142 - U-Clip and Screw Assortment 170 Pieces

170 piece U-Clip and Screw assortment. Screws and U-Clips are made with corrosion resistant zinc plated steel with black oxide finish.

SLOTTED SCREWS	QTY.	U-CLIPS	QTY.
#6 x 5/16"	40	#6	20
#10 x 1/2"	15	#6 with notch	20
#8 x 5/8"	20	#8	20
1/4" x 3/4"	10	#10	15
		1/4"	10



Part# 10143 - Stainless Steel Cotter Pin Assortment 555 Pieces

555 piece stainless steel cotter pin assortment. Use to lock clevis pins, slotted nuts, and other fasteners. Length is measured from under the head to the end of the short shank.

DESCRIPTION	QTY.	DESCRIPTION	QTY.
1/6", 1" Long	380	1/8", 1-1/4" Long	115
3/32", 1" Long	240	1/8", 2" Long	75
3/32", 1-1/2" Long	140	5/32", 2-1/2" Long	50



Sizes are approximate. Specifications subject to change without notice.





Assortments



Part# 10144 - Industrial Shop Assortment 295 Pieces

295 piece industrial shop assortment. Comes with retainer rings, woodruff keys, spring pins and more.

DESCRIPTION	QTY.
External Retainer Rings	48
E-Clip Retainer Rings	40
Spring Pin	72
Woodruff Key	135



Part# 10145 - Quick Splice Connector Assortment 65 Pieces

65 piece quick splice connector assortment. Made with durable polypropylene material body.

DESCRIPTION	QTY.	DESCRIPTION	QTY.
18-24 Gauge Dark Blue	20	18-17 Gauge Blue	20
22-18 Gauge Red	20	12-10 Gauge Yellow	5



Part# 10147 - Rubber Insulated Clamp Assortment 42 Pieces

42 piece rubber insulated clamp assortment. This clamp is made of corrosion and rust resistant zinc plated steel.

DESCRIPTION	QTY.	DESCRIPTION	QTY.
1/4"	20	1/2"	4
5/16"	8	5/8"	4
3/8"	6		

Sizes are approximate. Specifications subject to change without notice.



Part# 10148 - Lynch Pin Assortment 50 Pieces

50 piece lynch pin assortment. Lynch pins are self-locking; can be used in place of R pin. Use with tractors, automobiles, grills and other heavy equipment.

DIAMETER, QTY.	LENGTH	QTY.
3/16"	1 - 7/16"	18
1/4"	1 - 3/4"	18
5/16"	1 - 3/4"	6
7/16"	1 - 3/4"	8



Part# 10149 - Quick Pin Assortment 20 Pieces

20 piece quick pin assortment. A lock pin with an attached wire loop is perfect for quick release applications. It is easy and quick to use.

DIAMETER, QTY.	SHAPE	QTY.
1/4"	Round	10
3/8"	Round	5
5/16"	Square	5



Part# 10150 - Hose Clamps Assortment 34 Pieces

34 piece hose clamps assortment. Worm gear type hose clamps made with zinc plated finish.

SIZE	QTY.	SIZE	QTY.
5/8"	8	1-1/4"	4
3/4"	8	1"	4
7/8"	3	1-1/16"	4





Assortments



00140



00179



00180



11135A



11136A

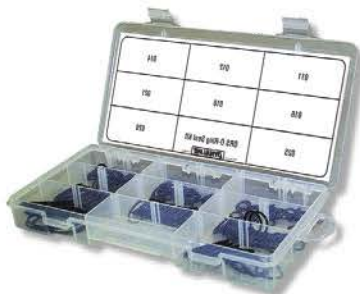

DynaKits

Retail assortments of our most popular items with hanging tab and positive locking closures. Made of durable, transparent polypropylene.

PART#	CONTENTS	QTY.
00140	Standard Plug-In Fuses	50 pcs. / 5 sizes
00141	Mini Plug-In Fuses	50 pcs. / 5 sizes
00160	Cotter Pins (Small)	215 pcs. / 8 sizes
00161	Cotter Pins (Large)	40 pcs. / 12 sizes
00163	S.A.E. Grease Fittings	40 pcs. / 6 sizes
00164	Hair Pins	28 pcs. / 8 sizes
00173	Spring Pins	62 pcs. / 13 sizes
00174	Woodruff Keys	40 pcs. / 12 sizes
00175	"E" Retainer Rings	70 pcs. / 7 sizes
00176	Internal Retainer Rings	55 pcs. / 11 sizes
00177	External Retainer Rings	70 pcs. / 14 sizes
00178	Clevis Pins	23 pcs. / 14 sizes
00179	S.A.E. O-Rings	95 pcs. / 15 sizes
00180	Keystock	30 pcs. / 5 sizes
00181	Metric Grease Fittings	50 pcs. / 7 sizes
00182	Drive-In Grease Fittings	50 pcs. / 4 sizes
00189	Universal Clevis Pins	11 pcs. / 9 sizes

Assorted Grease Fittings Dynapak

The most popular sizes and types, in a convenient retail package.

PART#	CONTENTS	QTY.
11135A	S.A.E. Grease Fittings	10 pcs. / 5 sizes
11136A	Metric Grease Fittings	10 pcs. / 6 sizes

Part# 00157 - O-Ring Flange Kit, 150 Pieces

8 sizes of Buna-N 90 durometer O-Ring Seals in a transparent plastic box with dividers and hanging tab.

Contents:

IND#	QTY.	IND#	QTY.
011	25	018	20
012	25	021	15
014	25	025	10
016	20	029	10

Sizes are approximate. Specifications subject to change without notice.



 **Part# 00150 - N70 S.A.E. O-Ring Kit, 407 Pieces**

32 sizes of Buna-N 70 durometer O-Rings in a plastic box with thickness gauge.
 Contents:

PART#	IND#	QTY.	LOC.	PART#	IND#	QTY.	LOC.	PART#	IND#	QTY.	LOC.
54006	6	20	R-01	54115	115	13	R-12	54217	217	10	R-23
54008	8	20	R-02	54116	116	13	R-13	54218	218	10	R-24
54010	10	20	R-03	54117	117	13	R-14	54219	219	10	R-25
54011	11	20	R-04	54118	118	13	R-15	54220	220	10	R-26
54012	12	20	R-05	54210	210	10	R-16	54221	221	10	R-27
54014	14	20	R-06	54211	211	10	R-17	54222	222	10	R-28
54110	110	13	R-07	54212	212	10	R-18	54223	223	10	R-29
54111	111	13	R-08	54213	213	10	R-19	54224	224	10	R-30
54112	112	13	R-09	54214	214	10	R-20	54225	225	10	R-31
54113	113	13	R-10	54215	215	10	R-21	54226	226	10	R-32
54114	114	13	R-11	54216	216	10	R-22				



 **Part# 00151 - N70 Metric O-Ring Kit, 419 Pieces**

32 sizes of Buna-N 70 durometer Metric O-Rings in a lockable plastic box.
 Contents:

PART#	I.D. (MM)	QTY.	LOC.	PART#	I.D. (MM)	QTY.	LOC.	PART#	I.D. (MM)	QTY.	LOC.
54501	3	20	R-01	54512	18	14	R-12	54523	30	10	R-23
54502	4.4	20	R-02	54513	19	13	R-13	54524	31	10	R-24
54503	5	18	R-03	54514	21	14	R-14	54525	33	10	R-25
54504	7	23	R-04	54515	22	13	R-15	54526	34.5	10	R-26
54505	10	23	R-05	54516	18	10	R-16	54527	36	10	R-27
54506	13	23	R-06	54517	20	10	R-17	54528	38	10	R-28
54507	10	14	R-07	54518	22	10	R-18	54529	41	10	R-29
54508	11	13	R-08	54519	23.5	10	R-19	54530	44	10	R-30
54509	13	14	R-09	54520	25	10	R-20	54531	47	10	R-31
54510	14	13	R-10	54521	26.5	10	R-21	54532	50	10	R-32
54511	16	14	R-11	54522	28	10	R-22				



 **Part# 00152 - High Pressure O-Ring Kit, 212 Pieces**

20 sizes of Buna-N 90 durometer O-Rings (Nitrile Durometer A) in a plastic box.
 Contents:

PART#	I.D. (MM)	QTY.	LOC.	PART#	I.D. (MM)	QTY.	LOC.	PART#	I.D. (MM)	QTY.	LOC.
54901	0.185	10	901	54910	0.755	12	910	54912	0.924	10	912
54902	0.239	10	902	54911	0.863	10	911	54913	0.986	10	913
54903	0.301	10	903	54912	0.924	10	912	54914	1.047	10	914
54904	0.351	10	904	54913	0.986	10	913	54916	1.171	10	916
54905	0.414	12	905	54914	1.047	10	914	54918	1.355	10	918
54906	0.468	12	906	54908	0.644	12	908	54920	1.475	10	920
54907	0.530	12	907	54909	0.706	12	909	54924	1.720	10	924
54908	0.644	12	908	54910	0.755	12	910	54928	2.090	10	928
54909	0.706	12	909	54911	0.863	10	911	54932	2.337	10	932



LOC. = LOCATION

Sizes are approximate. Specifications subject to change without notice.





Assortments



□ Part# 00153 - High Temp V75 O-Ring Kit, 382 Pieces

30 sizes of Viton 75 O-Rings, High Temp: -25°C to 200°C. In a plastic box with thickness gauge. Contents:

O.D.	I.D.	QTY.	LOCATION	O.D.	I.D.	QTY.	LOCATION
1/4"	1/8"	20	6	3/4"	9/16"	13	113
9/32"	5/32"	20	7	3/16"	5/8"	13	114
5/16"	3/16"	20	8	7/8"	11/16"	13	115
11/32"	7/32"	20	9	15/16"	3/4"	13	116
3/8"	1/4"	20	10	1"	3/4"	10	210
7/16"	5/16"	20	11	1-1/16"	13/16"	10	211
1/2"	3/8"	20	12	1-1/8"	7/8"	10	212
9/16"	3/8"	13	110	1-3/16"	15/16"	10	213
5/8"	7/16"	13	111	1-1/4"	1"	10	214
11/16"	1/2"	13	112	15/16"	11/16"	10	215
3/4"	9/16"	13	113	1-3/8"	1-1/8"	10	216
3/16"	5/8"	13	114	1-9/16"	1-3/16"	10	217
7/8"	11/16"	13	115	1-1/2"	1-1/4"	10	218
15/16"	3/4"	13	116	1-3/16"	15/16"	10	219
1"	3/4"	10	210	1-5/8"	1-3/8"	10	220
1-1/16"	13/16"	10	211	1-1/2"	1-1/16"	10	221
1-1/8"	7/8"	10	212	1-3/4"	1-1/2"	10	222
1-3/16"	15/16"	10	213	1-7/8"	1-1/2"	7	325
1-1/4"	1"	10	214	2"	1-5/8"	7	326
15/16"	11/16"	10	215	2-1/8"	1-3/4"	7	327

□ Part# 00154 - N90 S.A.E. O-Ring Kit, 382 Pieces

30 sizes of Buna-N 90 durometer O-Rings in a plastic box with thickness gauge. Contents:



O.D.	I.D.	QTY.	LOCATION	O.D.	I.D.	QTY.	LOCATION
1/4"	1/8"	20	6	1-1/16"	13/16"	10	211
9/32"	5/32"	20	7	1-1/8"	7/8"	10	212
5/16"	3/16"	20	8	1-3/16"	15/16"	10	213
11/32"	7/32"	20	9	1-1/4"	1"	10	214
3/8"	1/4"	20	10	15/16"	11/16"	10	215
7/16"	5/16"	20	11	1-3/8"	1-1/8"	10	216
1/2"	3/8"	20	12	1-9/16"	1-3/16"	10	217
9/16"	3/8"	13	110	1-1/2"	1-1/4"	10	218
5/8"	7/16"	13	111	1-3/16"	15/16"	10	219
11/16"	1/2"	13	112	1-5/8"	1-3/8"	10	220
3/4"	9/16"	13	113	1-1/2"	1-1/16"	10	221
3/16"	5/8"	13	114	1-3/4"	1-1/2"	10	222
7/8"	11/16"	13	115	1-7/8"	1-1/2"	7	325
15/16"	3/4"	13	116	2"	1-5/8"	7	326
1"	3/4"	10	210	2-1/8"	1-3/4"	7	327

Buna-N Rubber is also referred to as Nitrile Rubber. Nitrile rubber is a copolymer of butadiene and acrylonitrile. In addition to its excellent elastomeric properties, it is resistant to oil, caustics, and aliphatic hydrocarbons. Nitrile is not suitable for solvents and chlorinated hydrocarbons. Its maximum temperature limit is 212° F.

Viton is a brand of synthetic rubber and fluoropolymer elastomer commonly used in O-rings and other molded or extruded goods. Viton fluoroelastomers are categorized under the ASTM D1418 and ISO 1629 designation of FKM. This class of elastomers is a family comprising copolymers of hexafluoropropylene (HFP) and vinylidene fluoride (VDF or VF2), terpolymers of tetrafluoroethylene (TFE), vinylidene fluoride (VDF) and hexafluoropropylene (HFP) as well as perfluoromethylvinylether (PMVE) containing specialties. The fluorine content of the most common Viton grades varies between 66 and 70%.

Sizes are approximate. Specifications subject to change without notice.

Part# 00155 - N70 O-Ring Splicing Kit, 5 Pieces

5 sizes of Buna-N 70 durometer O-Rings. Cords and all the tools required to produce a perfect O-Ring, in a lockable plastic box. Contents:

DESCRIPTION	LENGTH	DESCRIPTION	LENGTH
1/16" O-Ring Cord	3 ft.	9/32" O-Ring Cord	3 ft.
3/32" O-Ring Cord	3 ft.	Splicing/ Cutting Tool	1
1/8" O-Ring Cord	3 ft.	Cyanocrylate Super Glue, 2g	1
7/32" O-Ring Cord	3 ft.	Razor blade	1



Part# 00156 - Japanese Metric O-Ring Kit, 380 Pieces

36 sizes of Buna-N 70 durometer JIS-2401* Metric O-Rings in a plastic box. Contents:

IND#	SIZE	QTY.	IND#	SIZE	QTY.	IND#	SIZE	QTY.
P3	2.8x1.9	25	P12.5	12.3x2.4	12	P24	23.7x3.5	7
P4	3.8x1.9	20	P14	13.8x2.4	12	V24	23.5x4	6
P5	4.8x1.9	20	P15	14.8x2.4	12	P25	24.7x3.5	7
P6	5.8x1.9	20	P16	15.8x2.4	12	P25.5	25.2x3.5	7
P7	6.8x1.9	15	V15	14.5x4	4	P26	25.7x3.5	7
P8	7.8x1.9	15	P18	17.8x2.4	8	P28	27.7x3.5	7
P9	8.8x1.9	15	P20	19.8x2.4	8	G30	29.4x3.1	7
P10	9.8x1.9	15	P21	20.8x2.4	8	P29	28.7x3.5	6
P10A	9.8x2.4	15	P22	21.8x2.4	8	P29.5	29.2x3.5	6
P11	10.8x2.4	15	P22A	21.7x3.5	5	P30	29.7x3.5	6
P11.2	11x2.4	15	P22.4	22.1x3.5	5	P31	30.7x3.5	6
P12	11.8x2.4	12	G25	24.4x3.1	6	P31.5	31.2x3.5	6

* Japanese Industrial Standard (JIS) 2401 "O-rings." The classification system recommended by this standard is twofold, by material and by size and use.



Part# 00158 - N70 Metric O-Ring Kit, 425 Pieces

30 sizes of Buna-N 70 durometer Metric O-Rings in a plastic box with dividers and transparent lid. Contents:

SIZE	QTY.	SIZE	QTY.	SIZE	QTY.
3.0 x 1.5	20	6.3 x 2.4	15	10.0 x 3.0	10
5.0 x 1.5	20	8.3 x 2.4	15	12.0 x 3.0	10
7.0 x 1.5	20	11.3 x 2.4	15	14.0 x 3.0	10
9.0 x 1.5	20	13.3 x 2.4	15	16.0 x 3.0	10
11.0 x 1.5	20	17.7 x 2.4	15	18.0 x 3.0	10
6.0 x 2.0	20	5.0 x 2.5	15	20.2 x 3.0	5
8.0 x 2.0	20	7.0 x 2.5	15	22.2 x 3.0	5
10.0 x 2.0	20	10.0 x 2.5	15	24.2 x 3.0	5
12.0 x 2.0	20	12.0 x 2.5	15	26.2 x 3.0	5
14.0 x 2.0	20	15.0 x 2.5	15	30.2 x 3.0	5



Sizes are approximate. Specifications subject to change without notice.





CARGO CONTROL



A		Tow Ropes	221
Anchor Points	224	Truck Winch Straps	221
Anchor Rings	224	W	
B		Wheel Chocks	227
Bungee Cord Hooks	217	Wheel Chocks	227
Bungee Cord Reels	217	Wheel Chocks	227
C		White Recovery Straps	221
Cable Type Load Binder Locks	226	Winch Bars	223
Cam Strap Four Packs	219		
Cam Straps	219		
Cargo Control Plan-O-Gram	216		
Cargo Nets	217		
Cargo Winch	223		
Corner Protector	224		
E			
Elastic Tie Down Strap	217		
EPDM Rubber Tarp Straps	218		
F			
Foldable Handle Ratchet Load Binders	225		
Fold-Over Handle Load Binders	226		
H			
H.D. Trailer & RV Wheel Chock	227		
Hand Winch - Dual Drive	222		
Hand Winches - General Purpose	222		
Hand Winches - Worm Gear	223		
Heavy Duty Recessed Anchor Rings	224		
Heavy Duty Thermoplastic Tarp Straps	218		
Heavy Duty Tow Ropes	221		
L			
Load Binder Locks	225		
Load Binder/Cable Puller Rack	216		
Load Tighteners	225		
Locking Ratchet Racks	226		
M			
Mud Flaps	227		
R			
Ratchet Straps	219		
Ratchet Straps	220		
Ratchet Straps with Flat Hooks	220		
Ratchet Straps with S-Hooks	219		
Ratchet Straps with S-Hooks	220		
Ratchet Straps with S-Hooks	220		
Ratchet Type Load Binders	225		
Recessed Anchor Rings	224		
Recoilless Load Binders	225		
T			
Tarp Strap Replacement Hook	218		





Your Trusted Source.

Dynaline Cargo Control Merchandisers

Dynaline offers merchandisers for almost every product. Merchandisers keep your stock organized, visible and easy to shop.

Cargo Control



*Retail hanging pegs not provided



Cargo Control Plan-0-Gram

PART#	CONTENTS
01052	Cargo Control Backdrop Only , 48" x 48"
01052K	Full Cargo Control Plan-o-gram. Includes 01052 and products.

i Full product breakdown on page 33

Load Binder/Cable Puller Rack

PART#	CONTENTS
70098	Load Binder Rack Only , 24" wide x 31.8" high x 20.6" deep
70098K	Full Cable Pullers & Load Binder Rack. Includes 24" x 24" Display Board and the products.

i Full product breakdown on page 33

Sizes are approximate. Specifications subject to change without notice.



Cargo Control

Bungee Cord Reels

Industrial quality, black polyester sheath with rubber core in a plastic reel.

PART#	DIAMETER	CORD LENGTH	LOAD RATED
11176	1/4"	216' (65.8 m)	55-66 lb
11177	5/16"	216' (65.8 m)	66-77 lb
11178	3/8"	200' (61 m)	77-88 lb



Bungee Cord Hooks

Fits 1/4", 5/16" and 3/8" Bungee Cords.

PART#	DESCRIPTION
11174	Fits 1/4", 5/16" and 3/8" Bungee Cords. Vinyl-coated wire hook. Wire diameter 4 mm. 10 per pkg.



Cargo Nets

Keeps smaller items stationary while driving. Elastic cords & plastic hooks.

PART#	SIZE	PKG. QTY.
12302	36" x 48"	1 ea.
12303	72" x 96" (Pick-Up)	1 ea.



Your Trusted Source.

Ratchet Straps

- Keep cargo safe and secure during transport
- Designed for quick and easy operation
- Spring-loaded ratchet buckles tension and releases loads
- High quality, weather-resistant webbing with secure stitching.



Elastic Rubber Tie Down Strap

Red tie down straps with two molded hooks. 10 Pieces per polybag.

PART#	HOOKS SIZE	LENGTH	WIDTH
11290	2.4" X 1.7"	22"	0.40"



Sizes are approximate. Specifications subject to change without notice.





Heavy Duty Thermoplastic Tarp Straps

These brand new Heavy Duty tarp straps are made from thermoplastic rubber and supplied with two crimped zinc plated S-hooks which means more load capacity.

PART#	LENGTH	CAPACITY	HOOKS	PKG. QTY.
11295	Heavy Duty 9"	90 lb	S Hooks	10/pkg.
11296	Heavy Duty 15"	90 lb	S Hooks	10/pkg.
11297	Heavy Duty 21"	90 lb	S Hooks	10/pkg.
11298	Heavy Duty 31"	90 lb	S Hooks	10/pkg.



EPDM Rubber Tarp Straps

100% EPDM. (See chart below.) Recommended for commercial and industrial applications. Supplied with two zinc plated S-hooks assembled.

PART#	LENGTH	CAPACITY	QTY.
11191	9"	50 lb	10/pkg.
11192	15"	50 lb	10/pkg.
11193	21"	50 lb	10/pkg.
11194	31"	50 lb	10/pkg.
11299	31" adjustable	50 lb	10/pkg.

11191-11194



11299

EPDM (Ethylene Propylene, EPM)

EPM is a copolymer of ethylene and propylene. Ethylene-propylene-diene rubber (EPDM) is produced using a third monomer and is particularly useful when sealing phosphate-ester hydraulic fluids and in brake systems that use fluids having a glycol base.

Heat Resistance:

- ▶ Up to 300° F (149°C) (max. 400° F (204°C) in water and/or steam).

Cold Flexibility:

- ▶ Down to approximately -70°F (-57°C).

Chemical Resistance:

- ▶ Hot water and steam up to 300° F (149°C) with special compounds up to 400° F (204°C).
- ▶ Glycol based brake fluids up to 300° F (149°C).
- ▶ Many organic and inorganic acids.
- ▶ Cleaning agents, soda and potassium alkalis.
- ▶ Phosphate-ester based hydraulic fluids (HFD-R).
- ▶ Silicone oil and grease.
- ▶ Many polar solvents (alcohols, ketones, esters).
- ▶ Ozone, aging and weather resistant.

Not compatible with:

- ▶ Mineral oil products (oils, greases and fuels).

Property EPDM

Abraison Resistance	GE
Acid Resistance	G
Chemical Resistance	E
Cold Resistance	GE
Dynamic Properties	GE
Electrical Properties	G
Flame Resistance	P
Heat Resistance	E
Impermeability	G
Oil Resistance	P
Ozone Resistance	E
Set Resistance	GE
Tear Resistance	GE
Tensile Strength	GE
Water Resistance	E
Weather Resistance	E

E - Excellent F - Fair
G - Good P - Poor

Tarp Strap Replacement Hook

Clear zinc plated finish



PART#	DESCRIPTION	LENGTH	QTY.
66241	3/16" wire diameter S-Hook	3"	10/pkg.

Reference Chart Available



See end of catalogue

Sizes are approximate. Specifications subject to change without notice.

Cam Straps

Designed for quick and easy operation. High quality, weather-resistant webbing with secure stitching. Vinyl-coated, heat-treated steel hooks.

- Die cast cam buckle.
- One piece per clamshell package.

PART#	SIZE	W.L.L.	U.L.L.	COLOUR	WEBBING
 11182	1" x 6'	400 lb	1,200 lb	Blue	Polyester
 11185	1" x 10'	400 lb	1,200 lb	Blue	Polyester



Cam Strap Four Packs

Four Cam Straps in a clamshell package.



PART#	SIZE	W.L.L.	U.L.L.	COLOUR	WEBBING
12331	1" x 6'	250 lb	750 lb	Red	Polyester
12332	1" x 6'	250 lb	750 lb	Black	Polyester



Ratchet Straps with S-Hooks (Vinyl-Coated)







Designed for quick and easy operation. High quality, weather-resistant webbing with secure stitching and steel ratchet.

- High Carbon Steel Ratchet.
- One piece per retail package.

PART#	SIZE	W.L.L.	U.L.L.	COLOUR	WEBBING
 11183	1" x 15'	400 lb	1,200 lb	Blue	Polyester
12206	1" x 15'	166 lb	500 lb	Red	Polypropylene
 12207	1" x 15'	166 lb	500 lb	Black	Polypropylene
11184	1" x 20'	1,000 lb	3,000 lb	Yellow	Polyester



Ratchet Straps - Double "J" Hooks - Retail Package

PART#	SIZE	W.L.L.	U.L.L.	COLOUR	WEBBING
*12229	1" x 6'	400lb	1,200lb	Yellow	Polyester
 **11189	1" x 15'	600 lb	1,800 lb	Blue	Polyester
 12340	1" x 15'	1,000 lb	3,000 lb	Yellow	Polyester
11187	1" x 20'	1,000 lb	3,000 lb	Yellow	Polyester
 12341	2" x 15'	1,300 lb	4,000 lb	Yellow	Polyester
12342	2" x 25'	1,300 lb	4,000 lb	Yellow	Polyester
 12230	1-1/2" x 15'	2,200 lb	6,600 lb	Yellow	Polyester
 11186	1-1/2" x 25'	2,200 lb	6,600 lb	Yellow	Polyester
 11190	2" x 27'	3,300 lb	10,000 lb	Yellow	Polyester
12343	2" x 30'	3,300 lb	10,000 lb	Yellow	Polyester
12346	2" x 20'	3,300 lb	10,000 lb	Yellow	Polyester



* Pack of 2

** Features 2D Rings

Sizes are approximate. Specifications subject to change without notice.

Legend:  12x24  24x24  Plan-O-Gram  Rack/End Cap  Other

Cargo Control





Ratchet Straps with Flat Hooks - Retail Package

PART#	SIZE	W.L.L.	U.L.L.	COLOUR	WEBBING
12353	2" x 20'	3,300 lb	10,000 lb	Yellow	Polyester
12354	2" x 25'	3,300 lb	10,000 lb	Yellow	Polyester
12344	2" x 30'	3,300 lb	10,000 lb	Yellow	Polyester



Ratchet Straps with S-Hooks - Twin Packs

Two medium duty Ratchet Straps in a clamshell package. Vinyl-coated, heat-treated steel hooks.

PART#	SIZE	W.L.L.	U.L.L.	COLOUR	WEBBING
12226	1" x 6'	400 lb	1,200 lb	Black	Polyester



Ratchet Straps with S-Hooks - Four Packs

Four medium duty Ratchet Straps in a clamshell package. Vinyl-coated, heat-treated steel hooks.

PART#	SIZE	W.L.L.	U.L.L.	COLOUR	WEBBING
12320	1" x 15'	400 lb	1,200 lb	Black	Polyester
12321	1" x 15'	400 lb	1,200 lb	Red	Polyester

Ratchet Straps - Bulk

High quality polyester webbing, secure stitching, steel ratchet, heat treated steel hooks, EZ Release ratchet buckle with caps. Individually shrink wrapped.



PART#	SIZE	W.L.L.	U.L.L.	COLOUR	WEBBING & HARDWARE MARKINGS	HOOK TYPE
11183B	1" x 15'	400 lb	1,200 lb	Blue	Yes	"S", vinyl coated
11184B	1" x 20'	1,000 lb	3,000 lb	Yellow	Yes	"S", vinyl coated
12229B	1" x 6'	400 lb	1,200 lb	Yellow	Yes	Double "J"
11187B	1" x 20'	1,000 lb	3,000 lb	Yellow	Yes	Double "J"
*11189B	1" x 15'	600 lb	1,800 lb	Blue	Yes	Double "J"
11190B	2" x 27'	3,300 lb	10,000 lb	Yellow	Yes	Double "J"
12343B	2" x 30'	3,300 lb	10,000 lb	Yellow	Yes	Double "J"
12344B	2" x 30'	3,300 lb	10,000 lb	Yellow	Yes	Flat Hook
12353B	2" x 20'	3,300 lb	10,000 lb	Yellow	Yes	Flat Hook
12354B	2" x 25'	3,300 lb	10,000 lb	Yellow	Yes	Flat Hook

*11189B Features 2 "D" Rings

Sizes are approximate. Specifications subject to change without notice.

Cargo Control

White Recovery Straps

White polyester webbing. Reinforced loop ends.

PART#	SIZE	MAX. VEHICLE WEIGHT	MAX. BREAKING STRENGTH
50915	1" x 15'	3,750 lb (1,703 kg)	7,500 lb (3,504 kg)
50920	2" x 20'	9,000 lb (4,086 kg)	18,000 lb (8,172 kg)
50921	3" x 20'	13,500 lb (6,129 kg)	27,000 lb (12,258 kg)
50922	4" x 20'	17,500 lb (7,945 kg)	35,000 lb (15,890 kg)



Heavy Duty Recovery Straps - 2 Ply

Heavy duty, 2 ply, weather resistant polyester, with reinforced loop ends. Load Capacity imprinted on webbing.

PART#	SIZE	MAX. VEHICLE WEIGHT	MAX. BREAKING STRENGTH
50935	2" x 20'	18,000 lb (8,165 kg)	36,000 lb (16,329 kg)
50936	4" x 20'	27,000 lb (12,247 kg)	54,000 lb (24,493 kg)
50937	4" x 30'	27,000 lb (12,247 kg)	54,000 lb (24,493 kg)
50938	6" x 20'	40,000 lb (18,144 kg)	80,000 lb (36,287 kg)
50939	6" x 30'	40,000 lb (18,144 kg)	80,000 lb (36,287 kg)



Tow Ropes

20 Feet - White nylon with double end looped connection. Individually banded and shrink wrapped.

PART#	DIAMETER	MAX. VEHICLE WEIGHT	MAX. BREAKING STRENGTH
12200	3/4"	7,100 lb	14,200 lb
12201	1"	12,500 lb	25,000 lb
12203	1-1/4"	18,750 lb	37,500 lb



Heavy Duty Tow Ropes

30 Feet - Heavy duty tow ropes. Double ended loop connection. 8 white nylon braided strands. Individually packaged.

PART#	DIAMETER	MAX. VEHICLE WEIGHT	MAX. BREAKING STRENGTH
12208	2-3/8"	56,000 lb	112,000 lb
12209	2-3/4"	75,000 lb	150,000 lb
12210	3-1/8"	97,500 lb	195,000 lb



Truck Winch Straps

Strong, weather-resistant nylon webbing with secure stitching and a variety of steel hooks. To be used with our Lashing and Cargo Winches. Load Capacity imprinted on webbing.

PART#	SIZE	W.L.L.	MAX. LOAD	COLOUR	HOOK TYPE
12242	4" x 30'	5,400 lb	16,200 lb	Yellow	Flat Hook
12243	4" x 30'	5,400 lb	16,200 lb	Yellow	D-Ring
12247	4" x 40'	5,400 lb	16,200 lb	Yellow	D-Ring
12248	4" x 40'	5,400 lb	16,200 lb	Yellow	Flat Hook
12249	4" x 40'	5,400 lb	16,200 lb	Yellow	J-Hook



Sizes are approximate. Specifications subject to change without notice.

Legend: □ 12x24 □ 24x24 □ Plan-O-Gram □ Rack/End Cap ○○○ Other

DYNALINE

Hand-cranked manual winches multiply your strength, allowing you to pull a relatively heavy load against gravity. Larger models have a lower gear ratio to multiply your strength even more. Winches also have a ratchet to hold the load at any point so it doesn't slide back, allowing a normal person to move a load, using a crank about a foot long and simple gearing.

***Load Capacity is based on the direct line pull on the first layer of the line on the drum. Capacity decreases as the line builds up on the drum.**

WARNING: WINCHES ARE NOT FOR THE MOVEMENT OF HUMANS OR FOR HOISTING LOADS OVER AREAS OCCUPIED BY HUMANS.



11345

Hand Winch - Dual Drive

Dual drive feature distributes the load evenly on the drum. To be used with steel cable. Winch drums are drilled for use with winch straps.

- Can be mounted vertically or horizontally.
- Solid carbon steel gears.
- Baked enamel painted finish.
- Supplied with grip handle & cable keeper.

PART#	LOAD CAPACITY*	GEAR RATIO
11345	3,700 lb	12 : 1



11300

Hand Winches - General Purpose

- Solid carbon steel gears.
- Embossed frame for added strength.
- Baked black enamel painted finish.
- Supplied with grip handle and cable keeper.
- Two-way Ratchet.

PART#	DESCRIPTION	LOAD CAPACITY*	GEAR RATIO	REPAIR KIT	HANDLE
11300	1-speed	600 lb	3:01	---	---
11301	1-speed	850 lb	3:01	11331	11321
11303	1-speed	1,200 lb	4:01	11333	11323
11304	1-speed	1,400 lb	4:01	11334	11324
11305	2-speed	2,000 lb	4:1 / 10:1	11335	11325
11306	2-speed & hand brake	2,500 lb	5:1 / 12:1	11336	11326



11308

Hand Winches - Auto Brake

Keeps loads automatically locked in position when handle is released. (Note: Minimum load required to activate brake mechanism).

- Baked black enamel painted finish.
- Supplied with grip handle & cable keeper.

PART#	LOAD CAPACITY*	GEAR RATIO	REPAIR KIT	HANDLE
11308	1,400 lb	4:01	11338	11328
11309	2,000 lb	12:1	---	---
11310	2,500 lb	12:1	---	---

Sizes are approximate. Specifications subject to change without notice.

Hand Winches - Worm Gear

Self-braking mechanism prevents loads from accidentally running free. The load remains fixed in position when handle is released.

- Baked enamel painted finish.
- Supplied with cable keeper.
- Colour box packaging.



PART#	LOAD CAPACITY*	GEAR RATIO	DRUM TYPE
11312	2,000 lb	41:1	Single
11314	2,000 lb	41:1	Double

NEW

Approximate cable and webbing lengths based on popular cable diameters.

PART#	DESCRIPTION	1/8"	3/16"	1/4"	5/16"	3/8"	LENGTH OF THE WEBBING
11300	Hand Winch, 600 lb	—	10M/32'	—	—	—	up to 5M
11301	Hand Winch, 800 lb	20M/65'	10M/32'	15M/49'	—	—	up to 5M
11303	Hand Winch, 1200 lb	25M/82'	20M/65'	20M/65'	—	—	up to 5M
11304	Hand Winch, 1400 lb	25M/82'	20M/65'	20M/65'	—	—	up to 5M
11305	Hand Winch, 2000 lb	—	20M/65'	20M/65'	15M/49'	10M/32'	up to 6M
11306	Hand Winch, 2500 lb	—	45M/150'	30M/98'	20M/65'	15M/49'	up to 6M
11308	Auto Brake Winch, 1400 lb	25M/82'	20M/65'	20M/65'	—	—	up to 6M
11309	Auto Brake Winch, 2000 lb	—	45M/150'	30M/98'	20M/65'	15M/49'	up to 6M
11310	Auto Brake Winch, 2500 lb	—	45M/150'	30M/98'	20M/65'	15M/49'	up to 6M
11312	Worm Gear Winch, 2000 lb	—	—	25M/65'	—	—	up to 6M
11345	Hand Winch Dual Drive, 3200 lb	—	45M/150'	30M/98'	20M/65'	15M/49'	up to 6M

Winch Bar - Type A

PART#	DESCRIPTION
12245	Features knurled non-slip handle & carbon steel tip. 35" length.

Winch Bar - Type C

PART#	DESCRIPTION
12246	Features knurled handle for safe grip. Hardened, ribbed nose to add strength and prevent slippage. 37" length.



Cargo Winch - 3 Bar Type

Fits 4" winch straps.

PART#	DESCRIPTION	TYPE	W.L.L.
12284	Standard	Slide On	5,500 lb
12285	Low Profile	Weld-On	6,000 lb



Cargo Control





Corner Protector

White plastic corner protector. Individually labeled and wrapped in sealed plastic bag. Accommodates up to 4" straps.

PART#	SIZE	COLOUR
12235	4"	White



Anchor Points

Fits most full-size and compact light trucks with or without a bed liner. Chrome plated finish.

PART#	DESCRIPTION	CAPACITY
11166	Fits most full-size and compact light trucks with or without a bed liner.	500lbs



Anchor Rings

Zinc plated finish.

PART#	LENGTH	WIDTH	CAPACITY	PKG. QTY.
12250	1-3/8"	1"	900 lb	2
12253	2-9/16"	2-3/8"	12,000 lb	1



Recessed Anchor Rings

Surface mount. Zinc plated finish.

PART#	WIDTH	CAPACITY
12251	3-1/2"	1,200 lb



Heavy Duty Recessed Anchor Rings

Surface mount. Zinc plated finish.

PART#	WIDTH	CAPACITY
12252	4-7/16"	5,000 lb

Sizes are approximate. Specifications subject to change without notice.

Foldable Handle Ratchet Load Binders

Powder coated finish.

PART#	CHAIN	W.L.L.	U.L.L.
66190	5/16" – 3/8"	7,100 lb	21,300 lb
66191	3/8" – 1/2"	12,000 lb	36,000 lb
66192	1/2" – 5/8"	18,100	54,300 lb



Recoilless Load Binders

Forged steel. Painted finish.

PART#	CHAIN	W.L.L.	U.L.L.
66193	5/16" – 3/8"	5,400	19,000 lb
66194	3/8" – 1/2"	9,200 lb	33,000 lb



Lever Type Load Binders

Forged steel. Painted finish.

PART#	CHAIN	TAKE UP	W.L.L.	U.L.L.
66203	1/4" – 5/16"	3.62	2,600 lb	7,800 lb
66204	5/16" – 3/8"	4.25	5,400 lb	19,000 lb
66202	3/8" – 1/2"	4.25	9,200 lb	33,000 lb



Ratchet Type Load Binders

Forged steel. Painted finish.

PART#	CHAIN	TAKE UP	W.L.L.	U.L.L.
66196	1/4" – 5/16"	5"	2,600 lb	7,800 lb
66197	5/16" – 3/8"	8"	5,400 lb	19,000 lb
66198	3/8" – 1/2"	8"	9,200 lb	33,000 lb
66199	1/2" – 5/8"	9"	13,000 lb	46,000 lb



Load Tighteners

Painted finish.

PART#	CHAIN	TAKE UP	HANDLE	W.L.L.	U.L.L.
66200	3/16" – 1/4"	3-3/8"	Dixie Style	375 lb	1,500 lb
66201	3/16" – 1/4"	3-3/8"	Dominion Style	250 lb	1,000 lb



Load Binder Locks

PART#	DESCRIPTION
66205	Eliminates load binder release. Two width adjustments. Orange comes with tabquick pin
66205-24	Display box + 24 pieces
66535	Replacement Pin, 5/16" x 2"



Cargo Control



Sizes are approximate. Specifications subject to change without notice.



Cable Type Load Binder Locks

Small diameter galvanized cable with aluminum stops and bracket. Lockable with padlock.

PART#	CABLE DIAMETER	LENGTH	PACKAGE QUANTITY
61205	1/8"	10"	400 pieces/carton
62205	3/16"	11"	300 pieces/carton



Fold-Over Handle Load Binders

Forged folding handle and enclosed ratchet gear casement. Easy operation of finger pull selector allows for ratchet extension, take up and free spin rapid-ratcheting. Locking feature for long shank locks. WLL and chain grades stamped into handle and hooks.

PART#	CHAIN SIZE G7-G8-G10	TAKE UP	W.L.L.	U.L.L.	WEIGHT
DFX-38	3/8" - 5/16"	8"	8,800 lb	17,600 lb	12.9 lb
DFX-12	1/2" - 3/8"	8"	12,000 lb	24,000 lb	14.6 lb

Locking Ratchet Racks

The best solution for ratchet binder storage.

- Available in two sizes: 24" and 48"
- Fast and easy to install
- Includes all hardware for installation
- Fits most ratchet binder sizes
- Laser cut frame for perfect fit
- Two piece construction
- Easy to lockup!
- Made of heavy gauge steel or aluminum
- Can be mounted on trailer bulkheads, trucks, headache boxes, and even in shops and garages.



*padlock not included

PART#	MAX RATCHETS HELD	MATERIAL	OVERALL DIMENSIONS	WEIGHT
RRA-L11	11	Aluminum	47.5" x 5.5"	10 lb
RRS-L11	11	Steel	47.5" x 5.5"	19 lb
RRA-L7	7	Aluminum	23.5" x 5.5"	4 lb
RRS-L7	7	Steel	23.5" x 5.5"	10 lb

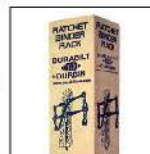

Cargo Control



Sizes are approximate. Specifications subject to change without notice.



Wheel Chocks

Rubber wheel chock for trailers, cars or other small vehicles. Non-slip surface provides superior traction.



PART#	SIZE
11984	7-1/2" x 6" x 3-3/4"
11985	10-5/8" x 7" x 4-1/2"



Wheel Chocks

Made from rubber compound with reinforced nylon fiber. Ideal for trailers and heavy loaded vehicles. Eyebolt for easy handling. To be used for vehicles under 20T.



PART#	SIZE
11986	8" x 6" x 10"



H.D. Trailer & RV Wheel Chock

Made of heavy duty steel construction with corrosion resistant zinc plating. 4 sets per master carton with dynaline shipping markings.

PART#	SIZE
11989	15" x 9.5" x 10"



Wheel Chocks

Yellow plastic wheel chock. Comes packaged in colour box. 2 wheel chocks per box.



PART#	SIZE
11988	8" x 5" x 4-1/4"



Mud Flaps

Sold separately. Each made of heavy rubber.

PART#	SIZE	THICKNESS	MOUNTING HEAD
11981	24" x 24"	1/4"	5/16"
11982	24" x 30"	1/4"	5/16"
11991	24" x 24"	3/8"	7/16"
11992	24" x 30"	7/16"	7/16"
11993	24" x 36"	7/16"	7/16"



Sizes are approximate. Specifications subject to change without notice.



Chain & Rigging

Table of Contents

1.877.453.3964

1.877.453.5050

www.dynaline.com

orders@dynaline.com



Chain & Rigging

A		Merchandise - Chain Hoists	252
Averall Cable	245	Merchandise - Shackles & Clevises	252
Alloy Clevis Chain Hoists	257	Merchandise - Stainless Steel Hardware	251
Alloy Chain Hoists	257	Merchandise - Wire Rope Accessories	252
Alloy Chain Shackle Hoists	256	Weld Units	241
B		P	
Beam Clamps	243	Passing End Chains	254
Beck Swager	246	Proof Coil Chains	254
Ball Type Anchor Shackles	241	Q	
C		Quick Units	242
Cable Covers	247	R	
Cable Pulleys	243	Ratchet Units	242
Cable Slaves	246	S	
Cable Swags	246	Safety Chain Hoists	253
Cable Thimbles	243	Safety Shack Hoist	253
Carbon Clevis Shackle Hoists	256	Sash Chains	253
Chain Hoists	249	Screw Pin Anchor Shackles	240
Chain Lact	252	Screw Pin Chain Shackles	240
Clevis Chain Hoists	257, 258	Safety Chains	253
Clevis Shackle Hoists	256	Self-Locking Chain Hoists	259
Coil Chain	254	Single End Chain	253
Coil Shaws	241	Single Pulley Block With Eye	247
Commercial Grade Anchor Shackles	240	Stainless Steel Shackles	240
Connecting Units	259, 242	Stainless Steel Wire Rope Clips	244
D		Standard Double Pulley Block	247
Double End Chain	253	Standard Single Pulley Block	247
E		Standard Wire Rope Thimbles	243
Eye Chain Hoists	257	Swivel Eye Hoist Hoists	259
Eye Hoist Hoists	258, 259	Swivel Eye Hoist	258
Eye Shackle Hoists	256	T	
F		Top Chain Hardware	247
Forged Chain Swivel	241	Top Chain Flats	247
Forged Steel Wire Rope Clips	244	Turnbuckle Chains	253
Forged-D-Ring	242	Trolleys	248
Furniture Chain	253	Truss End Machine Chain	254
H		W	
Hand Swager	246	Wire Rope	245
Heavy Duty Shack Hoists	243		
Heavy Wire Rope Thimbles	243		
L			
Lever Hoist	249		
Lift Units	242		
M			
Malleable Iron Wire Rope Clips	244		
Master Units	259		
Merchandise - Chain & Steel Cable Lact	252		
Merchandise - Chain Components	251		





Your Trusted Source.

Dynaline Chain Accessories Merchandisers

Dynaline offers merchandisers for almost every product. Merchandisers keep your stock organized, visible and easy to shop.

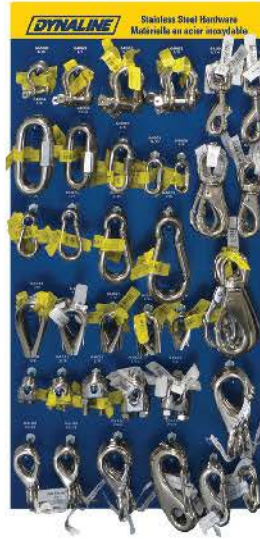

00024 Compatible

00024 Compatible

00024 Compatible

Wire Rope Accessories Merchandisers

PART#	CONTENTS
00566	Wire Rope Accessories Display Board Only, 12" x 24"
00566K	Full Wire Rope Accessories Merchandiser. Includes 00566 display board and 30 pegs (80004) and the products listed.

Full product breakdown on page 34

Stainless Steel Hardware Merchandiser

PART#	CONTENTS
00619	Stainless Steel Hardware Display Board Only, 12" x 24"
00619K	Full Stainless Steel Merchandiser. Includes 00619 display board, 40 pegs (80004) and product listed.

Full product breakdown on page 35

Chain Connectors Merchandiser

PART#	CONTENTS
00614	Chain Connectors Display Board Only, 12" x 24"
00614K	Full Chain Connectors Merchandiser. Includes 00614 display board, 35 pegs (80004) and product listed.

Full product breakdown on page 36

Chain & Rigging

Sizes are approximate. Specifications subject to change without notice. **Not Recommended for overhead lifting.**

Legend: 12x24 24x24 Plan-0-Gram Rack/End Cap Other





Chain & Rigging



Chain Hooks Merchandiser



PART#	CONTENTS
-------	----------

00408 Chain Hooks Display Board Only, 24" x 24"

00408K Full Chain Hooks Merchandiser. Includes 00408 display board, 30 pegs (80004) and products.

i Full product breakdown on page 37



Shackles & Clevises Merchandiser



PART#	CONTENTS
-------	----------

00386 Shackles & Clevises Display Board Only 24" x 24"

00386K Full Shackles & Clevises Merchandiser. Includes 00386 display board, 25 pegs (80004) and products.

i Full product breakdown on page 37

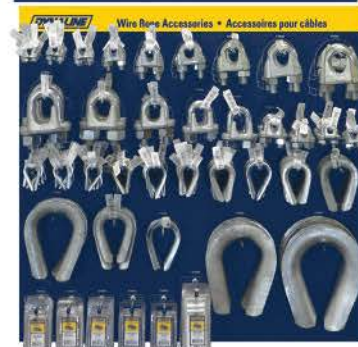

Wire Rope Accessories Merchandiser



PART#	CONTENTS
-------	----------

00567 Wire Rope Display Board Only, 24" x 24"

00567K Full Wire Rope Accessories Merchandiser. Includes 00567 display board and 41 pegs (80004) and products.

i Full product breakdown on page 38

Chain Rack

PART#	CONTENTS
70099	4' Chain Rack Only, 47" wide x 73" high x 13" deep
70099K	Full 4' Chain Rack Merchandiser. Includes 12" x 48" Chain Rack Header and products.
70010	2' Chain Rack Only, 23" wide x 73" high x 13" deep
70010K	Full 2' Chain Rack Merchandiser. Includes 9" x 23" Dynaline Distributor sign (00003) and products.

i Full product breakdown on page 39

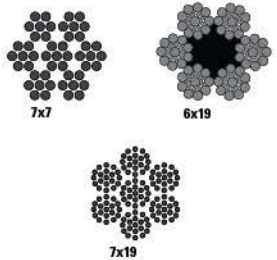
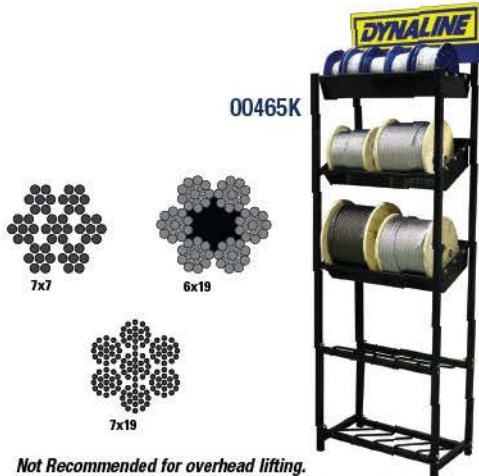

Chain & Steel Cable Rack Merchandiser

PART#	CONTENTS
70010	Steel Cable Rack Only (23" x 13" x 73") Free standing floor rack for Wire Rope Spools
00465K	Full Steel Cable Rack Merchandiser. Includes 70010 Steel Cable Display Rack (Dimensions: 23" x 13" x 73") with 9" x 23" header and products.

i Full product breakdown on page 40

Not Recommended for overhead lifting.
 Sizes are approximate. Specifications subject to change without notice.

Transport Chain (Grade 70)

Alloy steel, Class 7. A high strength, hardened and tempered chain made from alloy steel. For farm and truck load binding applications, towing, construction, and logging. Bright yellow dichromate finish. 4:1 design factor.

- Made to NACM specifications.
- Not to be used in overhead lifting applications.

PART#	CHAIN SIZE	INSIDE LENGTH	INSIDE WIDTH	W.L.L.	WT./100'	PAIL	DRUM
70020	1/4"	1.24"	0.38"	3,150 lb	74 lb	--	800'
70021	5/16"	1.29"	0.44"	4,700 lb	100 lb	--	550'
70022	3/8"	1.38"	0.55"	6,600 lb	145 lb	--	400'
70023	1/2"	1.79"	0.72"	11,300 lb	264 lb	--	200'
70024	1/4"	1.24"	0.38"	3,150 lb	74 lb	130'	--
70025	5/16"	1.29"	0.44"	4,700 lb	100 lb	90'	--
70026	3/8"	1.38"	0.55"	6,600 lb	145 lb	64'	--
70034	1/4"	1.24"	0.38"	3,150 lb	74 lb	65'	--
70035	5/16"	1.29"	0.44"	4,700 lb	100 lb	50'	--
70036	3/8"	1.38"	0.55"	6,600 lb	145 lb	45'	--



Grade 70 Transport Chain Assemblies

Assembled with two plated alloy clevis grab hooks. Comes with aluminum capacity tag. Packaged in durable carry-on bag or plastic pail.

PART#	CHAIN SIZE	LENGTH	W.L.L.	U.L.L.
66051	5/16"	16'	4,700lb	18,800lb
66052	5/16"	20'	4,700lb	18,800lb
66053	3/8"	16'	6,600lb	26,400lb
66054	3/8"	20'	6,600lb	26,400lb
66056	1/2"x20'	20'	11,300lb	45,200lb



Security Chains

Made of hardened steel (20CrMnTi) for increased security. Featuring a polypropylene sleeve to protect surfaces and a metal hoop on one end to maximise usable length. Packaged in a reusable plastic bag.

PART#	CHAIN SIZE	BREAKING STRENGTH	HARDNESS
66084	1/4" x 3'	5,179 Lbs	750±100HV
66085	1/4" x 5'	5,179 Lbs	750±100HV
66086	3/8" x 3'	11,006 Lbs	750±100HV
66087	3/8" x 5'	11,006 Lbs	750±100HV



Sizes are approximate. Specifications subject to change without notice. **Not Recommended for overhead lifting.**



Grade 30 Proof Coil Chain

Low carbon steel, Class 3. A durable and economical utility chain manufactured from carbon steel. For pulling stumps, lashing cargo, logging, towing, mooring, pipeline installations, and truck tailgates.

- Zinc plated finish.
- Made to NACM specifications.
- Not to be used in overhead lifting applications.

PART#	CHAIN SIZE	INSIDE LENGTH	INSIDE WIDTH	W.L.L.	WT./100'	PAIL
70003	3/16"	0.98"	0.3"	800 lb	29 lb	250'
70004	1/4"	1.24"	0.38"	1,300 lb	52 lb	141'
70005	5/16"	1.29"	0.44"	1,900 lb	86 lb	92'
70006	3/8"	1.38"	0.55"	2,650 lb	124 lb	63'
70007	3/16"	0.98"	0.3"	800 lb	29 lb	100'
70008	1/4"	1.24"	0.38"	1,300 lb	52 lb	65'
70013	3/16"	0.98"	0.3"	800 lb	29 lb	150'
70014	1/4"	1.24"	0.38"	1,300 lb	52 lb	100'
70015	5/16"	1.29"	0.44"	1,900 lb	86 lb	75'
70016	3/8"	1.38"	0.55"	2,650 lb	124 lb	45'



Coil Chain (Straight Link)

Low carbon steel, zinc plated. Used in guard chain applications, animal stakes, and farm implements.

PART#	TRADE SIZE	DIAMETER	INSIDE LENGTH	INSIDE WIDTH	W.L.L.	REEL LENGTH	WEIGHT/100'
70040	#4	0.12"	1.11"	0.21"	205 lb	100'	10 lb

Passing Link Chain

Low carbon steel, zinc plated. General utility chain that resists kinks or knots.

PART#	TRADE SIZE	DIAMETER	INSIDE LENGTH	INSIDE WIDTH	W.L.L.	REEL LENGTH	WEIGHT/100'
70045	#2/0	0.19"	0.88"	0.47"	450 lb	120'	32 lb

Twist Link Machine Chain

Zinc plated. General utility chain that lays flat against a surface. Ideal for tie-down applications.

PART#	TRADE SIZE	DIAMETER	INSIDE LENGTH	INSIDE WIDTH	W.L.L.	REEL LENGTH	WEIGHT/100'
70050	#2/0	0.19"	0.73"	0.28"	520 lb	75'	34 lb
70051	#4	0.12"	0.52"	0.17"	200 lb	100'	13 lb

Sizes are approximate. Specifications subject to change without notice. **Not Recommended for overhead lifting.**



Double Loop Chain (Tenso Or Lion)

Zinc plated. For animal restraints, swings, door crash stops.

PART#	TRADE SIZE	DIAMETER	INSIDE LENGTH	INSIDE WIDTH	W.L.L.	REEL LENGTH	WEIGHT/100'
70060	#2/0	0.135"	1.82"	0.34"	255 lb	150'	17 lb
70063	#3	0.08"	1.10"	0.187"	90 lb	200'	6 lb



Double Loop Chain

Vinyl covered, blue or green.

PART#	TRADE SIZE	DIAMETER	INSIDE LENGTH	INSIDE WIDTH	W.L.L.	BOX LENGTH	WEIGHT/100'
70062	#2	0.091"	1.33"	0.167"	115 lb	125'	11 lb



Sash Chain

Zinc plated. Specifically designed to operate smoothly over pulleys. Ideal for hanging sash.

PART#	TRADE SIZE	DIAMETER	INSIDE LENGTH	INSIDE WIDTH	W.L.L.	REEL LENGTH	WEIGHT/100'
70075	#35	0.035"	0.57"	--	106 lb	100'	5.7 lb



Furnace Chain

Zinc plated. Light Duty, retainer chain.

PART#	TRADE SIZE	DIAMETER	INSIDE LENGTH	INSIDE WIDTH	W.L.L.	REEL LENGTH	WEIGHT/100'
70080	#1/0	0.022"	0.50"	0.199"	35 lb	250'	2.3 lb



Single Jack Chain

Zinc plated. For animal restraints, swings, door crash stops.

PART#	TRADE SIZE	DIAMETER	INSIDE LENGTH	W.L.L.	REEL LENGTH	WEIGHT/100'
70085	#10T	0.135"	0.093"	43 lb	150'	14 lb
70086	#12	0.105"	0.75"	29 lb	100'	8.5 lb
70087	#14	0.080"	0.63"	16 lb	200'	4.8 lb



68013

Sizes are approximate. Specifications subject to change without notice. **Not Recommended for overhead lifting.**



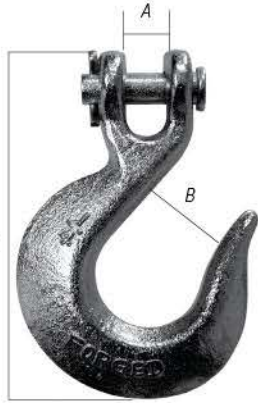

Clevis Slip Hooks

Forged carbon steel. Clear zinc plated finish.
For use with Grade 30 & Grade 40 chains.



PART#	CHAIN DIAMETER	PIN	A	B	C	W.L.L.	U.L.L.
66115	1/4"	3/8"	7/16"	15/16"	4"	1,950 lb	7,800 lb
66116	5/16"	7/16"	1/2"	1-1/16"	4-1/2"	2,875 lb	11,500 lb
66117	3/8"	1/2"	9/16"	1-5/16"	5-3/8"	4,000 lb	16,000 lb
66118	7/16"	9/16"	5/8"	1-9/16"	6"	5,000 lb	20,000 lb
66119	1/2"	5/8"	3/4"	1-11/16"	6-3/4"	6,500 lb	26,000 lb



Eye Slip Hooks

Forged carbon steel. Clear zinc plated finish.
For use with Grade 30 & Grade 40 chains.

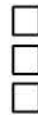

PART#	CHAIN DIAMETER	A	B	C	W.L.L.	U.L.L.
66129	1/4"	1/2"	15/16"	3-5/8"	1,950 lb	7,800 lb
66130	5/16"	5/8"	1-1/16"	4-3/16"	2,875 lb	11,500 lb
66131	3/8"	11/16"	1-5/16"	4-7/8"	4,000 lb	16,000 lb

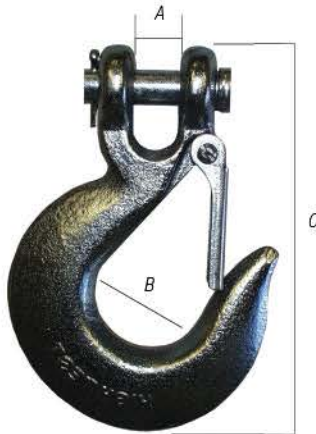

Carbon Clevis Slip Hooks With Latch

Forged carbon steel. Clear zinc plated finish.
For use with Grade 30 & Grade 40 chains.

PART#	CHAIN DIAMETER	PIN	A	B	C	W.L.L.	U.L.L.
66070	1/4"	3/8"	7/16"	15/16"	4"	1,950 lb	7,800 lb
66071	5/16"	3/8"	1/2"	1-1/16"	4-1/2"	2,875 lb	11,000 lb
66072	3/8"	7/16"	5/8"	1-5/8"	5-1/4"	4,000 lb	16,000 lb

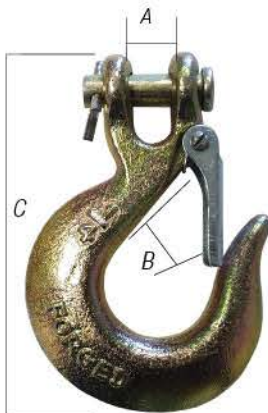

Alloy Clevis Slip Hooks With Latch

Forged alloy steel. For use with Grade 70 chain.
Yellow zinc dichromate plated finish.



PART#	CHAIN DIAMETER	PIN	A	B	C	W.L.L.	U.L.L.
66073	1/4"	3/8"	7/16"	15/16"	4"	2,750 lb	11,000 lb
66074	5/16"	7/16"	1/2"	1-1/16"	4-1/2"	4,300 lb	17,200 lb
66075	3/8"	7/16"	5/8"	1-5/8"	5-3/16"	5,250 lb	21,000 lb
66076	1/2"	5/8"	3/4"	1-3/4"	6-6/8"	9,000 lb	36,000 lb

Sizes are approximate. Specifications subject to change without notice. **Not Recommended for overhead lifting.**



Clevis Grab Hooks

Forged carbon steel. Clear zinc plated finish.
For use with Grade 30 & Grade 40 chain.

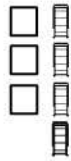

PART#	CHAIN DIAMETER	PIN	A	B	C	W.L.L.	U.L.L.
66110	1/4"	3/8"	0.36"	13/32"	3-3/8"	2,600 lb	10,400 lb
66111	5/16"	7/16"	0.40"	7/16"	3-15/16"	3,900 lb	15,600 lb
66112	3/8"	1/2"	0.48"	1/2"	4-1/2"	5,400 lb	21,600 lb
66113	7/16"	9/16"	0.66"	9/16"	5"	7,200 lb	28,800 lb
66114	1/2"	5/8"	0.75"	5/8"	5-3/4"	9,200 lb	36,800 lb

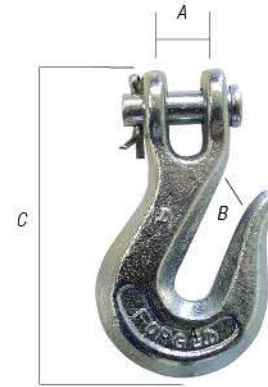

Alloy Clevis Grab Hooks

Forged alloy steel. For use with Grade 70 chain.
Yellow zinc dichromate plated finish.

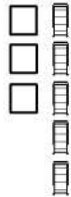

PART#	CHAIN DIAMETER	PIN	A	B	C	W.L.L.	U.L.L.
66120	1/4"	3/8"	5/16"	13/32"	3-3/8"	3,600 lb	14,400 lb
66121	5/16"	7/16"	3/8"	7/16"	3-15/16"	5,400 lb	21,600 lb
66122	3/8"	15/32"	7/16"	1/2"	4-1/2"	7,500 lb	30,000 lb
66126	7/16"	9/16"	21/32"	9/16"	5"	10,000 lb	40,000 lb
66127	1/2"	5/8"	3/4"	21/32"	5-7/8"	12,750 lb	51,000 lb

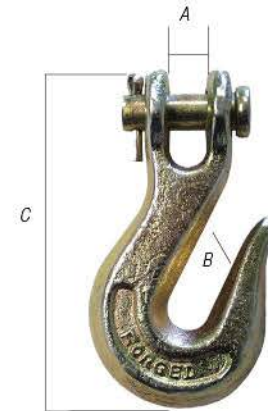

Eye Grab Hooks

Forged carbon steel. Clear zinc plated finish.
For use with Grade 30 chains.



PART#	CHAIN DIAMETER	A	B	C	W.L.L.	U.L.L.
66123	1/4"	1/2"	11/32"	3-1/16"	2,600 lb	10,400 lb
66124	5/16"	9/16"	7/16"	3-9/16"	3,900 lb	15,600 lb
66125	3/8"	13/16"	1/2"	4-1/4"	5,400 lb	21,600 lb

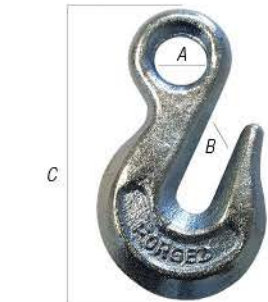

Alloy Clevis Hooks With Latch

Forged alloy steel. For use with Grade 70 chain.
Yellow zinc dichromate plated finish.



PART#	CHAIN DIAMETER	A	B	C	W.L.L.	U.L.L.
66080	1/4"	3/8"	3/8"	1-15/16"	3,600 lb	14,400 lb
66081	5/16"	3/8"	7/16"	2-1/4"	5,400 lb	21,000 lb
66082	3/8"	1/2"	1/2"	2-5/8"	7,500 lb	30,000 lb
66083	1/2"	13/16"	11/16"	3-3/16"	12,750 lb	51,000 lb

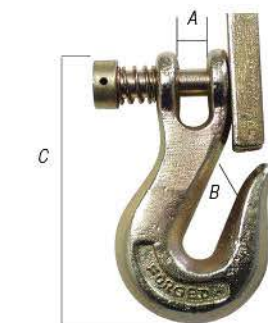

Chain & Rigging



Sizes are approximate. Specifications subject to change without notice. **Not Recommended for overhead lifting.**

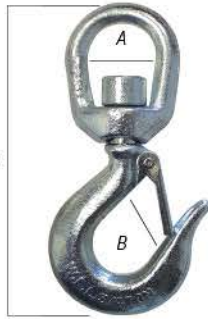

Swivel Eye Hook

Forged carbon steel. Clear zinc plated finish. Not recommended for overhead lifting.

PART#	A	B	C	W.L.L.	U.L.L.
66134	1-1/4"	7/8"	5-9/16"	1,500 lb	7,500 lb



Safety Slip Hooks

Forged carbon steel. Clear zinc plated finish. Not recommended for overhead lifting.

PART#	CHAIN DIAMETER	A	B	C	W.L.L.	U.L.L.
66133	1/4"	1/2"	3/4"	3-5/8"	1,950 lb	7,800 lb
66135	5/16"	5/8"	13/16"	4-3/16"	2,875 lb	11,500 lb

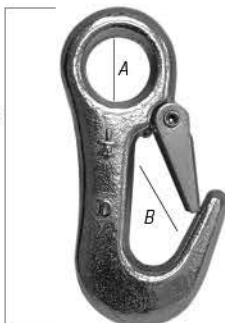

Safety Winch Hook

Forged carbon steel. Clear zinc plated finish. Not recommended for overhead lifting.

PART#	CHAIN DIAMETER	A	B	C	W.L.L.	U.L.L.
<input type="checkbox"/> <input type="checkbox"/> <input type="checkbox"/> 66136	1/4"	3/4"	3/4"	3-5/8"	1,500 lb	6,000 lb

Eye Hoist Hooks - Carbon Steel (Orange)

Complete with latches. Enamel painted finish. 5:1 safety factor.

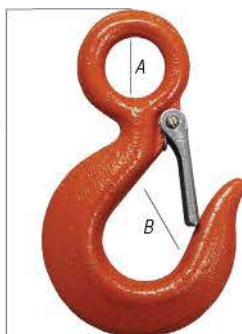

PART#	A	B	C	W.L.L. (TONS)	U.L.L. (TONS)	LATCH KIT
<input type="checkbox"/> <input type="checkbox"/> <input type="checkbox"/> 66145	3/4"	13/16"	4-5/16"	3/4	3-3/4	66151
<input type="checkbox"/> <input type="checkbox"/> <input type="checkbox"/> 66146	7/8"	1-1/32"	4-7/8"	1	5	66152
<input type="checkbox"/> <input type="checkbox"/> <input type="checkbox"/> 66147	1-1/8"	1-1/16"	5-5/8"	1-1/2	7-1/2	66153
<input type="checkbox"/> <input type="checkbox"/> <input type="checkbox"/> 66148	1-1/4"	1-7/32"	6-1/2"	2	10	66154
<input type="checkbox"/> <input type="checkbox"/> <input type="checkbox"/> 66149	1-1/2"	1-1/2"	8"	3	15	66155
<input type="checkbox"/> <input type="checkbox"/> <input type="checkbox"/> 66150	2"	1-7/8"	10-1/4"	5	25	66156

Sizes are approximate. Specifications subject to change without notice. **Not Recommended for overhead lifting.**



Eye Hoist Hooks - Alloy Steel (Yellow)

Complete with latches. Enamel painted finish. 5:1 safety factor.

PART#	A	B	C	D	W.L.L. (TONS)	LATCH KIT
67145	5/8"	15/16"	3-7/8"	2-3/4"	3/4	66151
67146	3/4"	1-1/32"	4-3/8"	3-3/16"	1	66152
67147	15/16"	1-1/8"	4-7/8"	3-11/16"	1-1/2	66153
67148	1-1/8"	1-7/32"	5-1/2"	4"	2	66154
67149	1-1/4"	1-3/8"	6-1/2"	4-11/16"	3	66155

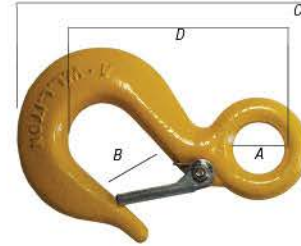

Master Links (Grade 80)

PART#	CHAIN DIAMETER	A	B	C	W.L.L.
67005	1/2"	2-1/2"	5"	6"	3.4T
67006	5/8"	3"	6"	7-1/4"	4T
67007	3/4"	2-3/4"	7"	9"	5.6T
67008	1"	3-1/2"	7"	9"	11.8T

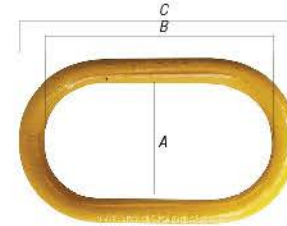

Connecting Links (Grade 80)



PART#	CHAIN DIAMETER	A	B	C	D	W.L.L.
67020	1/4"	3/8"	1-7/8"	1-3/4"	2-1/2"	1.5 T
67021	5/16"	25/64"	2-1/8"	2"	3"	2 T
67022	3/8"	17/32"	2-1/2"	2-1/2"	3-1/2"	3.2 T
67023	1/2"	5/8"	3-7/16"	3-7/32"	4-1/2"	5.4 T

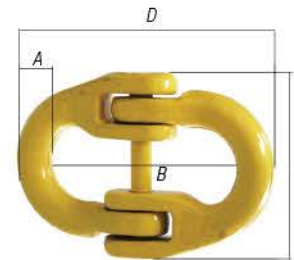

Clevis Grab Hooks (Grade 80)

PART#	CHAIN DIAMETER	A	B	C	W.L.L.
67025	1/4"	3/8"	3/8"	3-11/16"	1.2T
67026	3/8"	1/2"	1/2"	5"	3.2T
67027	1/2"	5/8"	5/8"	5-13/16"	5.4T

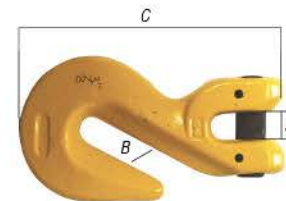

Clevis Sling Hooks (Grade 80)

PART#	CHAIN DIAMETER	A	B	C	W.L.L.	LATCH KIT
67030	1/4"	3/8"	1-3/8"	4-3/8"	1.2T	67030-1
67031	3/8"	9/16"	1-11/16"	6-1/8"	3.15T	67031-1
67032	1/2"	5/8"	2"	7-5/8"	5.3T	67032-1

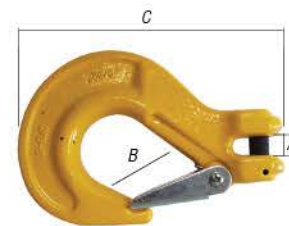

NEVER exceed Working Load Limits! Do not use less than Grade 80 fittings with any application! Do not use chain or fittings showing signs of wear or deformities!

Self-Locking Clevis Hooks

PART#	CHAIN DIAMETER	A	B	W.L.L.	LATCH KIT
67040	9/32"	3-1/2"	6-1/4"	4,500 lb	67040-1
67041	3/8"	4-3/8"	7-1/2"	6,400 lb	67041-1
67042	1/2"	5-7/16"	9-1/2"	10,800 lb	67042-1

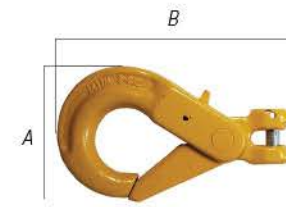

Swivel Eye Hoist Hooks

Design factor 4:1.

PART#	CHAIN DIAMETER	A	B	W.L.L.	LATCH KIT
67050	1/4"	2-3/4"	7"	3,500 lb	67040-1
67051	3/8"	4-3/8"	10-3/4"	7,100 lb	67041-1
67052	1/2"	5-3/8"	12-3/4"	12,000 lb	67042-1

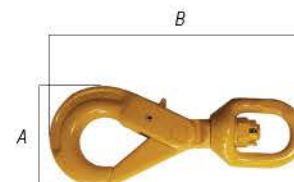

Sizes are approximate. Specifications subject to change without notice. **Not Recommended for overhead lifting.**

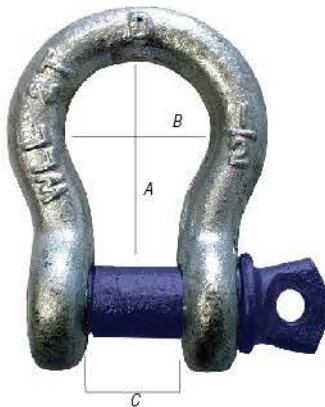

Screw Pin Anchor Shackles

Heat treated alloy forged steel. Oversized alloy pin. Hot dipped galvanized finish. Meets Fed. Spec. RR-C-271D, Type 4A, Class 2, Design factor 6:1. Marked for Traceability: "D" marking for Dynaline.

PART#	BODY DIAMETER	PIN DIAMETER	A	B	C	W.L.L. (TONS)
66000	1/4"	5/16"	1-1/8"	3/4"	1/2"	1/2
66001	5/16"	3/8"	1-1/4"	7/8"	1/2"	3/4
66002	3/8"	7/16"	1-7/16"	1"	5/8"	1
66003	7/16"	1/2"	1-11/16"	1-1/8"	3/4"	1-1/2
66004	1/2"	5/8"	1-7/8"	1-5/16"	3/4"	2
66005	5/8"	3/4"	2-3/8"	1-5/8"	1-1/16"	3-1/4
66006	3/4"	7/8"	2-3/4"	2"	1-1/4"	4-3/4
66007	7/8"	1"	3-5/16"	2-1/4"	1-7/16"	6-1/2
66008	1"	1-1/8"	3-3/4"	2-11/16"	1-11/16"	8-1/2
66059	1-1/8"	1-1/4"	4-1/4"	2-5/8"	1-3/4"	9-1/2
66060	1-1/4"	1-3/8"	4-11/16"	3"	2"	12
66061	1-3/8"	1-1/2"	5-1/4"	3-5/8"	2-1/4"	13-1/2
66062	1-1/2"	1-5/8"	5-3/4"	3-7/8"	2-3/8"	17

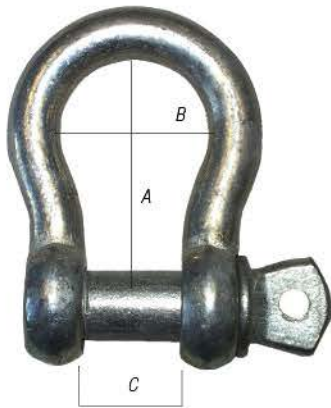

Commercial Grade Anchor Shackles

Oversized pin. C1010 Carbon Steel, galvanized. For general applications. Design factor 2:1. Not to be used for lifting.

PART#	BODY DIAMETER	PIN DIAMETER	A	B	C	W.L.L.
66010	1/4"	5/16"	1-1/8"	3/4"	1/2"	600 lb
66011	5/16"	3/8"	1-7/32"	13/16"	17/32"	1/2 Ton
66012	3/8"	7/16"	1-7/16"	15/16"	1-7/16"	3/4 Tons
66013	1/2"	5/8"	1-7/8"	1-5/16"	13/16"	1-1/2 Tons
66014	5/8"	3/4"	2-3/8"	1-11/16"	1-1/16"	2-1/4 Tons
66017	7/16"	1/2"	1-11/16"	1-5/32"	11/16"	1-1/4 Tons



Stainless Steel Shackles

A151 316 Stainless steel.

PART#	BODY DIAMETER	PIN DIAMETER	A	B	C	W.L.L.
64060	3/16"	1/4"	7/8"	11/16"	3/8"	300 lb
64061	1/4"	5/16"	1-1/8"	3/4"	1/2"	450 lb
64062	5/16"	13/32"	1-3/16"	13/16"	19/32"	650 lb
64063	3/8"	1/2"	1-3/8"	1"	11/16"	1,000 lb

Screw Pin Chain Shackles

High-tensile forged steel. Oversized pin. Hot dipped galvanized finish. Meets Fed. Spec. RR-C-271D, Type 4B, Class 2. Design factor 6:1.



PART#	BODY DIAMETER	PIN DIAMETER	A	B	W.L.L. (TONS)
66020	1/4"	5/16"	7/8"	7/16"	1/2
66021	5/16"	3/8"	1"	9/16"	3/4
66022	3/8"	7/16"	1-1/4"	5/8"	1
66023	7/16"	1/2"	1-7/16"	11/16"	1-1/2
66024	1/2"	5/8"	1-5/8"	3/4"	2

Sizes are approximate. Specifications subject to change without notice. **Not Recommended for overhead lifting.**



Bolt Type Anchor Shackles

High-tensile forged steel. Oversized pin. Hot dipped galvanized finish. Meets Fed. Spec. RR-C-271D, Type 4A, Class 3. Design factor 6:1.

PART#	BODY DIAMETER	PIN DIAMETER	A	B	C	W.L.L. (TONS)
66900	1/4"	5/16"	1-1/8"	3/4"	1/2"	1/2
66901	5/16"	3/8"	1-1/4"	7/8"	1/2"	3/4
66902	3/8"	7/16"	1-7/16"	1"	5/8"	1
66903	7/16"	1/2"	1-11/16"	1-1/8"	3/4"	1-1/2
66904	1/2"	5/8"	1-7/8"	1-5/16"	3/4"	2
66905	5/8"	3/4"	2-3/8"	1-5/8"	1-1/16"	3-1/4
66906	3/4"	7/8"	2-3/4"	2"	1-1/4"	4-3/4
66907	7/8"	1"	3-5/16"	2-1/4"	1-7/16"	6-1/2
66908	1"	1-1/8"	3-3/4"	2-11/16"	1-11/16"	8-1/2
66959	1-1/8"	1-1/4"	4-1/4"	2-5/8"	1-3/4"	9-1/2
66960	1-1/4"	1-3/8"	4-11/16"	3"	2"	12

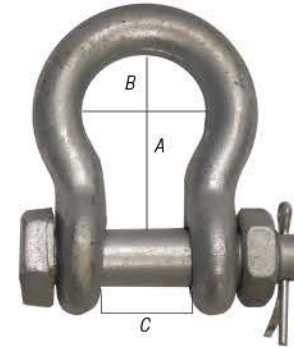

Mid Links

Forged carbon steel body. Alloy steel pins. Yellow zinc dichromate plated finish. For use with Grade 30, 40 & 70 chain.

PART#	CHAIN	PIN DIAMETER	A	B	C	D	W.L.L.	U.L.L.
66138	1/4"-5/16"	3/8"	7/16"	2-1/2"	1-5/8"	1-3/16"	4,700 lb	18,800 lb
66139	3/8"	7/16"	1/2"	2-13/16"	1-13/16"	1-3/8"	6,600 lb	26,400 lb
66140	7/16"-1/2"	9/16"	5/8"	3-5/8"	2-3/16"	1-3/4"	11,250 lb	45,000 lb

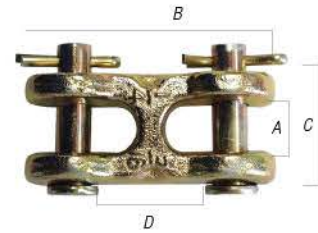

Notice: If pins are difficult to remove after 1/4 turn, it has likely been overloaded, and must be discarded and replaced.

Cold Shuts

Formed steel. Clear zinc plated finish.

PART#	WIRE	W.L.L.	PACKAGE QUANTITY
66440	3/16"	550 lb	10
66441	1/4"	750 lb	10
66442	5/16"	1,250 lb	5
66443	3/8"	1,900 lb	5
66444	7/16"	2,650 lb	5
66445	1/2"	3,500 lb	5



Forged Chain Swivel

Hot dipped, galvanized. Meets Fed. Spec. RR-C-271D-Type 7, Class 2. Not designed to swivel under load!

PART#	A	B	C	D	W.L.L.	U.L.L.
66165	1/4"	1-1/16"	3"	3-7/16"	850 lb	4,250 lb
66166	5/16"	1-1/4"	3-9/16"	4-1/8"	1,250 lb	6,250 lb
66167	3/8"	1-1/2"	4-5/16"	5-7/16"	2,250 lb	11,250 lb
66168	1/2"	2"	5-7/16"	6-7/16"	3,600 lb	18,000 lb

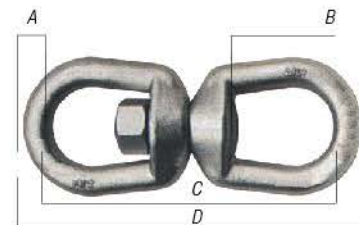

Sizes are approximate. Specifications subject to change without notice. **Not Recommended for overhead lifting.**

Chain & Rigging

Repair & Quick Links • Link Locks • D-Ring

1.877.453.3964

1.877.453.5050

www.dynaline.com

orders@dynaline.com



Chain & Rigging

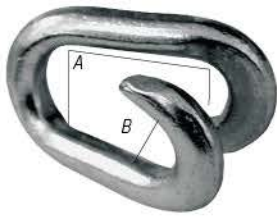

Repair Links

Mild steel. Clear zinc plated finish.

PART#	CHAIN	A	B	W.L.L.	U.L.L.
66400	1/8"	3/4"	1/4"	150 lb	600 lb
66401	3/16"	1"	1/2"	200 lb	800 lb
66402	1/4"	1-1/4"	1/2"	400 lb	1,600 lb
66403	5/16"	1-1/2"	3/4"	700 lb	2,800 lb
66404	3/8"	1-5/8"	3/4"	1,500 lb	6,000 lb

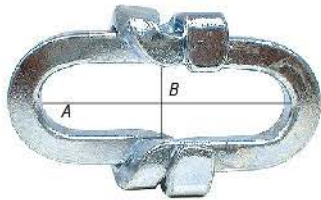

Link Locks

PART#	CHAIN	A	B	W.L.L.	U.L.L.
66413	1/4"	2-1/4"	5/8"	1,000 lb	3,700 lb
66414	5/16"	2-3/4"	3/4"	1,500 lb	6,000 lb
66415	3/8"	3-1/8"	3/4"	3,000 lb	12,000 lb

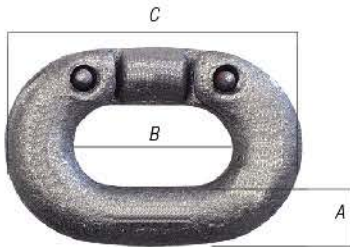

"Missing Link" Connecting Links

Forged steel, Grade 30.

PART#	CHAIN	A	B	C	W.L.L.
66416	1/4"	9/32"	7/8"	1-1/2"	1,125 lb
66417	5/16"	11/32"	15/16"	1-11/16"	1,700 lb
66418	3/8"	13/32"	1-1/8"	2-1/16"	2,325 lb

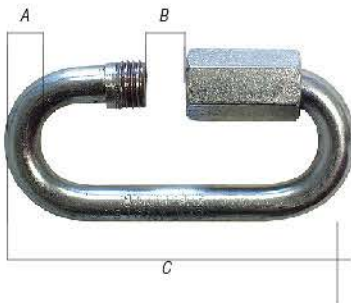

Quick Links - Zinc Plated

Zinc plated. Mild steel.

PART#	A	B	C	W.L.L.	U.L.L.
66430	1/8"	3/16"	1-7/16"	220 lb	550 lb
66431	3/16"	1/4"	2"	660 lb	1,650 lb
66432	1/4"	9/32"	2-1/4"	880 lb	2,200 lb
66433	5/16"	11/32"	2-15/16"	1,760 lb	4,400 lb
66434	3/8"	7/16"	3-9/16"	2,200 lb	5,500 lb
66435	7/16"	1/2"	3-11/16"	2,640 lb	6,600 lb
66436	1/2"	9/16"	4-1/8"	3,300 lb	8,250 lb

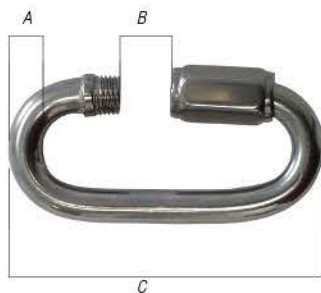

Quick Links - Stainless Steel

A151 316 Stainless Steel.

PART#	A	B	C	W.L.L.
64000	1/8"	3/16"	1-7/16"	220 lb
64001	5/32"	7/32"	1-5/8"	400 lb
64002	1/4"	11/32"	2-9/32"	880 lb
64003	5/16"	3/8"	2-7/8"	1,600 lb
64004	3/8"	1/2"	3-1/2"	2,200 lb



Forged-D-Ring With Weld-On Bracket

Forged, hot dipped, galvanized. Comes with weld-on bracket.

PART#	WIRE DIAMETER	A	B	W.L.L.
66185	1/2"	2-1/4"	2-1/2"	3,000 lb
66186	5/8"	3"	3"	4,500 lb
66187	3/4"	3"	3"	6,625 lb
66188	1"	3"	4"	11,750 lb

Sizes are approximate. Specifications subject to change without notice. **Not Recommended for overhead lifting.**

Aircraft Cable 7 X 7 Construction

Galvanized 70# steel. Supplied on spools.

PART#	CABLE DIAMETER	BREAK STRENGTH	SPOOL LENGTH
77000	1/16"	480 lb	500'
77001	3/32"	920 lb	500'
77002	1/8"	1,700 lb	250'
77010	1/16"	480 lb	1,000'
77011	3/32"	920 lb	1,000'
77012	1/8"	1,700 lb	1,000'

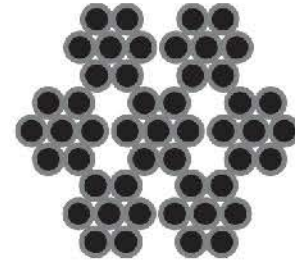

Aircraft Cable 7 X 19 Construction

Galvanized 70# steel. Supplied on spools.

PART#	CABLE DIAMETER	BREAK STRENGTH	SPOOL LENGTH
77003	5/32"	2,800 lb	250'
77004	3/16"	4,200 lb	250'
77005	1/4"	7,000 lb	250'
77006	5/16"	9,800 lb	250'
77007	3/8"	14,400 lb	250'
77013	5/32"	2,800 lb	1,000'
77014	3/16"	4,200 lb	1,000'
77015	1/4"	7,000 lb	1,000'
77016	5/16"	9,800 lb	1,000'
77017	3/8"	14,400 lb	1,000'

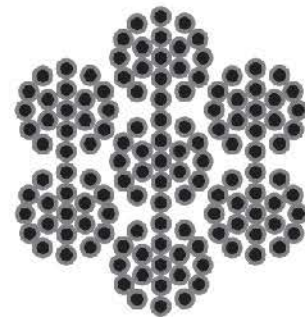

Wire Rope

Supplied in coils. Oily finish. Fibre core.

PART#	ROPE DIAMETER	BREAK STRENGTH	SPOOL LENGTH
77020	1/2"	22,000 lb	100'

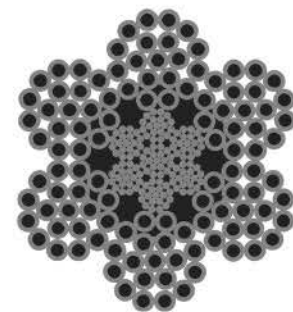

Sizes are approximate. Specifications subject to change without notice. **Not Recommended for overhead lifting.**





Malleable Iron Wire Rope Clips

Galvanized iron saddles. Meets Federal Specification FF-C-450, Type 1, Class 2*, (except 1/8"). Complete with U-bolts and nuts.

PART#	CABLE	PACKAGE QUANTITY
77030	1/8"	10
77031	3/16"	10
77032	1/4"	10
77033	5/16"	10
77034	3/8"	5
77035	1/2"	5
77036	5/8"	1
77037	3/4"	1
77038	7/8"	1
77039	1"	1

Forged Steel Wire Rope Clips

Forged steel body. Zinc plated finish. Meets Federal Specification FF-C-450, Type 1, Class 1**. Complete with U-bolts and nuts.



PART#	CABLE	PACKAGE QUANTITY
77040	1/8"	5
77041	3/16"	5
77042	1/4"	5
77043	5/16"	5
77044	3/8"	5
77045	1/2"	5
77046	5/8"	1
77047	3/4"	1
77048	7/8"	1
77049	1"	1

Stainless Steel Wire Rope Clips

Metric thread. Stainless Steel Grade 304***.



PART#	CABLE	PACKAGE QUANTITY
64020	1/8"	5
64021	3/16"	5
64022	1/4"	5
64023	5/16"	5
64024	3/8"	5

* Type 1 - Single grip, single saddle, with U-bolts and nuts (MS16842).
Class 2 - Assembled with separate hex headed bolts and nuts (MS51868).

** Type 1 - Single grip, single saddle, with U-bolts and nuts (MS16842).
Class 1 - Steel saddle.

*** Grade 304 - is the standard "18/8" stainless; it is the most versatile and most widely used stainless steel, available in a wider range of products, forms and finishes than any other. It has excellent forming and welding characteristics.

Sizes are approximate. Specifications subject to change without notice. **Not Recommended for overhead lifting.**



Cable Thimbles

Stainless Steel. Grade 304.

PART#	CABLE	PACKAGE QUANTITY
64040	1/8"	5
64041	3/16"	5
64042	1/4"	5
64043	5/16"	5
64044	3/8"	5



Standard Wire Rope Thimbles

Zinc plated steel. Meets Federal Specification FF-T-276B, Type 2.

PART#	CABLE	PACKAGE QUANTITY	PART#	CABLE	PACKAGE QUANTITY
77050	1/8"	10	77054	3/8"	10
77051	3/16"	10	77055	1/2"	5
77052	1/4"	10	77056	5/8"	1
77053	5/16"	10			



Heavy Wire Rope Thimbles

Hot dipped galvanized steel. Meets Federal Specification FF-T-276B, Type 3.

PART#	CABLE	PACKAGE QUANTITY	PART#	CABLE	PACKAGE QUANTITY
77060	1/4"	10	77065	3/4"	1
77061	5/16"	10	77066	7/8"	1
77062	3/8"	10	77067	1"	1
77063	1/2"	5	77068	1-1/8"	1
77064	5/8"	1			



Warning: Thimbles are not designed to support loads.

WIRE ROPE CLIP INSTALLATION

- Apply 1st clip one base width from dead end of the rope; U-bolt over dead end; live end rests in clip saddle. Tighten nuts evenly to recommended torque.
- Apply 2nd clip as close to loop as possible; U-bolt over dead end; turn nuts firmly but do not tighten!
- Space all other clips evenly between the first two.
- Apply tension and tighten all nuts to recommended torque.
Re-check nut torque after rope has been in operation.

NOTE: Properly swagged cable sleeves are capable of maintaining over 90% of the breaking strength of the cable.

The maximum holding strength of cable stops are approximately 1/3 of the strength of the cable.

To determine the exact holding strength, a pull test must be performed prior to use.

Sizes are approximate. Specifications subject to change without notice. **Not Recommended for overhead lifting.**



Chain & Rigging

Cable Stops • Cable Sleeves • Swagers

1.877.453.3964

1.877.453.5050

www.dynaline.com

orders@dynaline.com

Cable Stops

Aluminum.



PART#	CABLE	LENGTH	PACKAGE QUANTITY	DYNAPAK	PACKAGE QUANTITY
77070	1/16"	3/16"	10	97070	10 x 77070
77071	3/32"	5/16"	10	97071	10 x 77071
77072	1/8"	5/16"	10	97072	10 x 77072
77073	5/32"	5/16"	10	97073	10 x 77073
77074	3/16"	3/8"	10	97074	10 x 77074
77075	1/4"	11/16"	5	97075	5 x 77075

Cable Sleeves (Ferrule)

Aluminum.



PART#	CABLE	LENGTH	PACKAGE QUANTITY	DYNAPAK	PACKAGE QUANTITY
77080	1/16"	3/8"	10	97080	10 x 77080
77081	3/32"	1/2"	10	97081	10 x 77081
77082	1/8"	5/8"	10	97082	10 x 77082
77083	5/32"	9/16"	10	97083	10 x 77083
77084	3/16"	1"	10	97084	6 x 77084
77085	1/4"	1-1/8"	10	97085	5 x 77085
77086	5/16"	1-1/4"	10		
77087	3/8"	1-1/2"	10		

NOTE:

Properly swagged cable sleeves are capable of maintaining over 90% of the breaking strength of the cable.

The maximum holding strength of cable stops are approximately 1/3 of the strength of the cable.

To determine the exact holding strength, a pull test must be performed prior to use.



Bench Swager

For in-shop, one location jobs. Multi-compression jaws swager for 1/16", 3/32", 1/8", 5/32" & 3/16" oval/stop sleeves.

PART#	LENGTH	HEIGHT (OPEN)	WEIGHT
77101	22-1/2"	24"	3 kg



Hand Swager

For installing aluminum or copper sleeves & stops. Heat-treated alloy jaws.

PART#	CRIMPING CAPACITY	LENGTH
77100	1/16" to 3/16" Diameter	24"



Sizes are approximate. Specifications subject to change without notice. **Not Recommended for overhead lifting.**



Chain & Rigging



Cable Cutters

Aluminum drop-forged handles. Heat-treated blades (HRC 56-63). SK-5 cutter material.

PART#	REFERENCE#	CUTTING CAPACITY	OVERALL LENGTH
77107	C-7	Up to 5/32" Diameter Cable	7-1/2"
77116	C-16	Up to 5/8" Diameter Cable	23"



Tire Chain Pliers

Opens & closes chain hardware easily. Alloy steel jaws. Steel handles with rubber hand grips.

PART#	OVERALL LENGTH	JAW OPENING
68100	32"	2"



Tire Chain Hardware

Made from C-1020 carbon steel.

PART#	DESCRIPTION	OVERALL LENGTH
68012	C-Hook	4"
68013	Boomer	6-1/2"
68014	C-Link	2-1/2"
68015	C-Hook	3-1/2"



Standard Single Pulley Block

PART#	SIZE	W.L.L.	ROPE DIAMETER	OVERALL LENGTH	DESCRIPTION
80335	3"	1/2 Ton	8 mm (5/16")	11"	Loop, Safety Latch, Access Latch & Grease Fitting



Standard Double Pulley Block

PART#	SIZE	W.L.L.	ROPE DIAMETER	OVERALL LENGTH	DESCRIPTION
80350	3"	1/2 Ton	8 mm (5/16")	11"	Loop
80355	4"	1 Ton	10 mm (3/8")	13"	Loop



Single Pulley Block With Eye

PART#	SIZE	W.L.L.	ROPE DIAMETER	OVERALL LENGTH	DESCRIPTION
80360	3"	1/2 Ton	8 mm (5/16")	11"	Eye, Access Latch, Safety Latch & Grease Fitting



Access Latch



Grease Fitting

Sizes are approximate. Specifications subject to change without notice. **Not Recommended for overhead lifting.**





Heavy Duty Snatch Block With Hook

The hook swivels.

PART#	PULLEY DIAMETER	ROPE DIAMETER	W.L.L.	TON
80270	3"	3/8"	4,000 lb	2
80271	4-1/2"	1/2"	8,000 lb	4
80272	6"	3/4"	16,000 lb	8
80273	8"	3/4"	16,000 lb	8



Heavy Duty Snatch Block With Shackle

PART#	PULLEY DIAMETER	ROPE DIAMETER	W.L.L.	TON
80280	3"	3/8"	4,000 lb	2
80281	4-1/2"	1/2"	8,000 lb	4
80282	6"	3/4"	16,000 lb	8
80283	8"	3/4"	16,000 lb	8



Heavy Duty Snatch Block Tail Boards

PART#	PULLEY DIAMETER	ROPE DIAMETER	W.L.L.	TON
80290	3"	3/8"	4,000 lb	2
80291	4-1/2"	1/2"	8,000 lb	4
80292	6"	3/4"	16,000 lb	8
80293	8"	3/4"	16,000 lb	8



Trolleys

Rugged steel construction. Lifetime lubricated & sealed bearings. Proof tested and certified. Built-in bumper guards. Use on straight or curved tracks. Adjustable to various beams. To be used with I beams.

PART#	CAPACITY	BEAM WIDTH
80301	1 Ton	2-15/16 - 4-15/16"
80302	2 Ton	3-15/16 - 5-15/16"
80303	3 Ton	3-15/16 - 5-15/16"
80305	5 Ton	4-15/16 - 6-7/8"



Beam Clamps

Rugged steel construction. Proof tested & certified. Use on straight or curved tracks. Adjustable to various beams.

PART#	CAPACITY	BEAM WIDTH
80320	1 Ton	2-15/16 - 8-11/16"
80321	2 Ton	2-15/16 - 8-11/16"
80322	3 Ton	3-1/8 - 12-5/8"
80323	5 Ton	3-1/8 - 12-5/8"



Cable Pullers with Winch

Designed to lift, stretch, lower or pull heavy loads. Features double ratchet wheel brake system, and hooks with safety latches. Snatch block included.

PART#	SAFE WORKING CAPACITY	MAX. RATED CAPACITY	HOOK SIZE	CABLE DIAMETER	CABLE LENGTH	WEIGHT
11351	1/2 Ton	1 Ton	3/8"	5/32"	6.0 ft.	1.9 kg
11352	1 Ton	2 Ton	3/8"	5/32"	7.21 ft.	2.5 kg
11354	2 Ton	4 Ton	5/16"	7/32"	9.84 ft.	5.2 kg

Sizes are approximate. Specifications subject to change without notice. **Not Recommended for overhead lifting.**



Lever Hoists

Lightweight, compact and portable. Impact-resistant, rugged steel body construction. Features short, low effort, 360°rotating handle. Equipped with Easy Free chain, Latch-type swivel hooks, and high-tensile alloy chain.

PART#	RATED CAPACITY (TONS)	CHAIN DIA	LIFT	MINIMUM CLEARANCE	LENGTH	TEST LOAD (TONS)	REPLACEMENT HOOKS TOP PART#	REPLACEMENT HOOKS BOTTOM PART#
80259	1/4	3/16"	59"	10-5/8"	10-13/32"	1-5/8	80259-1	80259-2
80260	1/2	3/16"	59"	10-5/8"	10-13/32"	1-5/8	80260-1	80260-2
80261	3/4	7/32"	59"	11-13/32"	10-7/16"	1-1/8	80261-1	80261-2
80262	1	1/4"	59"	12-13/16"	10-7/16"	1-1/2	80262-1	80262-2
80263	1-1/2	9/32"	59"	14-3/16"	16-1/8"	2-1/4	80263-1	80263-2
80264	3	11/32"	59"	18-1/2"	16-1/8"	4-1/2	80264-1	80264-2

Chain Hoists

Lightweight, compact and portable. Impact-resistant, rugged steel body construction. Features short, low effort, 360°rotating handle. Equipped with Easy Free chain, Latch-type swivel hooks, and high-tensile alloy chain.

- *Steel Formed Case to protect both gear and hand chain wheel slides against external shock.*
- *Double Cover Protection to stop moisture and dirt from entering into the hand chain wheel case and the brake cover.*
- *Break Mechanism will activate instantly when operation is stopped, whether the load is light or heavy.*
- *Double Ratchet Pawls for extra safety. Should one pawl fail, the other restrains the load.*
- *Powder Metal Bushing to increase mechanical efficiency and reduce the hand chain pull strength.*
- *Load Chain Guide & Stripper to assure proper fit of load chain to load sheave. Also protects against dirt and moisture gathering in the load sheave.*
- *Slack End Anchorage that serves as a limit stopper to prevent any accidents caused by over-lowering heavy loads.*
- *Grade 80 Alloy Load Chain specially calibrated for hand chain block usage. All of the load chain meets or exceeds ISO and DIN standards.*
- *Hot forged, heat treated, swivel hooks with safety latches to ensure proper hooking to the load or sling.*

PART#	STANDARD RATED W.L.L.	LIFT	HEADROOM	HANDLE EFFORT	TEST LOAD (TONS)	REPLACEMENT TOP HOOKS	REPLACEMENT BOTTOM HOOKS
80250	1/2 Ton	8.2'	10-3/4"	48 lb	3/4	80250-1	80250-2
80251	1 Ton	8.2'	11-3/4"	57 lb	1-1/2	80251-1	80251-2
80252	1-1/2 Ton	9.8'	14-3/4"	66 lb	2-1/4	80252-1	80252-2
80253	2 Ton	9.8'	14-3/4"	77 lb	3	80253-1	80253-2
80254	3 Ton	9.8'	20-3/4"	77 lb	4-1/2	80254-1	80254-2



Sizes are approximate. Specifications subject to change without notice. **Not Recommended for overhead lifting.**





GENERAL HARDWARE



A		Merchandiser - Turnbuckles	254
Adjustable Clevis Pins	275	Merchandiser - U-Bolts	253
Aluminum Snap Links	273	Mounting Rings	264
Aluminum Spring Snap	268	O	
B		Open Decoy Snaps	271
Baby Square Eye Snaps	271	Open Eye Snaps	271
Bolt Snaps	270	P	
Bronze Animal Snap	272	Packaged Compression Springs	280, 281
Bull Snap	269	Packaged Extension Springs	277, 278, 279
C		Panic Snap	272
Cap Snap	269	R	
Carabiner with Magnet	273	Rectangular Keystock	274
Clevis Pin Dynapaks	275	Replacement Sheaves	261
Clevis Pins	275	S	
Cornice Hooks	262	Safety Lanyard Snaps	268
D		Screw Hooks	262
Dog Lead Snap	269	Security Snaps	272
Double Hook With Swivel Eye	260	S-Hooks	261
Die Cast Awning Pulleys	259	Shoulder Eyebolts	263
Drawbar Spring	279	Single Fixed - Die Cast Awning Pulleys	258
D-Rings	265	Single Hook - Steel Pulley Blocks	260
E		Single Swivel - Die Cast Awning Pulleys	259
E Retainer Rings	282	Solid - Die Cast Aluminum Pulleys	258
External Retainer Rings	284	Solid Snap Hook	269
Eye & Eye Turnbuckles	266, 267	Split Key Rings	265
Eye Bull Snaps	272	Spoked - Die Cast Aluminum Pulleys	258
Eyebolts	263	Spring Snap	271
F		Square Keystock	274
Fixed - Steel Pulley Blocks	259, 260	Stainless Steel Bolt Snaps	268
Flat Spring Snap	272	Stainless Steel Security Snaps	268
G		Stainless Steel Snap Links	273
Galvanized Dock Rope Cleat	273	Stainless Steel Spring Snaps	268
H		Stake Eye - Stake Rack Hardware	261
Harness Ring	265	Stake Hooks - Stake Rack Hardware	261
Heavy Duty D-Rings	265	Stake Pocket	261
Hook & Eye Turnbuckles	265, 267	Steel Snap Links	273
Hook & Hook Turnbuckles	266	T	
I		Step Keystock	274
Internal Retainer Rings	283	Swivel - Steel Pulley Blocks	259
J		Swivel Eye - Steel Pulley Blocks	260
Jaw & Jaw Turnbuckles	267	Swivel Eye Snaps	269
K		Swivel Loop Snaps	271
Keystocks	256	Swivel Security Snaps	272
L		Swivel Snaps	271
Lagscrew Eyebolts	263	U	
Lever Snaps	272	U-Bolts - Round	264
Loop Snaps	271	U-Bolts - Square	264
M		V	
Machinery Bushings	276	Variable Speed - Die Cast Aluminum Pulleys	258
Merchandiser - Aluminum Pulleys	254	W	
Merchandiser - Eyebolts & Rings	252	Welded Steel Ring	265
Merchandiser - General Hardware	252, 257		
Merchandiser - Machinery Bushings	256		
Merchandiser - Pulley Blocks	253		
Merchandiser - Retainer Rings	256		
Merchandiser - Retainer Rings Tilt Bins	257		
Merchandiser - Snaps	252, 255		
Merchandiser - Springs	256		





General Hardware



Your Trusted Source.

Dynaline General Hardware Merchandisers

Dynaline offers merchandisers for almost every product. Merchandisers keep your stock organized, visible and easy to shop.

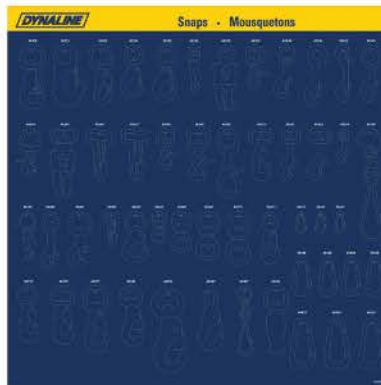

General Hardware Merchandiser

PART#	CONTENTS
01081	General Hardware Backdrop Only , 48" x 48"
01081K	Full General Hardware Planogram . Includes 01081 and the products.

i Full product breakdown on page 41

Snaps Merchandiser

PART#	CONTENTS
00448	Snaps Display Board Only , 24" x 24"
00448K	Full Snaps Merchandiser . Includes 00448 display board, 52 pegs (80004) and products.

i Full product breakdown on page 43

Eyebolts & Rings Merchandiser

PART#	CONTENTS
00611	Eyebolts & Rings Display Board Only , 24" x 24"
00611K	Full Eyebolts & Rings Merchandiser . Includes 00611 display board, 47 pegs (80004) and the products.

i Full product breakdown on page 44

Sizes are approximate. Specifications subject to change without notice.



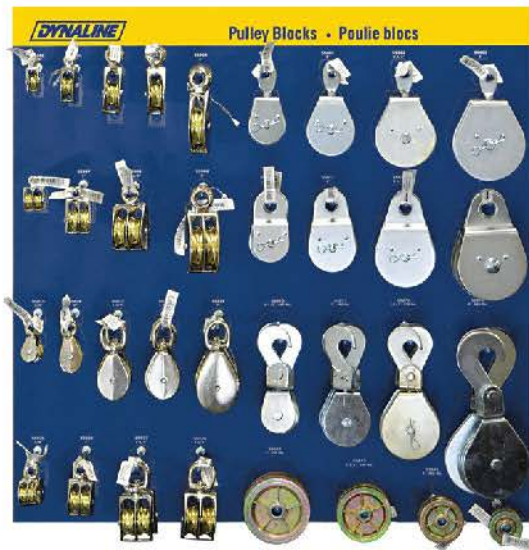
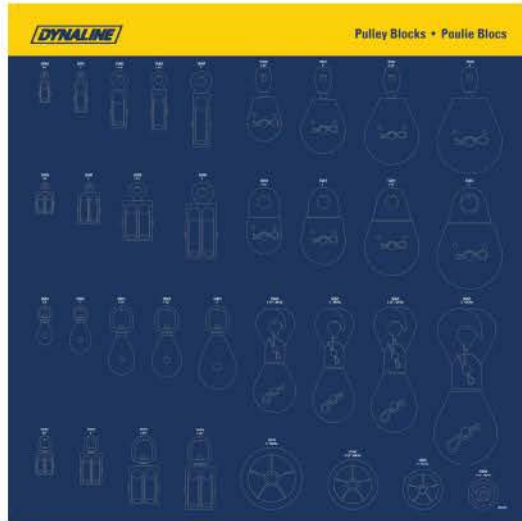

Pulley Blocks Merchandiser

PART#	CONTENTS
00334	Pulley Blocks Display Board Only , 24" x 24"
00334K	Full Pulley Blocks Merchandiser . Includes 00334 display board, 34 pegs (80004) and the products.



i Full product breakdown on page 46

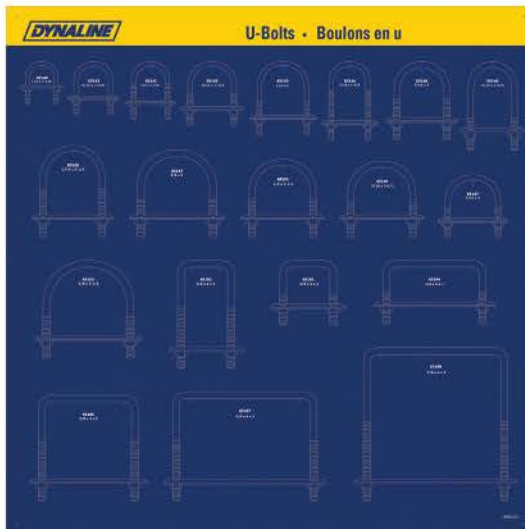

U-Bolts Merchandiser

PART#	CONTENTS
00612	U-Bolts Display Board Only , 24" x 24"
00612K	Full U-Bolts Merchandiser . Includes 00612 display board, 26 pegs (80004) and the products.



i Full product breakdown on page 45

Sizes are approximate. Specifications subject to change without notice.



General Hardware

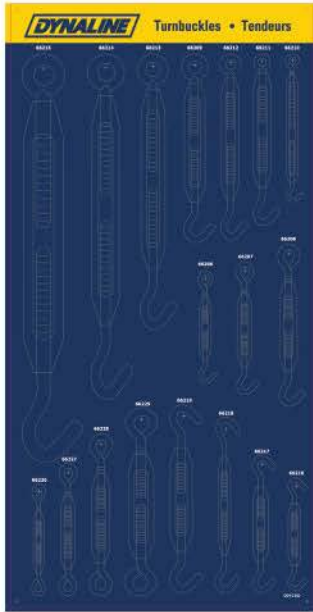

Turnbuckles Merchandiser - General Purpose

PART#	CONTENTS
00416	Turnbuckles Display Board Only , 12" x 24"
00416K	Full General Purpose Turnbuckles Merchandiser. Includes 00416 display board, 19 pegs (80004) and products.

i Full product breakdown on page 48



Aluminum Pulleys Merchandiser

PART#	CONTENTS
00335	Aluminum Pulley Display Boards Only , two 24" x 24"
00335K	Full Aluminum Pulleys Merchandiser. Includes two 00335 display boards, 36 pegs (80004) and the products below:

i Full product breakdown on page 47

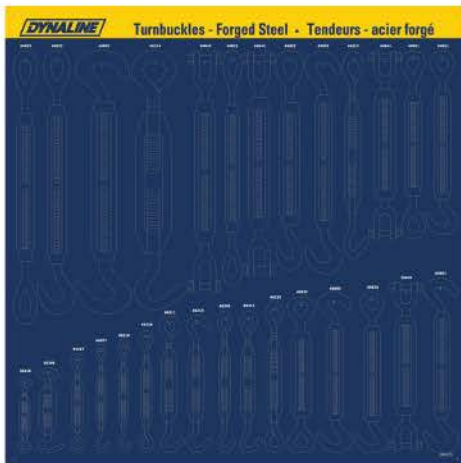

Turnbuckles Merchandiser - Forged Steel

PART#	CONTENTS
00417	Forged Steel Turnbuckles Display Board Only , 24" x 24"
00417K	Full Forged Steel Turnbuckles Merchandiser. Includes 00417 display board, 30 pegs (80004) and products.

i Full product breakdown on page 48

Sizes are approximate. Specifications subject to change without notice.





Snaps Merchandiser

PART#	CONTENTS
00447	Snaps Display Board Only, 12" x 24"
00447K	Full Snaps Merchandiser. Includes 00447 display board, 33 pegs (80004) and products.

i Full product breakdown on page 50

00024 Compatible

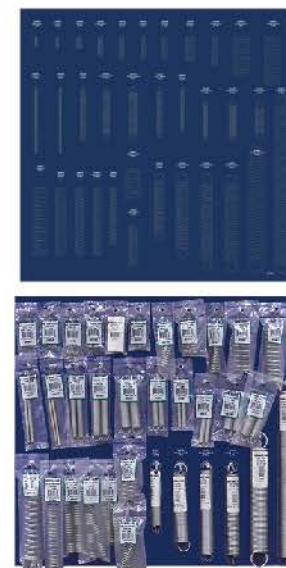
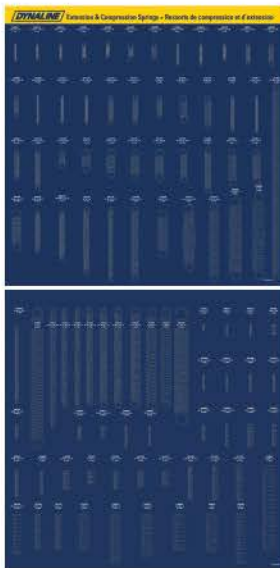

00024 Compatible

00024 Compatible

Springs Merchandiser - Retail Packaged

PART#	CONTENTS
00242	Springs Display Boards Only. Includes two 24" x 24" full color boards.
00242K	Full Springs Merchandiser. Includes 00242 display boards, 100 pegs (80004) and products.

i Full product breakdown on page 51

Springs - Expanded Selection 1

PART#	CONTENTS
00244	Springs Display Board Only, 24" x 24"
00244K	Full Springs Merchandiser Expansion 1 for 00242K. Includes 00242 display board, 34 pegs (80004) and products.

i Full product breakdown on page 52

Sizes are approximate. Specifications subject to change without notice





General Hardware

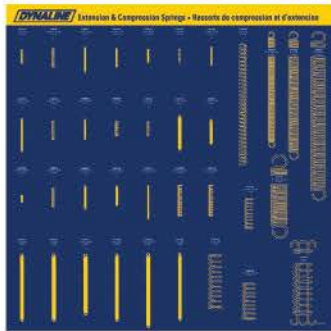

Springs - Expanded Selection 2

PART#	CONTENTS
-------	----------

00248 Springs **Display Board Only**, 24" x 24"

00248K **Full Springs Merchandiser Expansion 2** for 00242K. Includes 00248 display board, 36 pegs (80004) and products.

Full product breakdown on page 52



Retainer Rings Merchandiser

PART#	CONTENTS
-------	----------

00245 Retainer Rings **Display Board Only**, 24" x 24"

00245K **Full Retainer Rings Merchandiser.** Includes 00245 display board, cornice hooks (65043) and products.

Full product breakdown on page 53



Machinery Bushings Merchandiser

PART#	CONTENTS
-------	----------

00235 Machinery Bushings **Display Board Only**, 12" x 24"

00235K **Full Machinery Bushings Merchandiser.** Includes 00235 display board, 39 pegs (80004) and products.

Full product breakdown on page 55



Keystock



00285

PART#	CONTENTS
-------	----------

00285 **Keystock Bin only.** 8 compartments, made of durable blue plastic. Dimensions: 10" x 9-1/8" x 1-1/2"



00255K

PART#	CONTENTS
-------	----------

00255K **Full Square Keystock Merchandiser.** 37 pieces, 12" long / 6 part #'s. Includes 00285 Keystock Bin.

PART#	CONTENTS
-------	----------

00265K **Full Rectangular Keystock Merchandiser.** 37 pieces, 12" long / 8 part #'s. Includes 00285 Keystock Bin.

PART#	CONTENTS
-------	----------

00275K **Full Step Keystock Merchandiser.** 16 pieces, 12" long / 8 part #'s. Includes 00285 Keystock Bin

Full product breakdown on page 55

Sizes are approximate. Specifications subject to change without notice.



Retainer Rings Tilt Bins Merchandiser

PART#	CONTENTS
-------	----------

00746K Full Retainer Rings Tilt Bin Merchandiser. Dimensions: 23-5/8" x 2-1/2" x 26-1/2"
Includes Tilt Bins, assembly hardware and the products.

i Full product breakdown on page 54

For empty tilt bins, see the end of this merchandiser section.

General Hardware Bulk Merchandiser

PART#	CONTENTS
-------	----------

00028 Bulk Display Rack Only - 72" x 32" x 24" - 7 shelves

00034K Full Merchandiser. 255 part #'s, 1930 pieces. Includes: 4 sign headers, bulk bin interlocking displays, bin labels.

i Full product breakdown on page 10



Sizes are approximate. Specifications subject to change without notice.





General Hardware



Solid - Die Cast Aluminum Pulleys

Single groove for 3L, 4L or "A" belts. Supplied with 5/16" x 1/2" UNC set screws.

PART#	OUTSIDE DIAMETER	BORE	KEYWAY	PART#	OUTSIDE DIAMETER	BORE	KEYWAY
<input type="checkbox"/> 55400	1-1/2"	1/2"	No	<input type="checkbox"/> 55413	3"	3/4"	Yes
<input type="checkbox"/> 55401	1-1/2"	5/8"	No	<input type="checkbox"/> 55414	3-1/2"	1/2"	No
<input type="checkbox"/> 55402	2"	1/2"	No	<input type="checkbox"/> 55415	3-1/2"	5/8"	Yes
<input type="checkbox"/> 55403	2"	5/8"	Yes	<input type="checkbox"/> 55416	3-1/2"	3/4"	Yes
<input type="checkbox"/> 55404	2"	3/4"	Yes	<input type="checkbox"/> 55417	4"	1/2"	No
<input type="checkbox"/> 55405	2-1/4"	1/2"	No	<input type="checkbox"/> 55418	4"	5/8"	Yes
<input type="checkbox"/> 55406	2-1/4"	5/8"	Yes	<input type="checkbox"/> 55419	4"	3/4"	Yes
<input type="checkbox"/> 55407	2-1/4"	3/4"	Yes	<input type="checkbox"/> 55420	4-1/2"	1/2"	No
<input type="checkbox"/> 55408	2-1/2"	1/2"	No	<input type="checkbox"/> 55421	4-1/2"	5/8"	Yes
<input type="checkbox"/> 55409	2-1/2"	5/8"	Yes	<input type="checkbox"/> 55422	4-1/2"	3/4"	Yes
<input type="checkbox"/> 55410	2-1/2"	3/4"	Yes	<input type="checkbox"/> 55423	5"	1/2"	No
<input type="checkbox"/> 55411	3"	1/2"	No	<input type="checkbox"/> 55424	5"	5/8"	Yes
<input type="checkbox"/> 55412	3"	5/8"	Yes	<input type="checkbox"/> 55425	5"	3/4"	Yes



Spoked - Die Cast Aluminum Pulleys

PART#	OUTSIDE DIAMETER	BORE	KEYWAY	PART#	OUTSIDE DIAMETER	BORE	KEYWAY
<input type="checkbox"/> 55426	6"	1/2"	No	<input type="checkbox"/> 55430	7"	5/8"	Yes
<input type="checkbox"/> 55427	6"	5/8"	Yes	<input type="checkbox"/> 55431	7"	3/4"	Yes
<input type="checkbox"/> 55428	6"	3/4"	Yes	<input type="checkbox"/> 55433	8"	5/8"	Yes
<input type="checkbox"/> 55429	7"	1/2"	No	<input type="checkbox"/> 55434	8"	3/4"	Yes



Variable Speed - Die Cast Aluminum Pulleys

Solid type. For "A" & "B" belts. Opening the pulley increases the speed at which it rotates. Supplied with set screws.

PART#	OUTSIDE DIAMETER	BORE	KEYWAY
<input type="checkbox"/> 55490	3-1/4"	1/2"	No
<input type="checkbox"/> 55491	3-1/4"	5/8"	Yes
<input type="checkbox"/> 55492	3-1/4"	3/4"	Yes



Single Fixed - Die Cast Awning Pulleys

PART#	PULLEY DIAMETER	ROPE DIAMETER	EYE DIAMETER	W.L.L.
<input type="checkbox"/> 55900	3/4"	up to 3/16"	3/16"	65 lb
<input type="checkbox"/> 55901	1"	up to 1/4"	1/4"	110 lb
<input type="checkbox"/> 55902	1-1/4"	up to 3/8"	3/8"	165 lb
<input type="checkbox"/> 55903	1-1/2"	up to 3/8"	3/8"	220 lb
<input type="checkbox"/> 55904	2"	up to 1/2"	1/2"	330 lb

Sizes are approximate. Specifications subject to change without notice.



Double Fixed - Die Cast Awning Pulleys

-
-
-
-

PART#	PULLEY DIAMETER	ROPE DIAMETER	EYE DIAMETER	W.L.L.
55906	3/4"	up to 3/16"	3/16"	65 lb
55907	1"	up to 1/4"	3/16"	110 lb
55908	1-1/2"	up to 3/8"	3/8"	220 lb
55909	2"	up to 1/2"	1/2"	330 lb



Single Swivel - Die Cast Awning Pulleys

-
-
-
-
-

PART#	PULLEY DIAMETER	ROPE DIAMETER	EYE DIAMETER	W.L.L.
55915	3/4"	up to 3/16"	1/2"	65 lb
55916	1"	up to 1/4"	7/16"	110 lb
55917	1-1/4"	up to 3/8"	13/16"	165 lb
55918	1-1/2"	up to 3/8"	13/16"	220 lb
55919	2"	up to 1/2"	13/16"	330 lb



Double Swivel - Die Cast Awning Pulleys

-
-
-
-

PART#	PULLEY DIAMETER	ROPE DIAMETER	EYE DIAMETER	W.L.L.
55925	3/4"	up to 3/16"	7/16"	65 lb
55926	1"	up to 1/4"	7/16"	110 lb
55927	1-1/4"	up to 3/8"	13/16"	165 lb
55928	1-1/2"	up to 3/8"	13/16"	220 lb



Swivel - Steel Pulley Blocks

-
-
-
-

PART#	SHEAVE DIAMETER	LENGTH	ROPE DIAMETER	EYE DIAMETER	W.L.L.
55800	1-1/2"	3-1/2"	up to 3/8"	3/8"	460 lb
55801	2"	4"	up to 3/8"	3/8"	480 lb
55802	2-1/2"	4-1/2"	up to 3/8"	3/8"	550 lb
55803	3"	4-3/4"	up to 1/2"	3/8"	650 lb



Fixed - Steel Pulley Blocks

-
-
-
-

PART#	SHEAVE DIAMETER	LENGTH	ROPE DIAMETER	EYE DIAMETER	W.L.L.
55810	1-1/2"	3-1/4"	up to 3/8"	1/2"	420 lb
55811	2"	3-3/4"	up to 3/8"	1/2"	480 lb
55812	2-1/2"	4-1/4"	up to 3/8"	1/2"	550 lb
55813	3"	4-3/4"	up to 3/8"	3/4"	650 lb



Sizes are approximate. Specifications subject to change without notice.



Swivel Eye - Steel Pulley Blocks (Deuer Type)

PART#	DIAMETER	LENGTH	MAXIMUM CABLE DIAMETER	EYE DIAMETER	W.L.L.
55850	1-1/2"	3-1/2"	3/16"	3/8"	460 lb
55851	2"	4-1/2"	3/16"	3/8"	480 lb
55852	2-1/2"	5"	1/4"	3/8"	550 lb
55853	3"	4-3/4"	1/4"	3/8"	650 lb



Fixed Eye - Steel Pulley Blocks (Deuer Type)

PART#	DIAMETER	LENGTH	MAXIMUM CABLE DIAMETER	EYE DIAMETER	W.L.L.
55860	1-1/2"	3-1/4"	3/16"	1/2"	420 lb
55861	2"	3-3/4"	3/16"	1/2"	480 lb
55862	2-1/2"	4-1/4"	1/4"	1/2"	550 lb
55863	3"	4-3/4"	1/4"	3/4"	650 lb



Double Hook With Swivel Eye - Steel Pulley Blocks (Deuer Type)

PART#	DIAMETER	LENGTH	MAXIMUM CABLE DIAMETER	W.L.L.
<input type="checkbox"/> 55870	1-1/2"	5"	3/16"	460 lb
<input type="checkbox"/> 55871	2"	5-1/2"	3/16"	480 lb
<input type="checkbox"/> 55872	2-1/2"	6"	1/4"	550 lb
<input type="checkbox"/> 55873	3"	7-1/2"	1/4"	650 lb



Single Hook - Steel Pulley Blocks (Deuer Type)

PART#	DIAMETER	LENGTH	MAXIMUM CABLE DIAMETER	W.L.L.
55880	1-1/2"	5"	3/16"	460 lb
55881	2"	5-1/2"	3/16"	480 lb
55882	2-1/2"	6"	1/4"	550 lb
55883	3"	7-1/2"	1/4"	650 lb

Sizes are approximate. Specifications subject to change without notice.



Replacement Sheaves

For heavy duty pulley blocks. Bronze bushing bore.

PART#	SHEAVE DIAMETER	BORE SIZE	W.L.L.
55890	1-1/2"	5/16"	460 lb
55891	2"	5/16"	480 lb
55892	2-1/2"	5/16"	550 lb
55893	3"	5/16"	650 lb
55840	1-1/2"	5/16"	420 lb
55841	2"	5/16"	480 lb
55842	2-1/2"	5/16"	550 lb
55843	3"	7/16"	650 lb



Stake Hooks - Stake Rack Hardware

Ductile iron. Clear zinc plated finish. Rockwell hardness: 5.4 – 18 (HRC).

PART#	DESCRIPTION	PIN LENGTH	PIN DIAMETER
23050	Left-Hand	3"	9/16"
23051	Right-Hand	3"	9/16"
23052	Left-Hand	6"	9/16"
23053	Right-Hand	6"	9/16"



Stake Eye - Stake Rack Hardware

PART#	EYE INSIDE DIAMETER
23054	5/8"



Stake Pocket

PART#	DESCRIPTION
102395	Stake pocket, 1-1/2" x 3-1/4" opening x 2-1/4" high powder coat finish, black



S-Hooks

Clear zinc plated finish.

BAG PACKAGE		DYNAPAK PACKAGE		WIRE DIAMETER	OVERALL LENGTH
PART#	PACKAGE QUANTITY	PART #	PACKAGE QUANTITY		
66230	10	96230	10	0.093" (3/32")	1"
66232	10	96232	10	0.105" (7/64")	1-3/32"
66234	10	96234	10	0.120" (1/8")	1-3/8"
66235	10	96235	10	0.162" (5/32")	1-1/2"
66236	10	96236	6	0.141" (9/64")	2-1/8"
66238	10	96238	6	0.250" (1/4")	2-5/8"
66239	10	96239	6	0.188" (3/16")	3"





Sizes are approximate. Specifications subject to change without notice.



Tarp Hooks

Zinc plated formed steel.

PART#	WIRE DIAMETER	OVERALL LENGTH	PACKAGE QUANTITY
 66423	3/8"	3-1/2"	10
 66424	1/4"	2-1/2"	10

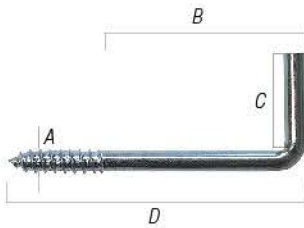

Cornice Hooks

Clear zinc plated finish.

PART#	A	B	C	D	PACKAGE QUANTITY
65040	9/32"	1-3/4"	1"	3-1/16"	10
65041	3/16"	1-5/8"	7/8"	2-5/8"	10
65042	5/32"	1-3/8"	13/16"	2-1/4"	10
65043	1/8"	1-1/8"	11/16"	1-13/16"	10
65044	3/32"	3/4"	1/2"	1-3/8"	10

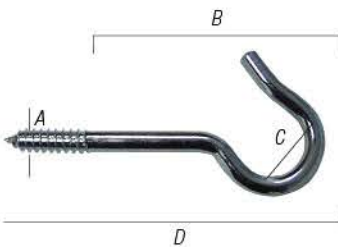

Screw Hooks

Clear zinc plated finish.

PART#	A	A (DECIMAL)	B	C	C (DECIMAL)	D	PACKAGE QUANTITY
65070	1/4"	0.25"	3-1/16"	1-1/32"	1.03	4-5/16"	10
65071	7/32"	0.21"	3-3/16"	1"	25.4	4-7/16"	10
65072	3/16"	0.19"	2-5/8"	27/32"	84.38	3-7/8"	10
65073	5/32"	0.158"	2-1/8"	11/16"	17.44	3-3/8"	10
65074	1/8"	0.138"	2-9/16"	1/2"	13.2	2-9/16"	10
65075	7/64"	0.112"	2-1/16"	13/32"	0.41	2-1/16"	10
65076	3/32"	0.086"	1-1/16"	9/32"	0.28	1-11/16"	10
65077	5/64"	0.073"	3/4"	15/16"	0.94	1-5/16"	10

Sizes are approximate. Specifications subject to change without notice.

Lagscrew Eyebolts

Clear zinc plated finish.

	PART#	A	B	C	D	E	PACKAGE QUANTITY
	65161	1/4"	1-5/16"	2-3/4"	3-3/4"	1/2"	10
	65162	1/4"	1-7/8"	4"	5"	1/2"	10
	65163	5/16"	1-7/8"	2-3/4"	4"	5/8"	10
	65164	5/16"	1-7/8"	4-3/4"	6"	5/8"	10
	65165	3/8"	1-15/16"	3"	4-1/2"	3/4"	10
	65166	3/8"	2-7/8"	6-1/2"	8"	3/4"	10

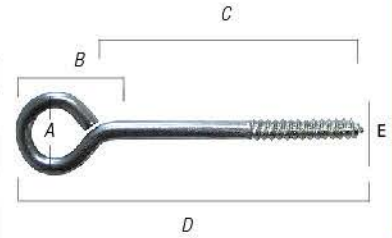

Shoulder Eyebolts

Forged steel. Galvanized finish. Supplied with nut. Sold individually.

	PART#	A	B	C	D	E	W.L.L.
	66100	1/4"	1-1/2"	2"	3"	1/2"	500 lb
	66101	5/16"	1-1/2"	2-1/4"	3-1/2"	5/8"	800 lb
	66102	3/8"	1-1/2"	2-1/2"	4"	3/4"	1,200 lb
	66103	1/2"	1-1/2"	3-1/4"	5-1/4"	1"	2,200 lb
	66104	5/8"	1-3/4"	4"	6-1/2"	1-1/4"	3,500 lb
	66105	1/4"	2-1/2"	4"	5"	1/2"	500 lb
	66106	5/16"	2-1/2"	4-1/4"	5-1/2"	5/8"	800 lb
	66107	3/8"	2-1/2"	6"	7-1/2"	3/4"	1,200 lb
	66108	1/2"	3"	6"	7-3/4"	1"	2,200 lb

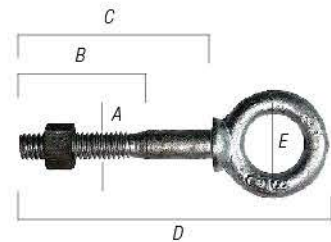

Eyebolts

Wire Formed. Supplied with Nut. Zinc plated finish.

	PART#	A	B	C	D	E	PACKAGE QUANTITY
	65102	3/16"	1"	1-3/8"	2"	3/8"	10
	65104	3/16"	1-5/8"	1-3/4"	2-1/2"	3/8"	10
	65106	1/4"	1"	1"	2"	9/16"	10
	65107	1/4"	1-3/8"	1-1/2"	2-1/2"	9/16"	10
	65108	1/4"	1-3/4"	2"	3"	9/16"	10
	65109	1/4"	2-3/4"	3"	4"	9/16"	10
	65110	1/4"	3"	4"	5"	9/16"	10
	65111	1/4"	3"	5"	6"	9/16"	10
	65112	5/16"	1-3/4"	2"	3-1/4"	3/4"	10
	65113	5/16"	2-3/16"	2-1/2"	4"	3/4"	10
	65114	5/16"	3"	3-1/2"	5"	3/4"	10
	65115	5/16"	3"	4-1/2"	6"	3/4"	10
	65117	3/8"	2"	2-1/4"	4"	1"	10
	65118	3/8"	3"	3-1/4"	5"	1"	10
	65119	3/8"	3"	4-1/4"	6"	1"	10
	65120	3/8"	3"	6-1/4"	8"	1"	10
	65123	1/2"	3"	3-3/4"	6"	1-1/4"	10
	65124	1/2"	3"	5-3/4"	8"	1-1/4"	10

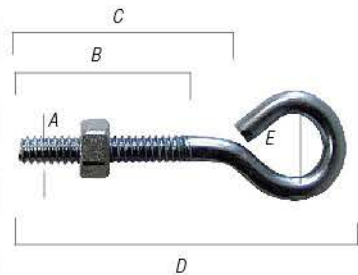

Sizes are approximate. Specifications subject to change without notice.

Legend: 12x24 24x24 Plan-0-Gram Rack/End Cap Other





U-Bolts - Round

Q235 Steel-Grade 2. Supplied with 3/32" mounting plate & nuts. Clear zinc plated. 10 pieces per package. UNC threading (coarse).

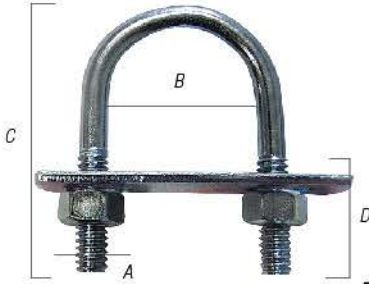

PART#	A	B	C	D	THREADS / INCH	PIPE
65140	1/4"	1-1/8"	2"	1"	20	3/4"
65141	1/4"	1-3/8"	2-3/4"	1-1/4"	20	1"
65142	1/4"	2"	3-1/2"	1-3/4"	20	1-1/2"
65143	5/16"	1-3/8"	2-1/2"	1"	18	1"
65144	5/16"	1-3/8"	3-11/16"	2-3/8"	18	1"
65145	5/16"	1-3/4"	3"	1-1/2"	18	1-1/4"
65146	5/16"	1-3/4"	4-3/16"	2-3/4"	18	1-1/4"
65147	5/16"	2"	3"	1-1/2"	18	1-1/2"
65148	5/16"	2"	3-3/4"	2-1/8"	18	1-1/2"
65149	5/16"	2-1/2"	3-1/2"	1-1/2"	18	2"
65150	5/16"	2-1/2"	4-3/16"	2-3/8"	18	2"
65151	3/8"	2-1/2"	3-5/8"	1-3/4"	16	2"
65152	3/8"	3"	4-1/8"	1-3/4"	16	2-1/2"
65153	3/8"	3-1/2"	4-5/8"	2"	16	3"

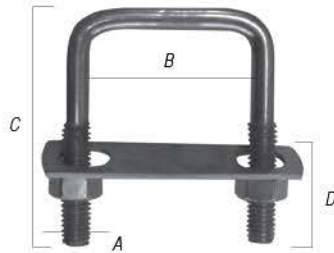
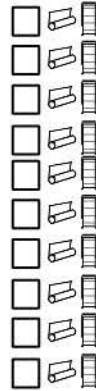

U-Bolts - Square

Q235 Steel-Grade 2. Supplied with 3/32" mounting plate & nuts. Clear zinc plated. 5 pieces per package. UNC Threading (coarse).

PART#	A	B	C	D
65181	3/8"	2"	3"	1-1/2"
65182	3/8"	2"	5"	3"
65184	3/8"	4"	3"	1-1/2"
65185	3/8"	4"	5"	3"
65187	3/8"	6"	5"	3"
65188	3/8"	6"	7"	3-3/4"

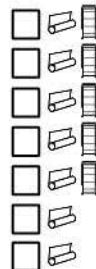

65172



65177



65178

Mounting Rings

Clear zinc plated. 10 pieces per package.

PART#	DESCRIPTION	PIN DIAMETER	THREAD LENGTH	RING I.D.	ADDITIONAL INFORMATION
65172	4-1/4" Eyebolt Length	3/8"	2-1/2"	2"	Supplied with nut
65177	4-1/2" Lagscrew Eyebolt Length	5/16"	2"	2"	N/A
65178	2" x 1-9/16" Mounting Plate			2"	Mounting holes are 1/4" Diameter

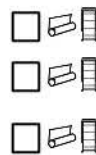

Sizes are approximate. Specifications subject to change without notice.

D-Rings

	PART#	WIRE DIAMETER	A	B	PACKAGE QUANTITY
	66173	1/8"	1"	7/8"	10
	66174	1/8"	1-1/8"	7/8"	10
	66175	5/32"	1-5/16"	1"	10
	66176	5/32"	1-5/8"	1-1/8"	10

Heavy Duty D-Rings

	PART#	WIRE DIAMETER	A	B	PACKAGE QUANTITY
	66178	5/16"	2"	1-3/4"	10
	66179	3/8"	2"	1-7/8"	10

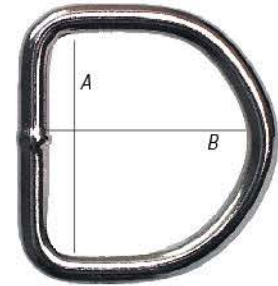

Split Key Rings

	PART#	WIRE DIAMETER	INSIDE DIAMETER	OUTSIDE DIAMETER	PACKAGE QUANTITY
	66180	0.066"	5/8"	3/4"	10
	66182	0.075"	27/32"	1"	10
	66184	0.087"	1-5/64"	1-1/4"	10



Harness Ring

	PART#	WIRE DIAMETER	INSIDE DIAMETER	OUTSIDE DIAMETER	PACKAGE QUANTITY
	66390	3/16"	1-1/4"	1-5/8"	5



Welded Steel Ring

	PART#	WIRE DIAMETER	INSIDE DIAMETER	OUTSIDE DIAMETER	W.L.L.	PACKAGE QUANTITY
	66410	1/4"	1"	1-1/2"	200 lb	10
	66411	5/16"	1-1/8"	1-3/4"	250 lb	10
	66412	7/32"	1-9/16"	2"	200 lb	10



Hook & Eye Turnbuckles (Wire Formed Ends)

For light duty applications. Zinc die cast bodies. Zinc plated steel wire formed ends. 10 pieces per package.

	PART#	THREAD	OVERALL LENGTH CLOSED	OVERALL LENGTH OPEN	A	B	C	W.L.L.	U.L.L.
	66206	7/32"	4-1/2"	6-1/2"	3/8"	5/16"	2"	120 lb	350. lb
	66207	1/4"	5-3/8"	7-11/16"	7/16"	3/8"	2-3/8"	190 lb	570 lb
	66208	5/16"	6-1/2"	9-5/16"	7/16"	9/16"	2-13/16"	290 lb	875 lb
	66209	3/8"	7-1/2"	10-5/8"	5/8"	9/16"	3-1/8"	375 lb	1,125 lb



Sizes are approximate. Specifications subject to change without notice.

Legend: 12x24 24x24 Plan-O-Gram Rack/End Cap Other





Hook & Hook Turnbuckles (Wire Formed Ends)

For light duty applications. Zinc die cast bodies. Zinc plated steel wire formed ends. 10 pieces per package.

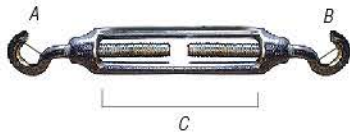

-
-
-
-

PART#	THREAD	OVERALL LENGTH CLOSED	OVERALL LENGTH OPEN	A, B	C	W.L.L.	U.L.L.
66216	7/32"	4-1/2"	6-1/2"	5/16"	2"	120 lb	350 lb
66217	1/4"	5-1/2"	7-9/16"	7/16"	2-3/8"	190 lb	570 lb
66218	5/16"	6-1/2"	6-1/4"	7/16"	2-13/16"	340 lb	1,020 lb
66219	3/8"	7"	10-5/8"	1/2"	3-1/8"	400 lb	1,200 lb

Eye & Eye

For light duty applications. Zinc die cast bodies. Zinc plated steel wire formed ends. 10 pieces per package.



-
-
-
-

PART#	THREAD	OVERALL LENGTH CLOSED	OVERALL LENGTH OPEN	A, B	C	W.L.L.	U.L.L.
66226	3/16"	4-1/2"	6-1/2"	3/8"	2"	120 lb	350 lb
66227	1/4"	5-1/2"	7-9/16"	3/8"	2-3/8"	190 lb	570 lb
66228	5/16"	6-1/2"	9-1/4"	7/16"	2-3/4"	340 lb	1,020 lb
66229	3/8"	7"	10-5/8"	1/2"	3-1/8"	400 lb	1,200 lb

Hook & Eye Turnbuckles (Malleable Iron)

Malleable iron bodies and forged steel ends. Hot dipped galvanized finish.

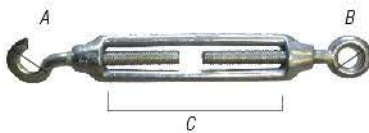

-
-
-
-
-
-
-

PART#	THREAD	OVERALL LENGTH CLOSED	OVERALL LENGTH OPEN	A, B	C	W.L.L.	U.L.L.
66210	6mm	5-3/16"	8-1/16"	3/8"	2-3/4"	132 lb	396 lb
66211	8mm	6-1/2"	9-1/16"	7/16"	3-9/16"	264 lb	792 lb
66212	10mm	7-5/16"	10-1/4"	15/32"	3-3/4"	396 lb	1,188 lb
66213	12mm	10-7/16"	16"	19/32"	5-1/2"	726 lb	2,178 lb
66214	16mm	13-3/8"	19-11/16"	3/4"	7-1/8"	1,320 lb	3,960 lb
66215	20mm	15-3/4"	22-1/16"	1"	8-1/4"	1,980 lb	5,940 lb

Hook & Hook Turnbuckles (Forged Steel)

Forged steel bodies & ends. Hot dipped galvanized finish. Features a lock nut on each end. Meets Spec. FF-T791b, Type 1, Form 1, Class 5.



-
-
-
-

PART#	THREAD	OVERALL LENGTH CLOSED	OVERALL LENGTH OPEN	A, B	C	W.L.L.	U.L.L.
66800	1/4"	8"	12"	7/16"	4"	400 lb	2,000 lb
66801	5/16"	9-1/4"	13-3/4"	1/2"	4-1/2"	700 lb	3,500 lb
66802	3/8"	11-3/4"	17-3/4"	9/16"	6"	1,000 lb	5,000 lb
66803	1/2"	13-3/8"	20-3/8"	11/16"	6"	1,500 lb	7,500 lb
66804	1/2"	16-3/8"	26-3/8"	11/16"	9"	1,500 lb	7,500 lb
66805	1/2"	19-3/8"	32-3/8"	11/16"	12"	1,500 lb	7,500 lb
66806	5/8"	15-1/4"	22-1/2"	7/8"	6"	2,250 lb	11,250 lb
66807	5/8"	18-1/4"	28-1/2"	7/8"	9"	2,250 lb	11,250 lb
66808	5/8"	21-1/4"	34-1/2"	7/8"	12"	2,250 lb	11,250 lb
66809	3/4"	17-1/4"	24-3/4"	1"	6"	3,000 lb	15,000 lb
66810	3/4"	20-1/4"	30-3/4"	1"	9"	3,000 lb	15,000 lb
66811	3/4"	23-1/4"	36-3/4"	1"	12"	3,000 lb	15,000 lb

Sizes are approximate. Specifications subject to change without notice.



Hook & Eye Turnbuckles (Forged Steel)

Forged steel bodies & ends. Hot dipped galvanized finish. Features a lock nut on each end. Meets Spec. FF-T791b, Type 1, Form 1, Class 6.

	PART#	THREAD	OVERALL LENGTH CLOSED	OVERALL LENGTH OPEN	A	B	C	W.L.L.	U.L.L.
<input type="checkbox"/>	66820	1/4"	8"	12"	11/32"	7/16"	3-3/4"	400 lb	2,000 lb
<input type="checkbox"/>	66821	5/16"	9-1/2"	13-1/2"	7/16"	1/2"	4-1/2"	700 lb	3,500 lb
<input type="checkbox"/>	66822	3/8"	12"	18"	17/32"	9/16"	6"	1,000 lb	5,000 lb
<input type="checkbox"/>	66823	1/2"	13-5/8"	20-5/8"	23/32"	11/16"	6"	1,500 lb	7,500 lb
	66824	1/2"	16-5/8"	26-5/8"	23/32"	11/16"	9"	1,500 lb	7,500 lb
	66825	1/2"	19-5/8"	32-5/8"	23/32"	11/16"	12"	1,500 lb	7,500 lb
	66826	5/8"	15-1/2"	22-3/4"	7/8"	29/32"	6"	2,250 lb	11,250 lb
	66827	5/8"	18-1/2"	28-3/4"	7/8"	29/32"	9"	2,250 lb	11,250 lb
	66828	5/8"	21-1/2"	34-3/4"	7/8"	29/32"	12"	2,250 lb	11,250 lb
	66829	3/4"	17-1/2"	25"	1"		6"	3,000 lb	15,000 lb
	66880	3/4"	20-1/2"	31"	1"		9"	3,000 lb	15,000 lb
	66881	3/4"	23-1/2"	31"	1"		12"	3,000 lb	15,000 lb



Eye & Eye Turnbuckles (Forged Steel)

Forged steel bodies & ends. Hot dipped galvanized finish. Features a lock nut on each end. Meets Spec. FF-T791b, Type 1, Form 1, Class 4.

	PART#	THREAD	OVERALL LENGTH CLOSED	OVERALL LENGTH OPEN	A, B	C	W.L.L.	U.L.L.
<input type="checkbox"/>	66830	1/4"	8-1/4"	12-1/4"	11/32"	4"	500 lb	2,500 lb
<input type="checkbox"/>	66831	5/16"	9-5/8"	14-1/8"	7/16"	4-1/2"	800 lb	4,000 lb
<input type="checkbox"/>	66832	3/8"	12-1/8"	18-1/8"	17/32"	6"	1,200 lb	6,000 lb
<input type="checkbox"/>	66833	1/2"	14"	21"	23/32"	6"	2,200 lb	11,000 lb

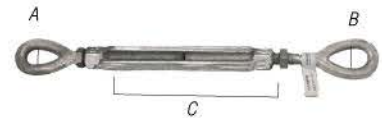

Jaw & Jaw Turnbuckles (Forged Steel)

Forged steel bodies & ends. Hot dipped galvanized finish. Features a lock nut on each end. Meets Spec. FF-T791b, Type 1, Form 1, Class 6.

	PART#	THREAD	OVERALL LENGTH CLOSED	OVERALL LENGTH OPEN	A, B	C	W.L.L.	U.L.L.
<input type="checkbox"/>	66840	1/4"	8"	12"	7/16"	4"	500 lb	2,500 lb
<input type="checkbox"/>	66841	5/16"	9-1/2"	14"	1/2"	4-1/2"	800 lb	4,000 lb
<input type="checkbox"/>	66842	3/8"	11-3/8"	17-3/8"	17/32"	6"	1,200 lb	6,000 lb
<input type="checkbox"/>	66843	1/2"	13"	20"	21/32"	6"	2,200 lb	11,000 lb
	66844	1/2"	16"	26"	21/32"	9"	2,200 lb	11,000 lb
	66845	1/2"	19"	32"	21/32"	12"	2,200 lb	11,000 lb
	66846	5/8"	14-7/8"	22-1/8"	25/32"	6"	3,500 lb	17,500 lb
	66847	5/8"	17-7/8"	28-1/8"	25/32"	9"	3,500 lb	17,500 lb
	66848	5/8"	20-7/8"	34-1/8"	25/32"	12"	3,500 lb	17,500 lb
	66849	3/4"	16-5/8"	24-1/8"	15/16"	6"	5,200 lb	26,000 lb
	66850	3/4"	19-5/8"	30-1/8"	15/16"	9"	5,200 lb	26,000 lb
	66851	3/4"	22-5/8"	36-1/8"	15/16"	12"	5,200 lb	26,000 lb



Sizes are approximate. Specifications subject to change without notice.





Stainless Steel Bolt Snaps

PART#	EYE INSIDE DIAMETER	GAP	OVERALL LENGTH	PACKAGE QUANTITY
64100	1/2"	9/32"	3-3/16"	5
64101	3/4"	11/32"	3-1/2"	5

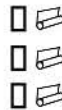

Stainless Steel Security Snaps

PART#	EYE INSIDE DIAMETER	GAP	OVERALL LENGTH	W.L.L.	PACKAGE QUANTITY
64102	5/8"	3/8"	3-3/8"	100 lb	5
64103	3/4"	1/2"	3-7/8"	200 lb	5
64104	7/8"	1/2"	4-5/8"	300 lb	5



Stainless Steel Spring Snaps

PART#	EYE INSIDE DIAMETER	OVERALL LENGTH	PACKAGE QUANTITY
64105	1/4"	1-7/8"	5
64106	3/8"	2-5/8"	5
64107	1/2"	3-7/8"	5



Stainless Steel Boat Snaps

PART#	EYE INSIDE DIAMETER	GAP	OVERALL LENGTH	PACKAGE QUANTITY
64108	1/2"	1/4"	2"	5
64109	5/8"	7/16"	2-3/4"	5
64110	3/4"	9/16"	3-1/4"	5
64111	3/4"	5/8"	3-7/8"	5



Aluminum Spring Snap

Zinc plated.

PART#	EYE INSIDE DIAMETER	GAP	OVERALL LENGTH	PACKAGE QUANTITY
64112	1/2"	1/4"	2-3/8"	5

66137



Safety Lanyard Snaps

PART#	TYPE	A	B	W.L.L.	U.L.L.
66137	Single latch	1-1/16"	3/4"	1,000 lb	5,000 lb
66137S	Double latch	1-1/16"	1"	1,000 lb	5,000 lb

66137S

Sizes are approximate. Specifications subject to change without notice.

Bull Snap

Zinc die cast and nickel plated.



PART#	EYE INSIDE DIAMETER	GAP	OVERALL LENGTH	PACKAGE QUANTITY
66330	1"	5/8"	4-1/8"	5



Solid Snap Hook

Forged steel.



PART#	EYE INSIDE DIAMETER	GAP	OVERALL LENGTH	PACKAGE QUANTITY
66331	11/16"	5/8"	3-1/2"	5



Cap Snap

Zinc plated.



PART#	EYE INSIDE DIAMETER	GAP	OVERALL LENGTH	PACKAGE QUANTITY
66332	1"	3/8"	3-5/8"	5



Swivel Eye Snaps

Zinc plated.

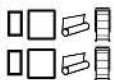

PART#	EYE INSIDE DIAMETER	GAP	OVERALL LENGTH	PACKAGE QUANTITY
66334	3/4"	7/16"	3-1/4"	5
66335	7/8"	7/16"	3-1/2"	5



Dog Lead Snap

Zinc plated.



PART#	EYE INSIDE DIAMETER	GAP	OVERALL LENGTH	PACKAGE QUANTITY
66336	3/8"	1/4"	2-1/2"	5



Sizes are approximate. Specifications subject to change without notice.





Trigger Snaps

Zinc plated.

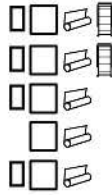

PART#	EYE INSIDE DIAMETER	GAP	OVERALL LENGTH	PACKAGE QUANTITY
66339	5/8"	1/2"	2-1/2"	5
66344	3/4"	1/2"	2-3/4"	5
66348	3/4"	3/8"	2-1/2"	5
66349	3/4"	1"	3-1/2"	5
66350	3/4"	3/4"	3-7/8"	5

Bolt Snaps

Zinc plated.

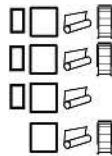

PART#	EYE INSIDE DIAMETER	GAP	OVERALL LENGTH	PACKAGE QUANTITY
66340	1/2"	11/16"	3-3/8"	5
66343	1/2"	3/4"	3-1/2"	5
66354	1/4"	7/16"	2-1/8"	5
66342	3/8"	7/16"	3-1/2"	5

Bolt Snaps

Solid Brass.



PART#	EYE INSIDE DIAMETER	GAP	OVERALL LENGTH	PACKAGE QUANTITY
66360	1/2"	9/16"	3"	5

Bolt Snaps

Brass.



PART#	EYE INSIDE DIAMETER	GAP	OVERALL LENGTH	PACKAGE QUANTITY
66361	1"	1/2"	3-1/2"	5

Bolt Snaps

Nickel Plated.



PART#	EYE INSIDE DIAMETER	GAP	OVERALL LENGTH	PACKAGE QUANTITY
66366	9/16"	3/4"	3-1/4"	5

Sizes are approximate. Specifications subject to change without notice.

Open Eye Snaps

Zinc Plated.



PART#	EYE INSIDE DIAMETER	GAP	OVERALL LENGTH	PACKAGE QUANTITY
66341	13/16"	1/2"	3-9/16"	5

Loop Snaps

Zinc Plated.



PART#	EYE INSIDE DIAMETER	GAP	OVERALL LENGTH	PACKAGE QUANTITY
66346	3/4"	1/2"	3-1/8"	5



66347	1"	1/2"	2-15/16"	5
--------------	----	------	----------	---

Swivel Loop Snaps

Nickel Plated.



PART#	EYE INSIDE DIAMETER	GAP	OVERALL LENGTH	PACKAGE QUANTITY
66352	3/4"	3/8"	3-1/4"	5



66353	1"	3/8"	3-1/4"	5
--------------	----	------	--------	---

Open Decoy Snaps

Zinc Die Cast.



PART#	EYE INSIDE DIAMETER	GAP	OVERALL LENGTH	PACKAGE QUANTITY
66355	1/2"	1/4"	2-1/2"	5

Spring Snap

Zinc Die Cast.



PART#	EYE INSIDE DIAMETER	GAP	OVERALL LENGTH	PACKAGE QUANTITY
66351	1"	7/16"	3-1/8"	5

Baby Square Eye Snaps



PART#	EYE INSIDE DIAMETER	GAP	OVERALL LENGTH	PACKAGE QUANTITY
66365	5/8"	1/4"	1-7/8"	5

Swivel Snaps

Zinc Plated.



PART#	EYE INSIDE DIAMETER	SNAP EYE	OVERALL LENGTH	PACKAGE QUANTITY
66367	1/2"	--	2"	5



66368	5/8"	--	2-7/16"	5
--------------	------	----	---------	---



66369	3/4"	--	2-5/8"	5
--------------	------	----	--------	---



66370	1"	--	3"	5
--------------	----	----	----	---



66371	3/8"	--	1-3/4"	5
--------------	------	----	--------	---

Nickel Plated.



66372	3/8"	11/16"	2-3/8"	5
--------------	------	--------	--------	---



General Hardware

Sizes are approximate. Specifications subject to change without notice.

Legend: 12x24 24x24 Plan-O-Gram Rack/End Cap Other

DYNALINE



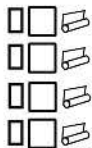

Lever Snaps

Nickel Plated.

PART#	EYE INSIDE DIAMETER	GAP	OVERALL LENGTH	PACKAGE QUANTITY
66374	5/8"	1/2"	3-1/4"	5
66375	3/4"	7/16"	3-1/2"	5
66376	1"	3/8"	3-1/2"	5
66377	1-1/8"	9/16"	4-7/16"	5



Security Snaps

PART#	EYE INSIDE DIAMETER	GAP	OVERALL LENGTH	PACKAGE QUANTITY
66380	7/8"	9/16"	3-7/8"	5
66381	1-1/8"	9/16"	5-1/8"	5



Swivel Security Snaps

PART#	EYE INSIDE DIAMETER	GAP	OVERALL LENGTH	PACKAGE QUANTITY
66394	1"	1"	4-1/8"	5



Panic Snap

Zinc plated.

PART#	EYE INSIDE DIAMETER	GAP	OVERALL LENGTH	PACKAGE QUANTITY
66338	1/2"	1"	4-1/16"	5



Eye Bull Snaps

Nickel Plated.

PART#	EYE INSIDE DIAMETER	GAP	OVERALL LENGTH	PACKAGE QUANTITY
66385	3/4"	9/16"	3-3/4"	5



Flat Spring Snap - Simplex

PART#	EYE INSIDE DIAMETER	GAP	OVERALL LENGTH	PACKAGE QUANTITY
66356	11/16"	5/16"	4-3/8"	5
66387	1/2"	1/4"	2-3/4"	5



Bronze Animal Snap

PART#	EYE INSIDE DIAMETER	GAP	OVERALL LENGTH	PACKAGE QUANTITY
66392	1"	9/16"	4-1/2"	5

Sizes are approximate. Specifications subject to change without notice.



Steel Snap Links

Formed steel with clear zinc plated finish.

	PART#	WIRE DIAMETER	GAP	LENGTH	W.L.L.	U.L.L.	PACKAGE QUANTITY
	66419	3/16"	1/4"	2"	220 lb	550 lb	10
	66420	1/4"	5/16"	2-3/8"	260 lb	650 lb	10
	66421	5/16"	3/8"	3-1/8"	500 lb	1,250 lb	10
	66422	3/8"	1/2"	4"	770 lb	1,925 lb	10
	66425	7/16"	5/8"	4-3/4"	900 lb	2,250 lb	5
	66426	1/2"	3/4"	5-3/8"	1,200 lb	3,000 lb	5



Aluminum Snap Links

For decorative and light applications. Multi-coloured.

	PART#	WIRE DIAMETER	GAP	LENGTH	PACKAGE QUANTITY
	66427	3/16"	1/2"	1-5/16"	10
	66428	1/4"	5/8"	2-7/16"	10
	66429	5/16"	7/8"	3-1/8"	10



Stainless Steel Snap Links

304 Stainless steel material.

	PART#	WIRE DIAMETER	GAP	LENGTH	W.L.L.	PACKAGE QUANTITY
	64070	3/16"	1/4"	1-15/16"	100 lb	5
	64071	1/4"	5/16"	2-3/8"	140 lb	5
	64072	5/16"	3/8"	3-1/8"	250 lb	5
	64073	3/8"	1/2"	4"	400 lb	5



Carabiner with Magnet

	PART#	BASE DIAMETER	GAP	BREAKAWAY CAPACITY	MATERIAL
	66700	1-1/4"	9/16"	75 lbs	Stainless Steel #304



Galvanized Dock Rope Cleat

PART#	DESCRIPTION	PACKAGE QUANTITY
12262	Galvanized steel material, 6"	5



Black Nylon Dock Rope Cleat

PART#	DESCRIPTION	PACKAGE QUANTITY
12264	Rugged black nylon construction, 4"	5



Sizes are approximate. Specifications subject to change without notice.





General Hardware

Square Keystock

Supplied in 12" lengths only. Carbon steel. Zinc plated finish. Thickness tolerance ± 0.1 mm; length tolerance ± 0.3 mm.



	PART#	WIDTH	HEIGHT	QTY.
ooo	22750	1/8"	1/8"	Pkg. of 5
ooo	22751	3/16"	3/16"	Pkg. of 5
ooo	22752	1/4"	1/4"	Pkg. of 5
ooo	22753	5/16"	5/16"	Pkg. of 5
ooo	22754	3/8"	3/8"	Pkg. of 5
ooo	22755	7/16"	7/16"	Pkg. of 5
ooo	22756	1/2"	1/2"	Pkg. of 5
ooo	22758	5/8"	5/8"	Pkg. of 2
	22760	3/4"	3/4"	Pkg. of 2
	22761	7/8"	7/8"	Pkg. of 1
	22763	1"	1"	Pkg. of 1

Rectangular Keystock

Supplied in 12" lengths only. Carbon steel. Zinc plated finish. Thickness tolerance ± 0.1 mm; length tolerance ± 0.1 mm.



	PART#	WIDTH	HEIGHT	QTY.
ooo	22782	1/4"	3/16"	Pkg. of 5
ooo	22785	1/4"	5/16"	Pkg. of 5
ooo	22786	1/4"	3/8"	Pkg. of 5
ooo	22789	5/16"	3/8"	Pkg. of 5
ooo	22791	3/8"	7/16"	Pkg. of 5
ooo	22792	3/8"	1/2"	Pkg. of 5
ooo	22795	7/16"	1/2"	Pkg. of 5
ooo	22796	1/2"	5/8"	Pkg. of 2

Step Keystock

Supplied in 12" lengths only. Carbon steel. Zinc plated finish. Thickness tolerance ± 0.1 mm; length tolerance ± 0.1 mm.

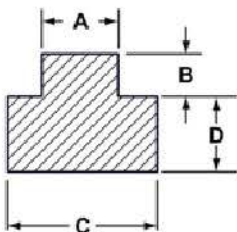

	PART#	A	B	C	D	QTY.
ooo	22821	3/16"	3/32"	1/4"	3/32"	Pkg. of 2
ooo	22822	1/4"	1/8"	5/16"	1/8"	Pkg. of 2
ooo	22823	1/4"	1/8"	3/8"	3/16"	Pkg. of 2
ooo	22824	5/16"	5/32"	3/8"	3/16"	Pkg. of 2
ooo	22825	3/8"	3/16"	7/16"	5/32"	Pkg. of 2
ooo	22826	3/8"	3/16"	1/2"	3/16"	Pkg. of 2
ooo	22827	7/16"	5/32"	1/2"	1/4"	Pkg. of 2
ooo	22828	1/2"	1/4"	5/8"	5/16"	Pkg. of 2

Sizes are approximate. Specifications subject to change without notice.

Clevis Pins

Yellow zinc dichromate finish. Hole is 1/4" from end of pin.
 Package quantity 10 pcs. Made of C1020 steel*.

PART#	PIN DIA.	HOLE DIA. (MM)	A	B	PART#	PIN DIA.	HOLE DIA. (MM)	A	B
22500	1/4"	2.6	1"	1-1/4"	22521	3/8"	3.8	1-3/4"	2"
22501	1/4"	2.6	1-1/4"	1-1/2"	22522	3/8"	3.8	2"	2-1/4"
22502	1/4"	2.6	1-1/2"	1-3/4"	22523	3/8"	3.8	2-1/4"	2-1/2"
22503	1/4"	2.6	1-3/4"	2"	22528	7/16"	3.8	1-1/4"	1-1/2"
22504	1/4"	2.6	2"	2-1/4"	22529	7/16"	3.8	1-1/2"	1-3/4"
22505	1/4"	2.6	2-1/4"	2-1/2"	22530	7/16"	3.8	1-3/4"	2"
22509	5/16"	3.5	1"	1-1/4"	22531	7/16"	3.8	2"	2-1/4"
22510	5/16"	3.5	1-1/4"	1-1/2"	22532	7/16"	3.8	2-1/4"	2-1/2"
22511	5/16"	3.5	1-1/2"	1-3/4"	22536	1/2"	3.8	1"	1-1/4"
22512	5/16"	3.5	1-3/4"	2"	22537	1/2"	3.8	1-1/4"	1-1/2"
22513	5/16"	3.5	2"	2-1/4"	22538	1/2"	3.8	1-1/2"	1-3/4"
22514	5/16"	3.5	2-1/4"	2-1/2"	22539	1/2"	3.8	1-3/4"	2"
22518	3/8"	3.8	1"	1-1/4"	22540	1/2"	3.8	2"	2-1/4"
22519	3/8"	3.8	1-1/4"	1-1/2"	22541	1/2"	3.8	2-1/4"	2-1/2"
22520	3/8"	3.8	1-1/2"	1-3/4"					

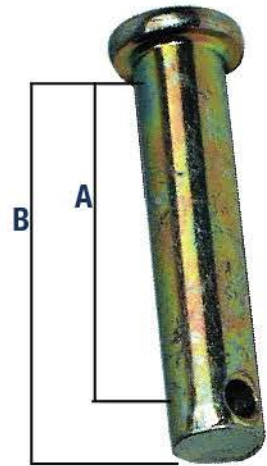

Clevis Pin Dynapaks

PART#	CONTENTS	QTY.	A	B	PART#	CONTENTS	QTY.	A	B
<input type="checkbox"/> 92500	22500	Pkg. of 5	1/4"	1"	92518	22518	Pkg. of 3	3-3/8"	1"
<input type="checkbox"/> 92502	22502	Pkg. of 5	1/4"	1-1/2"	92520	22520	Pkg. of 3	3-3/8"	1-1/2"
<input type="checkbox"/> 92504	22504	Pkg. of 5	5-1/4"	2"	92522	22522	Pkg. of 3	3-3/8"	2"
<input type="checkbox"/> 92509	22509	Pkg. of 5	5-5/16"	1"	92529	22529	Pkg. of 2	2-7/16"	1-1/2"
<input type="checkbox"/> 92511	22511	Pkg. of 5	5-5/16"	1-1/5"	92538	22538	Pkg. of 2	2-1/2"	1-1/2"
<input type="checkbox"/> 92513	22513	Pkg. of 5	5-5/16"	2"	92540	22540	Pkg. of 2	2-1/2"	2"



Adjustable Clevis Pins

A quick replacement pin, the universal clevis pin features a series of holes making it adaptable to varying lengths. Use the diameter that fits your application and cut off the excess length. Easily replaces bolts, cotter pins or rivets on all types of equipment. Yellow zinc dichromate finish. First pin hole is 1/4" from the end of the pin.

PART#	PIN DIAMETER	HOLE DIA. (MM)	OVERALL LENGTH	QTY.	PART#	PIN DIAMETER	HOLE DIA. (MM)	OVERALL LENGTH	QTY.
22545	1/4"	2.6	2"	Pkg. of 5	22551	1/2"	3.8	2-1/2"	Pkg. of 5
22546	5/16"	3.5	2"	Pkg. of 5	22552	7/16"	3.8	3"	Pkg. of 5
22547	3/8"	3.8	2"	Pkg. of 5	22553	1/2"	3.8	3"	Pkg. of 5
22548	7/16"	3.8	2"	Pkg. of 5	22554	5/8"	3.8	3"	Pkg. of 5
22549	1/2"	3.8	2"	Pkg. of 5	22555	3/4"	3.8	3"	Pkg. of 5
22550	7/16"	3.8	2-1/2"	Pkg. of 5					



* 1020 is a general purpose low tensile low hardenability carbon steel generally supplied in the cold drawn or turned and polished condition, with a typical tensile strength range 410 - 790 Mpa, and Brinell hardness range 119 - 235. Characterized by excellent weldability, very good machinability with reasonable strength and very good ductility.

Sizes are approximate. Specifications subject to change without notice.

Legend: 12x24 24x24 Plan-O-Gram Rack/End Cap Other



General Hardware



Machinery Bushings

Machinery bushings reduce wear between moving parts, prevent marring of fine finishes and can be used as spacers for sprockets, pulleys and gears on new or old equipment. Made of low carbon, mild steel with plain finish.

- 18 Gauge (l = light) = 0.042/0.054, 3/64"
- 14 Gauge (m = medium) = 0.068/0.082, 5/64"
- 10 Gauge (h = heavy) = 0.126/0.142, 1/8"
- Tolerances - O.D. +0.010/0.010 I.D. +0.010 / -0.000



Reference Chart Available

See end of catalogue

	PART#	IND#	INSIDE DIA.	OUTSIDE DIA.	GAUGE	QTY.
□	22700	M-16L	9/16"	1"	18	Pkg. of 10
□	22701	M-18L	5/8"	1-1/8"	18	Pkg. of 10
□	22702	M-18M	5/8"	1-1/8"	14	Pkg. of 10
□	22703	M-20L	3/4"	1-1/4"	18	Pkg. of 10
□	22704	M-20M	3/4"	1-1/4"	14	Pkg. of 10
□	22705	M-20H	3/4"	1-1/4"	10	Pkg. of 10
□	22706	M-22L	7/8"	1-3/8"	18	Pkg. of 10
□	22707	M-22M	7/8"	1-3/8"	14	Pkg. of 10
□	22708	M-24L	1"	1-1/2"	18	Pkg. of 10
□	22709	M-24M	1"	1-1/2"	14	Pkg. of 10
□	22710	M-24H	1"	1-1/2"	10	Pkg. of 10
□	22711	M-28L	1-1/8"	1-3/4"	18	Pkg. of 10
□	22712	M-28M	1-1/8"	1-3/4"	14	Pkg. of 10
□	22713	M-28H	1-1/8"	1-3/4"	10	Pkg. of 10
□	22714	M-30L	1-1/4"	1-7/8"	18	Pkg. of 10
□	22715	M-30M	1-1/4"	1-7/8"	14	Pkg. of 10
□	22716	M-30H	1-1/4"	1-7/8"	10	Pkg. of 10
□	22717	M-34L	1-3/8"	2-1/8"	18	Pkg. of 10
□	22718	M-34M	1-3/8"	2-1/8"	14	Pkg. of 10
□	22719	M-34H	1-3/8"	2-1/8"	10	Pkg. of 10
□	22720	M-36L	1-1/2"	2-1/4"	18	Pkg. of 10
□	22721	M-36M	1-1/2"	2-1/4"	14	Pkg. of 10
□	22722	M-36H	1-1/2"	2-1/4"	10	Pkg. of 10
□	22723	M-38M	1-5/8"	2-3/8"	14	Pkg. of 10
□	22724	M-38H	1-5/8"	2-3/8"	10	Pkg. of 10
□	22725	M-40M	1-3/4"	2-1/2"	14	Pkg. of 10
□	22726	M-40H	1-3/4"	2-1/2"	10	Pkg. of 10
□	22727	M-46M	1-7/8"	2-7/8"	14	Pkg. of 10
□	22728	M-46H	1-7/8"	2-7/8"	10	Pkg. of 10
□	22729	M-48M	2"	3"	14	Pkg. of 10
□	22730	M-48H	2"	3"	10	Pkg. of 10
□	22731	M-50M	2-1/8"	3-1/8"	14	Pkg. of 10
□	22732	M-50H	2-1/8"	3-1/8"	10	Pkg. of 10
□	22733	M-52M	2-1/4"	3-1/4"	14	Pkg. of 10
□	22734	M-52H	2-1/4"	3-1/4"	10	Pkg. of 10
□	22735	M-54M	2-3/8"	3-3/8"	14	Pkg. of 10
□	22736	M-54H	2-3/8"	3-3/8"	10	Pkg. of 10
□	22737	M-56M	2-1/2"	3-1/2"	14	Pkg. of 10
□	22738	M-56H	2-1/2"	3-1/2"	10	Pkg. of 10

Sizes are approximate. Specifications subject to change without notice.

Legend: □ 12x24 □ 24x24 □ Plan-O-Gram □ Rack/End Cap ○○○ Other



General Hardware



Packaged Extension Springs

ASTM A227, A228 or A764
 Carbon spring steel zinc plated finish.

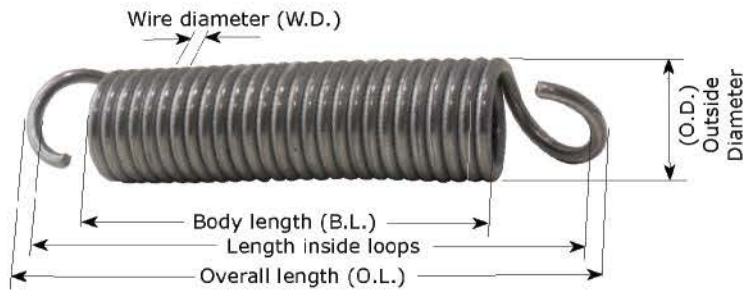

EXTENSION SPRING ENDS:

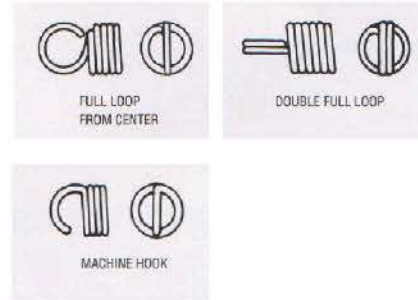

	PART#	REF#	WIRE DIA.	OUTSIDE DIA.	OVERALL LENGTH	BODY LENGTH	MAXIMUM STRETCH	LOAD RATE (LB/IN)	MAX LOAD (LB)	END TYPE	TYPE LOOP	PKG. QTY.
<input type="checkbox"/>	24001	C-1	0.015"	0.125"	1.5"	1.25"	2"	0.65	1.4	loop	B	2
<input type="checkbox"/>	24005	C-5	0.02"	0.156"	1.5"	1.188"	1.7"	1.50	2.7	loop	B	2
<input type="checkbox"/>	24013	C-13	0.023"	0.218"	1.5"	1.064"	2.4"	1.10	2.9	loop	B	2
<input type="checkbox"/>	24019	C-19	0.035"	0.25"	1.5"	1"	1.1"	6.40	8.4	loop	B	2
<input type="checkbox"/>	24023	C-23	0.025"	0.281"	1.5"	0.938"	3.4"	0.74	2.8	loop	B	2
<input type="checkbox"/>	24025	C-25	0.02"	0.312"	1.5"	0.876"	7.7"	0.17	1.4	loop	B	2
<input type="checkbox"/>	24029	C-29	0.028"	0.343"	1.5"	0.814"	3.2"	0.81	3.6	loop	B	2
<input type="checkbox"/>	24031	C-31	0.028"	0.437"	1.5"	0.626"	4.4"	0.54	2.5	loop	B	2
<input type="checkbox"/>	24033	C-33	0.047"	0.437"	1.5"	0.626"	1.6"	6.20	11	loop	B	2
<input type="checkbox"/>	24051	C-51	0.014"	0.125"	1.875"	1.625"	3.3"	0.35	1.3	loop	B	2
<input type="checkbox"/>	24055	C-55	0.02"	0.156"	1.875"	1.563"	2.7"	1.10	2.2	loop	B	2
<input type="checkbox"/>	24063	C-63	0.023"	0.218"	1.875"	1.439"	3.4"	0.79	2.9	loop	B	2
<input type="checkbox"/>	24067	C-67	0.02"	0.25"	1.875"	1.375"	6.4"	0.25	1.7	loop	B	2
<input type="checkbox"/>	24069	C-69	0.035"	0.25"	1.875"	1.375"	1.5"	4.70	8.4	loop	B	2
<input type="checkbox"/>	24073	C-73	0.025"	0.281"	1.875"	1.313"	2.8"	0.54	4.7	loop	B	2
<input type="checkbox"/>	24077	C-77	0.025"	0.344"	1.875"	1.189"	6.8"	0.31	2.3	loop	B	2
<input type="checkbox"/>	24081	C-81	0.028"	0.437"	1.875"	1"	7.8"	0.30	2.5	loop	B	2
<input type="checkbox"/>	24083	C-83	0.047"	0.437"	1.875"	1"	2.3"	4.30	11	loop	B	2
<input type="checkbox"/>	24103	C-103	0.018"	0.125"	2.5"	2.25"	2.2"	0.96	2.5	loop	B	2
<input type="checkbox"/>	24105	C-105	0.02"	0.156"	2.5"	2.188"	3"	0.81	2.7	loop	B	2
<input type="checkbox"/>	24111	C-111	0.025"	0.187"	2.5"	2.126"	2.5"	1.50	4.2	loop	B	2
<input type="checkbox"/>	24115	C-115	0.016"	0.25"	2.5"	2"	15"	0.50	0.87	loop	B	2
<input type="checkbox"/>	24117	C-117	0.02"	0.25"	2.5"	2"	9"	0.17	1.7	loop	B	2
<input type="checkbox"/>	24119	C-119	0.035"	0.25"	2.5"	2"	2.1"	3.50	8.4	loop	B	2
<input type="checkbox"/>	24131	C-131	0.028"	0.437"	2.5"	1.626"	13"	0.18	2.5	loop	B	2
<input type="checkbox"/>	24133	C-133	0.047"	0.437"	2.5"	1.665"	3.4"	3.00	11	loop	B	2
<input type="checkbox"/>	24135	C-135	0.062"	0.437"	2"	1.126"	0.87"	17.00	19	loop	B	2
<input type="checkbox"/>	24139	C-139	0.054"	0.437"	3.5"	2.626"	2.5"	4.00	12	loop	B	2
<input type="checkbox"/>	24141	C-141	0.072"	0.625"	2.5"	1.375"	1.5"	10.00	19	loop	B	2

continued on next page

Sizes are approximate. Specifications subject to change without notice.



Packaged Extension Springs Continued

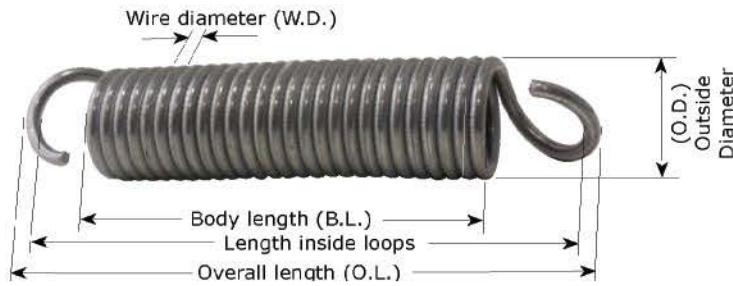

EXTENSION SPRING ENDS:

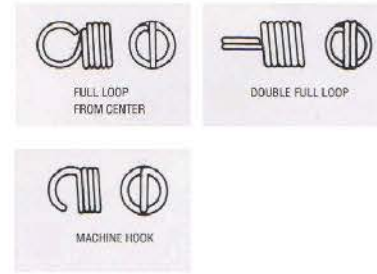

	PART#	REF#	WIRE DIA.	OUTSIDE DIA.	OVERALL LENGTH	BODY LENGTH	MAXIMUM STRETCH	LOAD RATE (LB/IN)	MAX LOAD (LB)	END TYPE	PKG. QTY.
<input type="checkbox"/>	24143	C-143	0.054"	0.562"	3"	1.875"	3.4"	2.30	9.2	loop	2
<input type="checkbox"/>	24155	C-155	0.028"	0.312"	3"	2.375"	7.8"	0.41	3.5	loop	2
<input type="checkbox"/>	24157	C-157	0.025"	0.25"	3.25"	2.75"	6.4"	0.44	3.1	loop	2
<input type="checkbox"/>	24161	C-161	0.034"	0.437"	2.75"	1.875"	5.9"	5.00	3.3	loop	2
<input type="checkbox"/>	24163	C-163	0.047"	0.437"	3.5"	2.626"	3.6"	2.00	8.4	loop	2
<input type="checkbox"/>	24165	C-165	0.08"	0.5"	1.625"	0.625"	2"	66.00	35	loop	2
<input type="checkbox"/>	24171	C-171	0.105"	0.75"	2"	0.5"	2.59"	92.00	60	hook	2
<input type="checkbox"/>	24173	C-173	0.105"	0.75"	2.25"	0.75"	3"	68.00	60	hook	2
<input type="checkbox"/>	24175	C-175	0.105"	0.75"	2.437"	0.9375"	3.3"	47.00	50	hook	2
<input type="checkbox"/>	24177	C-177	0.105"	0.75"	2.625"	1.125"	3.625"	38.00	50	hook	2
<input type="checkbox"/>	24179	C-179	0.072"	0.562"	2.875"	1.75"	4.475"	11.00	22	loop	2
<input type="checkbox"/>	24181	C-181	0.072"	0.625"	3.25"	2"	5.6"	6.40	19	loop	2
<input type="checkbox"/>	24183	C-183	0.047"	0.562"	4"	2.91"	11.6"	0.76	6.5	loop	2
<input type="checkbox"/>	24185	C-185	0.062"	0.75"	3.5"	2"	9"	1.70	11	loop	2
<input type="checkbox"/>	24187	C-187	0.105"	0.75"	2.875"	1.375"	N/A	39.00	60	hook	2
<input type="checkbox"/>	24189	C-189	0.105"	0.75"	3.125"	1.625"	4.3"	33.00	50	hook	2
<input type="checkbox"/>	24191	C-191	0.105"	0.75"	3.75"	2.25"	6"	26.00	50	hook	2
<input type="checkbox"/>	24193	C-193	0.034"	0.375"	4"	3.25"	11.3"	0.47	3.9	loop	2
<input type="checkbox"/>	24205	C-205	0.034"	0.25"	5"	4.5"	8.5"	1.40	6	loop	2
<input type="checkbox"/>	24209	C-209	0.028"	0.375"	4.5"	3.75"	18"	0.15	2.9	loop	2
<input type="checkbox"/>	24215	C-215	0.041"	0.375"	3.75"	3"	7.5"	1.40	6.5	loop	2
<input type="checkbox"/>	24219	C-219	0.041"	0.468"	4.5"	3.564"	13"	0.54	5.2	loop	2
<input type="checkbox"/>	24221	C-221	0.062"	0.5"	4.5"	3.5"	7.7"	4.10	16	loop	2
<input type="checkbox"/>	24223	C-223	0.072"	0.5"	5"	4"	7.3"	8.20	25	loop	2
<input type="checkbox"/>	24227	C-227	0.091"	0.687"	4.75"	3.875"	7.25"	11.00	35	hook	2
<input type="checkbox"/>	24231	C-231	0.072"	0.562"	6"	4.876"	9.8"	4.60	22	loop	2
<input type="checkbox"/>	24233	C-233	0.034"	0.25"	6"	5.5"	10.3"	1.10	6	loop	2
<input type="checkbox"/>	24235	C-235	0.028"	0.312"	6"	5.375"	21"	0.23	3.9	loop	2
<input type="checkbox"/>	24239	C-239	0.047"	0.375"	6.5"	5.75"	11.5"	1.60	10	loop	2
<input type="checkbox"/>	24243	C-243	0.054"	0.625"	6.5"	5.25"	17.5"	0.65	8.3	loop	2
<input type="checkbox"/>	24251	C-251	0.105"	1.125"	16"	13.75"	38"	1.20	31	hook	1
<input type="checkbox"/>	24253	C-253	0.054"	0.562"	16.5"	15.375"	41.5"	0.32	9.2	double loop closed	1

continued on next page

Sizes are approximate. Specifications subject to change without notice.



Packaged Extension Springs Continued

	PART#	REF#	WIRE DIA.	OUTSIDE DIA.	OVERALL LENGTH	BODY LENGTH	MAXIMUM STRETCH	LOAD RATE (LB/IN)	MAX LOAD (LB)	END TYPE	PKG. QTY.
<input type="checkbox"/>	24257	C-257	0.091"	0.812"	4.5"	3.375"	7.8"	7.10	29	hook	2
<input type="checkbox"/>	24259	C-259	0.12"	0.812"	4"	2.375"	1.3"	39.00	66	hook	2
<input type="checkbox"/>	24261	C-261	0.12"	1.062"	5.5"	3.375"	9.7"	9.50	49	hook	1
<input type="checkbox"/>	24263	C-263	0.091"	0.875"	6"	4.875"	11.6"	3.90	26	hook	1
<input type="checkbox"/>	24265	C-265	0.105"	1.062"	7"	4.875"	14.5"	3.7	33	hook	1
<input type="checkbox"/>	24267	C-267	0.162"	1.25"	6.5"	4"	9.5"	26	100	hook	1
<input type="checkbox"/>	24269	C-269	0.135"	1"	7"	5"	10"	18	75	double loop closed	1
<input type="checkbox"/>	24271	C-271	0.08"	1.062"	8.5"	6.375"	27.5"	0.69	15	hook	1
<input type="checkbox"/>	24273	C-273	0.148"	1.125"	8.5"	6.25"	12.9"	15	87	hook	1
<input type="checkbox"/>	24275	C-275	0.091"	1.125"	7.5"	6.312"	20.5"	1.3	20	hook	1
<input type="checkbox"/>	24277	C-277	0.091"	0.65"	6.5"	5.5"	10.5"	5.9	31	hook	1
<input type="checkbox"/>	24281	C-281	0.062"	0.375"	5.5"	5"	7.4"	8.9	23	loop	2
<input type="checkbox"/>	24285	C-285	0.035"	0.375"	5"	4.25"	16"	0.43	5.4	loop	2
<input type="checkbox"/>	24287	C-287	0.032"	0.312"	5"	4.375"	14.8"	0.48	5.2	loop	2
<input type="checkbox"/>	24289	C-289	0.035"	0.312"	5"	4.375"	12.4"	0.79	6.6	loop	2
<input type="checkbox"/>	24293	C-293	0.062"	0.375"	6.75"	6"	2.5"	6.8	23	loop	1
<input type="checkbox"/>	24301	C-301	0.135"	1.5"	11.5"	8.5"	26.5"	2.7	47	double loop closed	1
<input type="checkbox"/>	24303	C-303	0.105"	1"	12"	10"	24"	2.4	35	hook	1
<input type="checkbox"/>	24307	C-307	0.135"	1.062"	12"	9.875"	19"	7.7	69	hook	1
<input type="checkbox"/>	24311	C-311	0.041"	0.437"	10.25"	9.375"	27"	0.28	5.5	loop	1
<input type="checkbox"/>	24313	C-313	0.047"	0.5"	8.5"	7.5"	22.5"	0.46	7.2	loop	1
<input type="checkbox"/>	24315	C-315	0.047"	0.437"	8.5"	7.626"	18"	0.73	8.4	loop	1
<input type="checkbox"/>	24317	C-317	0.091"	0.625"	8.5"	7.25"	12.3"	7.7	39	loop	1
<input type="checkbox"/>	24319	C-319	0.054"	0.562"	8.5"	7.376"	20"	0.64	9.2	loop	1
<input type="checkbox"/>	24321	C-321	0.062"	0.625"	8.5"	7.75"	19.5"	0.95	13	loop	1
<input type="checkbox"/>	24323	C-323	0.08"	0.625"	8.5"	7.25"	14"	3.9	27	loop	1
<input type="checkbox"/>	24325	C-325	0.062"	0.875"	8.5"	6.75"	32"	0.33	8.8	hook	1
<input type="checkbox"/>	24329	C-329	0.105"	0.875"	8.5"	6.75"	14"	5.4	41	hook	1
<input type="checkbox"/>	24333	C-333	0.135"	0.875"	9"	7.25"	12"	20	87	hook	1
<input type="checkbox"/>	24337	C-337	0.12"	1"	8.5"	6.5"	13"	7.7	52	hook	1
<input type="checkbox"/>	24339	C-339	0.148"	1.25"	10"	7.5"	16.5"	9.2	77	hook	1

Drawbar Spring

ASTM A227, A228 or A764 - Carbon spring steel zinc plated finish

	PART#	REF#	WIRE DIAMETER	OUTSIDE DIAMETER	OVERALL LENGTH	LOAD RATE (LB/IN)	MAXIMUM LOAD (LB)
<input type="checkbox"/>	24900	4001	0.227"	1-9/16"	7-1/4"	152.78	330.31



Sizes are approximate. Specifications subject to change without notice.

Legend: 12x24 24x24 Plan-O-Gram Rack/End Cap Other

DYNALINE



General Hardware



Packaged Compression Springs

S.A.E. 1060-1090 spring steel. Phosphate and oil finish.
Retail package with UPC barcode label.

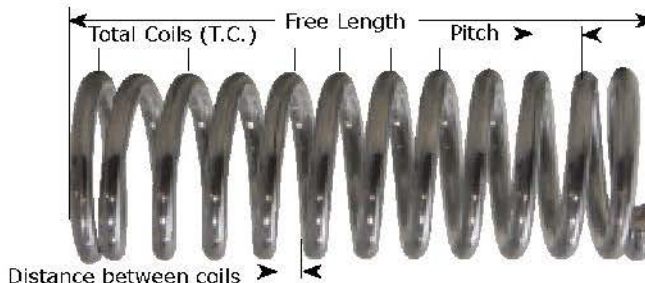
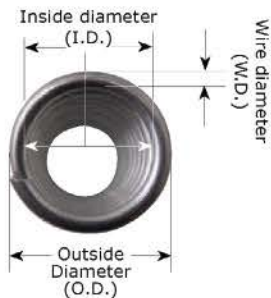

General Hardware



	PART#	REF#	WIRE DIA.	OUTSIDE DIA.	OVERALL LENGTH	SOLID HEIGHT	TOTAL COILS	LOAD RATE (LB/IN)	MAX LOAD (LB)	PKG. QTY.
<input type="checkbox"/>	24500	C-500	0.023"	0.156"	0.562"	0.28	11	19.00	4.5	6
<input type="checkbox"/>	24510	C-510	0.035"	0.25"	0.5"	0.26	7	42.00	6.2	6
<input type="checkbox"/>	24516	C-516	0.011"	0.156"	1"	0.14	12	0.73	0.57	6
<input type="checkbox"/>	24520	C-520	0.016"	0.187"	0.875"	0.27	16	1.30	0.81	6
<input type="checkbox"/>	24526	C-526	0.028"	0.187"	1"	0.48	17	15.00	6.3	6
<input type="checkbox"/>	24530	C-530	0.02"	0.218"	1"	0.24	11	3.30	2.2	6
<input type="checkbox"/>	24532	C-532	0.013"	0.187"	1"	0.14	10	0.99	0.78	6
<input type="checkbox"/>	24550	C-550	0.016"	0.187"	1"	0.2	12	2.00	1.3	6
<input type="checkbox"/>	24554	C-554	0.02"	0.25"	1"	0.2	9	2.80	1.9	6
<input type="checkbox"/>	24556	C-556	0.026"	0.312"	0.625"	0.18	7	7.00	3.1	6
<input type="checkbox"/>	24562	C-562	0.035"	0.25"	1"	0.46	12	21.00	8.9	6
<input type="checkbox"/>	24566	C-566	0.032"	0.375"	0.75"	0.22	6	7.70	3.2	6
<input type="checkbox"/>	24570	C-570	0.014"	0.125"	1.375"	0.34	27	1.60	1.4	6
<input type="checkbox"/>	24576	C-576	0.016"	0.156"	1.375"	0.35	21	1.80	1.6	6
<input type="checkbox"/>	24578	C-578	0.013"	0.187"	1.375"	0.18	12	0.71	0.78	6
<input type="checkbox"/>	24580	C-580	0.028"	0.187"	1.375"	0.65	23	11.00	6.3	6
<input type="checkbox"/>	24582	C-582	0.016"	0.187"	1.375"	0.26	15	1.40	1.3	6
<input type="checkbox"/>	24600	C-600	0.02"	0.218"	1.375"	0.31	15	2.40	2.2	4
<input type="checkbox"/>	24604	C-604	0.023"	0.218"	1.375"	0.39	16	3.90	3.3	4
<input type="checkbox"/>	24608	C-608	0.02"	0.25"	1.375"	0.25	12	2.00	1.9	4
<input type="checkbox"/>	24612	C-612	0.028"	0.281"	1.375"	0.43	15	4.40	4.1	4
<input type="checkbox"/>	24614	C-614	0.041"	0.312"	1.25"	0.62	15	17.00	8.3	4
<input type="checkbox"/>	24624	C-624	0.041"	0.375"	1.125"	0.46	10	13.00	7	4
<input type="checkbox"/>	24632	C-632	0.041"	0.437"	1.062"	0.36	8	11.00	6.1	4
<input type="checkbox"/>	24650	C-650	0.013"	0.218"	1.75"	0.247	18	0.29	0.44	4
<input type="checkbox"/>	24652	C-652	0.028"	0.218"	1.375"	0.53	18	8.10	5.5	4
<input type="checkbox"/>	24660	C-660	0.016"	0.312"	1.75"	0.2	12	0.39	0.61	4
<input type="checkbox"/>	24664	C-664	0.047"	0.343"	1.5"	0.71	15	23.00	11	4
<input type="checkbox"/>	24668	C-668	0.026"	0.375"	1.5"	0.26	10	1.70	2.2	4
<input type="checkbox"/>	24672	C-672	0.035"	0.375"	1.75"	0.54	16	3.70	4.2	4
<input type="checkbox"/>	24676	C-676	0.032"	0.437"	2.125"	0.39	12	2.00	2.8	4
<input type="checkbox"/>	24680	C-680	0.047"	0.312"	2"	1.14	24	18.00	12	4

Sizes are approximate. Specifications subject to change without notice.



Packaged Compression Springs Continued

PART#	REF#	WIRE DIA.	OUTSIDE DIA.	OVERALL LENGTH	SOLID HEIGHT	TOTAL COILS	LOAD RATE (LB/IN)	MAX LOAD (LB)	PKG. QTY.
<input type="checkbox"/> 24690	C-690	0.041"	0.437"	2.25"	0.67	16	4.90	6.1	2
<input type="checkbox"/> 24692	C-692	0.041"	0.625"	1.5"	0.37	9	3.40	3.8	2
<input type="checkbox"/> 24700	C-700	0.062"	0.5"	1"	0.54	8	45.00	17	2
<input type="checkbox"/> 24702	C-702	0.054"	0.562"	1"	0.38	7	16	9.5	2
<input type="checkbox"/> 24704	C-704	0.041"	0.5"	1.5"	0.45	10	5.30	5.4	2
<input type="checkbox"/> 24706	C-706	0.072"	0.562"	1.375"	0.74	10	45	22	2
<input type="checkbox"/> 24712	C-712	0.091"	0.687"	1.25"	0.75	8	89	35	2
<input type="checkbox"/> 24714	C-714	0.062"	0.375"	2.25"	1.46	22	34	22	2
<input type="checkbox"/> 24720	C-720	0.062"	0.5"	1.75"	0.85	14	24	17	2
<input type="checkbox"/> 24722	C-722	0.047"	0.5"	2"	0.635	13	7.19	N/A	2
<input type="checkbox"/> 24724	C-724	0.054"	0.437"	2"	0.89	16	16	13	2
<input type="checkbox"/> 24730	C-730	0.047"	0.406"	2.75"	1.12	23	7.30	9.7	2
<input type="checkbox"/> 24736	C-736	0.072"	0.5"	2.75"	1.48	19	28	25	2
<input type="checkbox"/> 24740	C-740	0.08"	0.625"	2.5"	1.14	14	32	27	2
<input type="checkbox"/> 24742	C-742	0.054"	0.625"	2.75"	0.77	14	5.80	9.1	2
<input type="checkbox"/> 24750	C-750	0.08"	0.75"	2"	0.78	10	25	23	2
<input type="checkbox"/> 24752	C-752	0.08"	0.937"	2"	0.67	8	17	19	2
<input type="checkbox"/> 24756	C-756	0.041"	0.718"	3.5"	0.47	11	1.50	3.8	2
<input type="checkbox"/> 24766	C-766	0.054"	0.562"	3"	0.96	17	6.30	10	2
<input type="checkbox"/> 24768	C-768	0.105"	0.812"	2.25"	1.26	11	54.94	N/A	2
<input type="checkbox"/> 24782	C-782	0.08"	0.625"	3"	1.34	16	26	27	2
<input type="checkbox"/> 24792	C-792	0.105"	0.875"	3"	1.39	14	34	43	2
<input type="checkbox"/> 24802	C-802	0.148"	1.375"	4.375"	1.83	13	36	72	1
<input type="checkbox"/> 24806	C-806	0.148"	1.5"	3.25"	1.26	9	43	67	1
<input type="checkbox"/> 24814	C-814	0.135"	1.375"	2.5"	0.98	8	48	55	1
<input type="checkbox"/> 24818	C-818	0.12"	1.125"	4"	1.72	13	26	48	2
<input type="checkbox"/> 24822	C-822	0.148"	0.937"	4"	2.63	12	89	103	2
<input type="checkbox"/> 24826	C-826	0.12"	1"	3.5"	1.71	15	36	54	2
<input type="checkbox"/> 24830	C-830	0.12"	1.125"	3"	1	10	22	34	2
<input type="checkbox"/> 24832	C-832	0.12"	1"	3"	1.41	12	45	54	2
<input type="checkbox"/> 24834	C-834	0.12"	1.187"	2.75"	1.2	9	35	46	2
<input type="checkbox"/> 24836	C-836	0.08"	0.875"	4"	1.28	15	9	20	2
<input type="checkbox"/> 24838	C-838	0.08"	0.75"	3.5"	1.38	16	14	23	2
<input type="checkbox"/> 24850	C-850	0.091"	0.625"	5"	2.64	29	29	38	2
<input type="checkbox"/> 24856	C-856	0.091"	0.75"	6"	2.78	30	13	32	2
<input type="checkbox"/> 24858	C-858	0.072"	0.687"	6"	2.16	29	6.20	18	2
<input type="checkbox"/> 24864	C-864	0.091"	0.875"	6"	2.18	23	9.30	28	1
<input type="checkbox"/> 24874	C-874	0.12"	1.375"	6"	1.08	14	13	40	1
<input type="checkbox"/> 24878	C-878	0.08"	0.625"	9"	3.72	45	8.40	27	1
<input type="checkbox"/> 24892	C-892	0.162"	1.125"	7"	4	24	49	111	1



General Hardware

Sizes are approximate. Specifications subject to change without notice.

Legend: 12x24 24x24 Plan-O-Gram Rack/End Cap Other



What are retaining rings?

Retaining Rings are precision engineered components that are designed to be applied on shafts or in bores and provide a shoulder that accurately positions, locates and retains other parts of an assembly. Many different types of retaining rings have been developed over the years, each a solution to a specific problem. Different types of rings are available to solve issues such as: tolerance take-up, clearance diameter, thrust load capacity, flexible installation, rpm capacity, impact loading, non-removable lock-rings, groove-less push-on fastening and radial installation.

As an engineering concept, the retaining ring is still relatively young and has certainly not yet reached its peak of utilization as a retaining device.

How are retaining rings used?

Retaining Rings work by creating a shoulder that can hold components in place. The retaining shoulder is created when the ring attaches itself to the bore or shaft, typically by snapping into a groove.

Ordinarily (however not always) a groove is dug into the shaft or bore, and this groove becomes the seat for the retaining ring.

Retaining rings are designed such that their contact diameter has some interference fit with the groove in which they fit. This creates a "snug" fit between the ring and groove. The term used to describe the amount of interference fit is "cling".

Cling causes the retaining ring to fit tightly and securely against its groove bottom. Without cling a ring would have a loose fit and would "rattle" in its groove. This lack of cling would decrease the retention capacity of the ring because a "cling-less" ring is free to move radially, creating weak retention points that will ultimately cause the assembly to fail.

Another key factor is the width of the groove. The groove width is slightly larger than the rings thickness, thus creating a snug axial fit. The tight axial fit along with the cling to the groove bottom create a rigid shoulder which can retain thrust loads.

E Retainer Rings

The universally used radially assembled circlip for shafts. The groove is gripped by 3 tabs. Applications in vehicle construction, optical and electronic industry, and light mechanical industry. Cross reference to 1000, 1500, 5133,ms-16633 series. S.A.E. 1060-1090 Spring steel. Phosphate & oil finish. 10 pieces per pkg.



Reference Chart Available

See end of catalogue

PART#	IND#	SHAFT DECIMAL	SHAFT FRACTION	RING OUTSIDE DIA.	RING THICKNESS	GROOVE DIA.	GROOVE DEPTH	GROOVE WIDTH	WEIGHT (LB) /100 PIECES
 22860	12	0.125	1/8"	0.23	0.015	0.10	0.02	0.02	0.0087
 22861	18	0.188	3/16"	0.335	0.025	0.15	0.02	0.029	0.029
 22862	25	0.25	1/4"	0.527	0.025	0.21	0.02	0.029	0.076
 22863	31	0.312	5/16"	0.5	0.025	0.25	0.03	0.029	0.057
 22864	37	0.375	3/8"	0.66	0.035	0.30	0.04	0.039	0.15
 22865	43	0.438	7/16"	0.687	0.035	0.34	0.05	0.039	0.15
 22866	50	0.5	1/2"	0.8	0.042	0.40	0.05	0.046	0.25
 22867	62	0.625	5/8"	0.94	0.042	0.49	0.07	0.046	0.32
 22868	75	0.75	3/4"	1.12	0.05	0.58	0.09	0.056	0.58
 22869	87	0.875	7/8"	1.3	0.05	0.68	0.10	0.056	0.76
 22870	98	0.984	1"	1.5	0.05	0.84	0.08	0.056	0.92
 22871	118	1.188	1-3/16"	1.626	0.062	1.08	0.05	0.068	1.13
 22872	137	1.375	1-3/8"	1.875	0.062	1.23	0.07	0.068	1.54

Sizes are approximate. Specifications subject to change without notice.



General Hardware



Internal Retainer Rings

The universally applicable rings for shafts and bores. Applications in all branches of industry and machine, instrument and vehicle construction. Cross reference to 1300, 3000, 5000, HO, MS-16625 series. S.A.E. 1060-1090 Spring steel. Phosphate and oil finish.

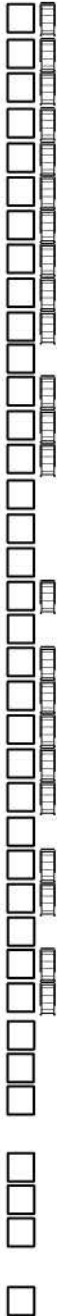

PART#	IND#	BORE DECIMAL	BORE FRACTION	RING OUTSIDE DIAMETER	RING THICKNESS	GROOVE DIAMETER	GROOVE DEPTH	GROOVE WIDTH	PKG. QTY.
22873	25	0.25	1/4"	0.28	0.015	0.27	0.01	0.02	10
22874	31	0.312	5/16"	0.346	0.015	0.33	0.01	0.02	10
22875	37	0.375	3/8"	0.415	0.025	0.40	0.01	0.029	10
22876	43	0.438	7/16"	0.482	0.025	0.46	0.01	0.029	10
22878	50	0.5	1/2"	0.548	0.035	0.53	0.02	0.039	10
22879	56	0.562	9/16"	0.62	0.035	0.60	0.02	0.039	10
22880	62	0.625	5/8"	0.694	0.035	0.67	0.02	0.039	10
22881	68	0.688	11/16"	0.763	0.035	0.73	0.02	0.039	10
22882	75	0.75	3/4"	0.831	0.035	0.80	0.02	0.039	10
22884	87	0.875	7/8"	0.971	0.042	0.93	0.03	0.046	10
22885	93	0.938	15/16"	1.041	0.042	1.00	0.03	0.046	10
22886	100	1	1"	1.111	0.042	1.07	0.03	0.046	10
22888	106	1.062	1-1/16"	1.18	0.05	1.13	0.03	0.056	10
22889	112	1.125	1-1/8"	1.249	0.05	1.20	0.04	0.056	10
22890	118	1.188	1-3/16"	1.319	0.05	1.26	0.04	0.056	10
22891	125	1.25	1-1/4"	1.388	0.05	1.33	0.04	0.056	10
22892	131	1.312	1-5/16"	1.456	0.05	1.40	0.04	0.056	10
22893	137	1.375	1-3/8"	1.526	0.05	1.46	0.04	0.056	10
22894	143	1.438	1-7/16"	1.596	0.05	1.53	0.05	0.056	10
22895	150	1.5	1-1/2"	1.66	0.05	1.59	0.05	0.056	10
22896	156	1.562	1-9/16"	1.734	0.062	1.66	0.05	0.068	10
22897	162	1.625	1-5/8"	1.804	0.062	1.73	0.05	0.068	10
22900	175	1.75	1-3/4"	1.942	0.062	1.86	0.05	0.068	10
22901	181	1.812	1-13/16"	2.012	0.062	1.92	0.06	0.068	10
22902	187	1.875	1-7/8"	2.072	0.062	1.99	0.06	0.068	10
22903	193	1.938	1-15/16"	2.141	0.062	2.06	0.06	0.068	10
22904	200	2	2"	2.21	0.062	2.12	0.06	0.068	10
22905	206	2.062	2-1/16"	2.28	0.078	2.19	0.06	0.086	5
22906	212	2.125	2-1/8"	2.35	0.078	2.25	0.06	0.086	5
22907	225	2.25	2-1/4"	2.49	0.078	2.38	0.07	0.086	5
22908	237	2.375	2-3/8"	2.63	0.078	2.52	0.07	0.086	5
22909	244	2.44	2-7/16"	2.702	0.078	2.58	0.07	0.086	5
22910	250	2.5	2-1/2"	2.775	0.078	2.65	0.07	0.086	5
22911	262	2.625	2-5/8"	2.91	0.093	2.78	0.08	0.103	5
22912	268	2.688	2-11/16"	2.98	0.093	2.85	0.08	0.103	5
22913	275	2.75	2-3/4"	3.05	0.093	2.91	0.08	0.103	5
22914	281	2.812	2-13/16"	3.121	0.093	2.98	0.08	0.103	5
22915	287	2.875	2-7/8"	3.191	0.093	3.05	0.09	0.103	2
22916	300	3	3"	3.325	0.093	3.18	0.09	0.103	2
22917	325	3.25	3-1/4"	3.623	0.109	3.45	0.10	0.12	2
22918	350	3.5	3-1/2"	3.89	0.109	3.71	0.11	0.12	2
22919	400	4	4"	4.424	0.109	4.24	0.12	0.12	2
22920	450	4.5	4-1/2"	4.94	0.109	4.74	0.12	0.12	2
22921	500	5	5"	5.485	0.109	5.26	0.13	0.12	2
22922	550	5.5	5-1/2"	6.066	0.125	5.77	0.14	0.139	2
22923	600	6	6"	6.62	0.125	6.27	0.14	0.139	2

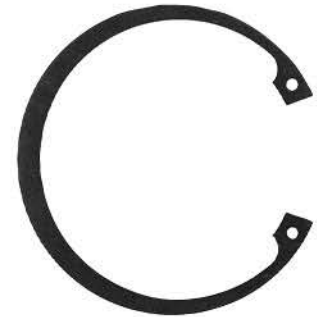

Reference Chart Available
See end of catalogue

Sizes are approximate. Specifications subject to change without notice.



External Retainer Rings (Basic)

The universally applicable rings for shafts and bores. Applications in all branches of industry and machine, instrument and vehicle construction. Cross reference to 1300, 3000, 5000, HO, MS-16625 series. S.A.E. 1060-1090 spring steel. Phosphate and oil finish.

PART#	IND#	SHAFT DECIMAL	SHAFT FRACTION	RING OUTSIDE DIAMETER	RING THICKNESS	GROOVE DIAMETER	GROOVE DEPTH	GROOVE WIDTH	PKG. QTY.
22924	18	0.188	3/16"	0.168	0.015	0.18	0.01	0.018	10
22925	25	0.25	1/4"	0.225	0.025	0.23	0.01	0.029	10
22926	31	0.312	5/16"	0.281	0.025	0.29	0.01	0.029	10
22928	37	0.375	3/8"	0.338	0.025	0.35	0.01	0.029	10
22929	43	0.438	7/16"	0.395	0.025	0.41	0.01	0.029	10
22931	50	0.5	1/2"	0.461	0.035	0.47	0.02	0.039	10
22932	56	0.562	9/16"	0.521	0.035	0.53	0.02	0.039	10
22933	59	0.594	19/32"	0.55	0.035	0.56	0.02	0.039	10
22934	62	0.625	5/8"	0.579	0.035	0.59	0.02	0.039	10
22935	66	0.672	43/64"	0.621	0.035	0.63	0.02	0.039	10
22936	68	0.688	11/16"	0.635	0.042	0.65	0.02	0.046	10
22937	75	0.75	3/4"	0.693	0.042	0.70	0.02	0.046	10
22938	81	0.812	13/16"	0.751	0.042	0.76	0.03	0.046	10
22939	87	0.875	7/8"	0.81	0.042	0.82	0.03	0.046	10
22940	93	0.938	15/16"	0.867	0.042	0.88	0.03	0.046	10
22942	100	1	1"	0.925	0.042	0.94	0.03	0.046	10
22944	106	1.062	1-1/16"	0.982	0.05	1.00	0.03	0.056	10
22945	112	1.125	1-1/8"	1.041	0.05	1.06	0.03	0.056	10
22946	118	1.188	1-3/16"	1.098	0.05	1.12	0.04	0.056	10
22947	125	1.25	1-1/4"	1.156	0.05	1.18	0.04	0.056	10
22948	131	1.312	1-5/16"	1.214	0.05	1.23	0.04	0.056	10
22949	137	1.375	1-3/8"	1.272	0.05	1.29	0.04	0.056	10
22950	143	1.438	1-7/16"	1.333	0.05	1.35	0.04	0.056	10
22951	150	1.5	1-1/2"	1.387	0.05	1.41	0.05	0.056	10
22952	156	1.562	1-9/16"	1.446	0.062	1.47	0.05	0.068	10
22953	162	1.625	1-5/8"	1.503	0.062	1.53	0.05	0.068	10
22954	168	1.688	1-11/16"	1.56	0.062	1.59	0.05	0.068	10
22955	175	1.75	1-3/4"	1.618	0.062	1.65	0.05	0.068	10
22956	187	1.875	1-7/8"	1.735	0.062	1.77	0.05	0.06	10
22957	196	1.969	1-31/32"	1.819	0.062	1.86	0.06	0.068	10
22958	200	2	2"	1.85	0.062	1.89	0.06	0.068	10
22960	212	2.125	2-1/8"	1.964	0.078	2.00	0.06	0.086	5
22962	225	2.25	2-1/4"	2.081	0.078	2.12	0.07	0.086	5
22963	237	2.375	2-3/8"	2.197	0.078	2.24	0.07	0.086	5
22964	243	2.438	2-7/16"	2.255	0.078	2.30	0.07	0.086	5
22965	250	2.5	2-1/2"	2.313	0.078	2.36	0.07	0.086	5
22966	262	2.625	2-5/8"	2.428	0.078	2.48	0.07	0.086	5
22967	275	2.75	2-3/4"	2.543	0.093	2.60	0.07	0.103	2
22968	287	2.875	2-7/8"	2.659	0.093	2.72	0.08	0.1	2
22970	300	3	3"	2.775	0.093	2.84	0.08	0.1	2
22971	350	3.5	3-1/2"	3.237	0.109	3.32	0.09	0.12	2
22972	400	4	4"	3.7	0.109	3.79	0.10	0.12	2
22973	450	4.5	4-1/2"	4.223	0.109	4.31	0.10	0.12	2
22974	500	5	5"	4.692	0.109	4.79	0.11	0.12	2
22975	600	6	6"	5.631	0.125	5.75	0.13	0.139	2

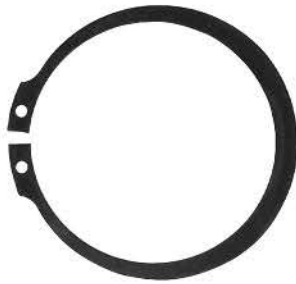

Reference Chart Available
See end of catalogue

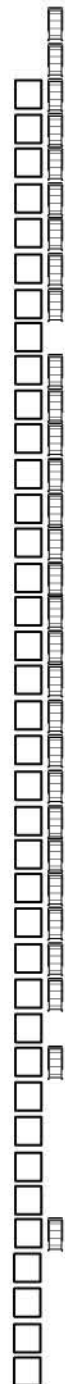

Sizes are approximate. Specifications subject to change without notice.



General Hardware





FARM HARDWARE

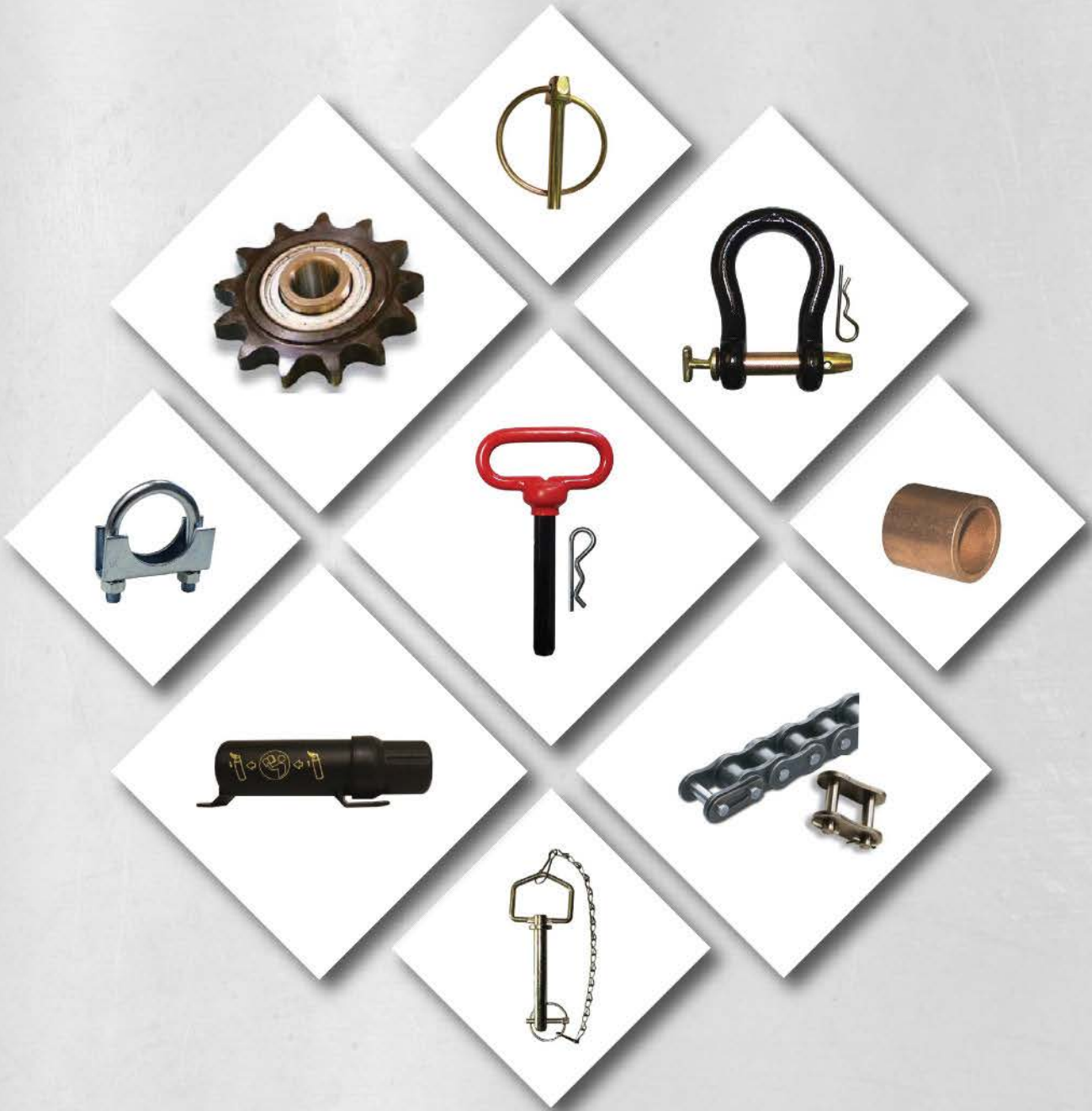

A		Merchandiser - Tractor Linkage Parts	288
Aluminum Document Holder	314	Merchandiser - Weather Caps	288
B		Muffler Clamps	289
Barbed Wire Carrier	292	O	
Bronze Bushings	310	Offset Links	300
C		P	
Cast T-Post Puller	292	Plastic Document Holders	314
Connecting Links	300	Pulleys for A & B Belts	298
Cylinder Pins	301	Pulleys for C Belts	298
D		R	
Drawbars	311	Ratchet Jack	313
F		Roller Chain	299
Fence Post Pounders	291	Roller Chain Breakers	299
Flat Type Idler Pulleys	298	Round Quick Pins	308
Forged Steel Hitch Pins	306	Round Tab Type Quick Pins	308
G		S	
Gate Anchor	291	S/B Bushings	299
Gate Latches	291	Shaft Set Collars	301
Gate Wheels	291	Spring Lock Pins	307
H		Sprockets	293, 294, 295
Hair Pin Clips	309	Square Quick Pins	308
High Strength Hitch Pins	305	Stabilizer Pins	313
Hinge Bolts	290	Steering Wheel Spinners	303
Hinge Clamps	290	Straight Clevises	302
Hinge Straps	290	Stroke Control Segment Kits	301
Hitch Pin - Round Ring Grip	303	T	
Hitch Pins - E-Grip	305	T-Handle Clevis Pins	302
Hitch Pins - Fold Over Handle	304	Top Link Bushings	311
I		Top Link Pins	313
Idler Hubs	297	Top Link Repair Ends	312
Idler Sprockets	295	Tractor Drawbar Hook	302
Industrial Safety Pins	303	Twist Clip Pins	309
L		Twisted Clevises	302
Lad Screw Hinge Bolts	290	U	
Lift Arm Bushings	311	Universal Tail Pipe Hanger	289
Linch Pins	307	V	
Locking Hitch Pins	306	V-Series Hubs	296
M		V-Type Idler Pulleys	298
Merchandiser - Bronze Bushings	287	W	
Merchandiser - Farm Hardware	287	Weather Caps	289
Merchandiser - Farm Hardware Bulk Racks	288	Wire Gripper	292
Merchandiser - Farm Packs	288	Wire Ring Quick Release Pins	303
Merchandiser - Grade 8 Hitch Pins	287	Wire Stretcher	292
Merchandiser - Hitch Pins	287	W-Series Hubs	296, 297
Merchandiser - Muffler Clamps	287	X	
Merchandiser - Pins	287	X-Series Hubs	297
Merchandiser - Stroke Control	288		





Your Trusted Source.

Dynaline Farm Hardware Merchandisers

Dynaline offers merchandisers for almost every product. Merchandisers keep your stock organized, visible and easy to shop.



Farm Hardware



Pins Merchandiser



PART#	CONTENTS
00557	Pins Display Board Only , 24" x 24"
00557K	Full Pins Merchandiser. Includes 00557 display board, 53 pegs (80004) and the products.

i Full product breakdown on page 56



Farm Hardware Merchandiser



PART#	CONTENTS
01101	Farm Hardware Backdrop Only , 48" x 48"
01101K	Full Farm Hardware Plan-o-gram. Includes 01101 and the products.

i Full product breakdown on page 57



Grade 8 Hitch Pins Merchandiser



PART#	CONTENTS
00439	Grade 8 Hitch Pins Display Board Only , 24" x 24"
00439K	Full Grade 8 Hitch Pins Merchandiser. Includes 00439 display board, 22 pegs (80004) and the products.

i Full product breakdown on page 58

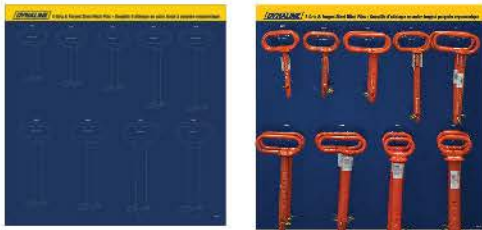

E-Grip & Forged Steel Hitch Pins Merchandiser



PART#	CONTENTS
00441	E-Grip & Forged Steel Hitch Pins Display Board Only , 24" x 24"
00441K	Full E-Grip & Forged Steel Hitch Pins Merchandiser. Includes 00441 display board, 22 pegs (80004) and the products.

i Full product breakdown on page 58



Hitch Pins Merchandiser



PART#	CONTENTS
00435	Hitch Pins Display Board Only , 24" x 24"
00435K	Full Hitch Pins Merchandiser. Includes 00435 display board, 23 pegs (80004) and the products.

i Full product breakdown on page 59

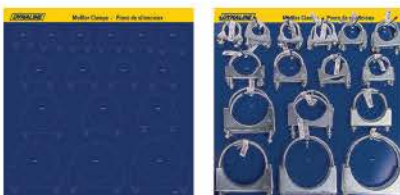

Muffler Clamps Merchandiser



PART#	CONTENTS
00307	Muffler Clamps Display Board Only , 24" x 24"
00307K	Full Muffler Clamps Merchandiser. Includes 00307 display board, 16 pegs (80004) and the products.

i Full product breakdown on page 45



Bronze Bushings Merchandiser

PART#	CONTENTS
00325	Bronze Bushings Display Board Only , 12" x 24"
00325K	Full Bronze Bushings Merchandiser. Includes 00325 display board, 51 pegs (80004) and products.

i Full product breakdown on page 45



Sizes are approximate. Specifications subject to change without notice.



Hitch Pins (Fold Over Handle with Chain) Merchandiser

PART#	CONTENTS
-------	----------

00436 Hitch Pins (FOH) **Display Board Only**, 24" x 24"

00436K "Fold Over Handle" Full Hitch Pins Merchandiser. Includes 00436 display board, 9 pegs (80004) and the products.



00024 Compatible

Full product breakdown on page 59



00024 Compatible

Tractor Linkage Parts Merchandiser

00024 Compatible

PART#	CONTENTS
-------	----------

00438 Tractor Linkage **Display Board Only**, 12" x 24"

00438K Full Tractor Linkage Parts Merchandiser. Includes 00438 display board, 26 pegs (80004) and the products.

Full product breakdown on page 60

Stroke Control Merchandiser

00024 Compatible

PART#	CONTENTS
-------	----------

00297 Stroke Control **Display Board Only**, 12" x 24"

00297K Full Stroke Control Merchandiser. Includes 00297 display board, 17 pegs (80004) and the products.

Full product breakdown on page 60

Weather Caps Merchandiser

PART#	CONTENTS
-------	----------

00226 Weather Caps **Display Board Only**, 24" x 24"

00226K Full Weather Caps Merchandiser. Includes 00226 display board, 26 pegs (80004) and the products.

Full product breakdown on page 61

Farm Packs Merchandiser

PART#	CONTENTS
-------	----------

00620 Farm Packs **Display Board Only**, 24" x 24"

00620K Full Farm Packs Merchandiser. Includes 00620 display board, 37 pegs (80004) and the products.

Full product breakdown on page 61



Farm Hardware Bulk Merchandiser

00024 Compatible

PART#	CONTENTS
-------	----------

00028 Bulk Display Rack Only - 72" x 32" x 24" - 7 shelves

00032K Full Merchandiser. 152 part #'s, 826 pieces. Includes: 4 sign headers, bulk bin interlocking displays, bin labels and the products listed below:

Full product breakdown on page 8

Farm Hardware / Chain and Rigging Bulk Merchandiser

PART#	CONTENTS
-------	----------

00028 Bulk Display Rack Only - 72" x 32" x 24" - 7 shelves

00036K Full Merchandiser. 164 part #'s, 864 pieces. Includes: 4 sign headers, bulk bin interlocking displays, bin labels and the products listed below:

Full product breakdown on page 12



Sizes are approximate. Specifications subject to change without notice.

Farm Hardware

Weather Caps

Clear zinc plated steel. Single bolt installation, silencer block, heat resistant rivets and bushings.

PART#	FITS PIPE DIAMETER	PART#	FITS PIPE DIAMETER
<input type="checkbox"/> 11200	1-1/2" – 1-11/16"	<input type="checkbox"/> 11206	3" – 3-3/16"
<input type="checkbox"/> 11201	1-3/4" – 1-15/16"	<input type="checkbox"/> 11207	3-1/2" – 3-11/16"
<input type="checkbox"/> 11202	2" – 2-3/16"	<input type="checkbox"/> 11208	4" – 4-3/16"
<input type="checkbox"/> 11203	2-1/4" – 2-7/16"	<input type="checkbox"/> 11209	4-1/2" – 4-11/16"
<input type="checkbox"/> 11204	2-1/2" – 2-11/16"	<input type="checkbox"/> 11210	5" – 5-1/4"
<input type="checkbox"/> 11205	2-3/4" – 2-15/16"		



Universal Tail Pipe Hanger

PART#	DESCRIPTION
11220	Open end design for use with assembled clamps.



Muffler Clamps

Clear zinc plated. 3/8" (8.3 mm) wire diameter. Material: Q235 Steel.

PART#	SIZE	PART#	SIZE	PART#	SIZE
11225	1-1/2"	11231	2-1/4"	11236	4"
11226	1-5/8"	11232	2-1/2"	11237	4-1/2"
11227	1-3/4"	11233	2-3/4"	11238	5"
11228	1-7/8"	11234	3"	11239	5-1/2"
11229	2"	11235	3-1/2"	11240	6"
11230	2-1/8"			11241	3-1/4"



Muffler Clamps

- Creates seal and prevents component separation by partially deforming pipe. To create a 360 degree mechanical seal, use two traditional saddle clamps at opposing directions on the connection.



Farm Hardware



Sizes are approximate. Specifications subject to change without notice.



Hinge Straps

Hinge straps for use with 3/8" carriage bolts.

PART#	SIZE	HINGE HOLE DIAMETER
102530	6"	1/2"
102531	8"	1/2"
102532	10"	5/8"
102533	12"	5/8"
102534	14"	3/4"
102535	16"	3/4"



Hinge Clamps

PART#	SIZE	HINGE HOLE DIAMETER
102536	3/4" x 1-3/4"	3/4"
102537	3/4" x 2"	3/4"
102538	5/8" x 1-3/4"	5/8"
102539	5/8" x 2"	5/8"



Hinge Bolts

PART#	SIZE	STRAP SIZE
102540	1/2" x 6"	6" & 8"
102541	5/8" x 8"	10" & 12"
102542	5/8" x 12"	10" & 12"
102543	3/4" x 10"	14" & 16"
102544	3/4" x 12"	14" & 16"



Lad Screw Hinge Bolts

PART#	DESCRIPTION	SIZE	STRAP SIZE
102545	Male	1/2" x 4"	6" & 8"
102546	Male	5/8" x 5"	10" & 12"
102547	Male	3/4" x 6"	14" & 16"
102548	Female, with eye hinge	1/2" x 4"	6" & 8"
102549	Female, with eye hinge	5/8" x 5"	10" & 12"

Sizes are approximate. Specifications subject to change without notice.



Gate Anchor

PART#	DESCRIPTION	OUTSIDE DIAMETER
102554	Gate anchor holds gate open in any position for round tube gates	1-3/4" - 2"



Gate Wheels

PART#	DESCRIPTION
102555	Gate wheels permit easy opening of fence gates and prevent sagging of gate, for tube gates with outside dimensions between 1-5/8" and 2". 8" wheel
102556	"Spring wheel gate adjusts for high ground clearance, prevents sagging of gate, for tube gates with outside dimensions between 1-5/8" and 2". Includes hardware for installation. 10" wheel
102557	Tall gate wheels for high ground clearance, prevents sagging of gate, for tube gates with outside dimensions between 1-5/8" and 2". Includes hardware for installation. 8" wheel



Gate Latches

PART#	DESCRIPTION
102550	2-Way gate latch, for round tube gates 1-5/8" to 2" outside diameter
102551	2-Way gate latch, lockable, accepts padlock, for round tube gates 1-1/4" to 1-1/2" outside diameter
102553	"1-Way gate latch, lockable, accepts padlock, for round tube gates 1-5/8" to 2" outside diameter

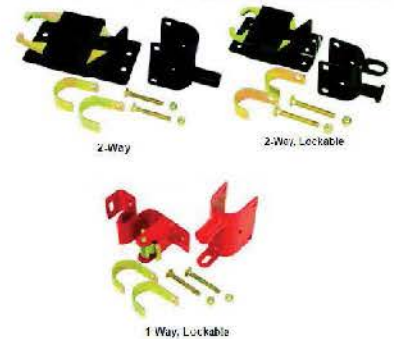

Fence Post Pounders

Drives steel posts into the ground quickly.

PART#	Type	Weight	Length	Inner Dia.	Wall Thickness
102564	Standard duty	12 Lbs.	23 1/4"	2.7"	0.15"
102565	Medium duty	16 Lbs.	31"	2.07"	0.15"
102566	Heavy duty	30 Lbs.	27 1/4"	3.08"	0.23"



12 lb Standard Duty



16 lb Standard Duty



30 lb Standard Duty

Sizes are approximate. Specifications subject to change without notice.





Barbed Wire Carrier

Free spinning design provides safe way to carry and unroll barbed wire by one individual.

PART#	DESCRIPTION
102562	Free spinning design provides safe way to carry and unroll barbed wire by one individual.



Wire Gripper

Wire gripper holds wire in place for fencing maintenance, works with barbed and smooth wire and small diameter cable.

PART#	DESCRIPTION
102563	Wire gripper holds wire in place for fencing maintenance, works with barbed and smooth wire and small diameter cable.



PART#	DESCRIPTION
102568	Metal T-post puller with innovative slot that permits use with different gauges of chain. Use with tractor bucket, chain, handyman jack or s-hook.



With Ratchet Control

Wire Stretcher

PART#	DESCRIPTION
102571	Wire stretcher with ratchet control, for release of wire tension.

Sizes are approximate. Specifications subject to change without notice.





Sprockets for #40 Chain - 1/2" Pitch

PART#	"NUMBER OF TEETH"	OUTSIDE DIAMETER	USE HUB SERIES
102575	12	2-3/16"	V
102576	13	2-1/4"	V
102577	14	2-7/16"	V
102578	15	2-5/8"	V
102579	16	2-13/16"	W
102580	17	3"	W
102581	18	3-1/8"	W
102582	19	3-5/16"	W
102583	20	3-7/16"	X
102584	21	3-5/8"	X
102585	22	3-3/4"	X
102586	23	4"	X
102587	24	4-1/16"	X
102588	26	4-3/8"	X
102589	28	4-11/16"	X
102590	30	5-1/16"	X
102591	32	5-3/8"	X
102592	36	6"	X
102593	40	6-5/8"	X
102594	42	7"	X
102595	45	7-3/8"	X
102596	48	7-7/8"	X
102597	60	9-13/16"	X



Sprockets for #50 Chain - 5/8" Pitch

PART#	"NUMBER OF TEETH"	OUTSIDE DIAMETER	USE HUB SERIES
102598	10	2-1/4"	V
102599	11	2-1/2"	V
102600	12	2-3/4"	W
102601	13	2-7/8"	W
102602	14	3-1/16"	W
102603	15	3-1/4"	W
102604	16	3-7/16"	W
102605	17	3-11/16"	X
102606	18	3-7/8"	X
102607	19	4-1/8"	X
102608	20	4-3/8"	X
102609	21	4-9/16"	X
102610	22	4-3/4"	X
102611	24	5-1/8"	X
102612	26	5-1/2"	X
102613	28	5-7/8"	X



Sizes are approximate. Specifications subject to change without notice.





Sprockets for #50 Chain - 5/8" Pitch - Continuation

PART#	"NUMBER OF TEETH"	OUTSIDE DIAMETER	USE HUB SERIES
102614	30	6-5/16	X
102615	32	6-3/4"	X
102616	34	7-1/16"	X
102617	36	7-9/16"	X
102618	40	8-5/16"	X
102619	42	8-11/16"	X
102620	50	10-1/4"	X
102621	60	12-5/16"	X
102622	96	19-7/16"	X

Sprockets for #60 Chain - 3/4" Pitch

PART#	"NUMBER OF TEETH"	OUTSIDE DIAMETER	USE HUB SERIES
102623	9	2-1/2"	V
102624	10	2-3/4"	V
102625	11	3"	W
102626	12	3-1/4"	W
102627	13	3-1/2"	W
102628	14	3-3/4"	W
102629	15	4"	X
102630	16	4-1/4"	X
102631	17	4-1/2"	X
102632	18	4-11/16"	X
102633	19	5"	X
102634	20	5-1/8"	X
102635	21	5-1/2"	X
102636	22	5-11/16"	X
102637	24	6-1/8"	X
102638	26	6-5/8"	X
102639	28	7-1/8"	X
102640	30	7-5/8"	X
102641	32	8"	X
102642	36	9"	X
102643	40	9-15/16"	X
102644	42	10-1/2"	X
102645	54	13-1/4"	X



Sizes are approximate. Specifications subject to change without notice.



Sprockets for #80 Chain - 1" Pitch

PART#	"NUMBER OF TEETH"	OUTSIDE DIAMETER	USE HUB SERIES
102870	9	3-11/32"	W
102871	10	3-11/16"	W
102872	11	4"	W
102873	12	4-11/32"	X
102874	13	4-21/32"	X
102875	14	4-31/32"	X
102876	15	5-9/32"	X
102877	16	5-5/8"	X
102878	17	5-31/32"	X
102879	18	6-9/32"	X
102880	19	6-19/32"	X
102881	20	6-29/32"	X
102882	21	7-7/32"	X
102883	22	7-9/16"	X
102884	23	7-7/8"	X
102885	24	8-7/32"	X
102886	25	8-17/32"	X
102887	30	10-3/32"	X



Idler Sprockets

PART#	CHAIN SIZE	"NUMBER OF TEETH"	BORE SIZE
102646	40 or 41	17	1/2"
102647	40 or 41	17	5/8"
102648	50	13	1/2"
102649	50	13	5/8"
102650	50	15	1/2"
102651	50	15	5/8"
102652	50	17	1/2"
102653	50	17	5/8"
102654	60	11	1/2"
102655	60	11	5/8"
102656	60	13	1/2"
102657	60	13	5/8"
102658	60	15	1/2"
102659	60	15	5/8"



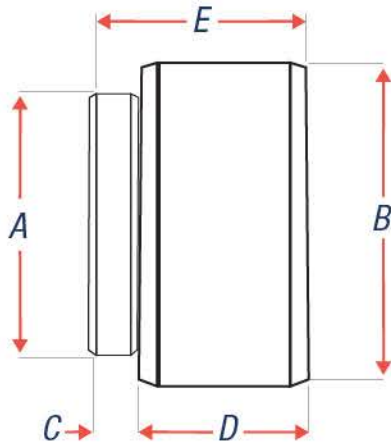

	A	B	C	D	E
V-Series Hubs to fit V-Type Sprocket	1-1/8"	1-7/16"	7/16"	3/4"	1-3/16"
W-Series Hubs to fit W-Type Sprocket	1-5/8"	1-13/16"	7/16"	1"	1-7/16"
X-Series Hubs to fit W-Type Sprocket	2"	2-1/2"	7/16"	1"	1-7/16"



V-Series Hubs (Round Bore)

Round Bore with Keyway and Set Screw

PART#	BORE SIZE
102660	1/2"
102661	5/8"
102662	3/4"
102663	7/8"



W-Series Hubs (Round Bore)

Round Bore with Keyway and Set Screw

PART#	BORE SIZE
102664	1/2"
102665	9/16"
102666	5/8"
102667	11/16"
102668	3/4"
102669	13/16"
102670	7/8"
102671	15/16"
102672	1"
102673	1-1/16"
102674	1-1/8"
102675	1-3/16"
102676	1-1/4"



W-Series Hubs (Hexagon Bore)

Hexagon Bore with Set Screw

PART#	BORE SIZE
102677	7/8"
102678	1"

Sizes are approximate. Specifications subject to change without notice.



W-Series Hubs (Spline Bore)

Spline Bore with Set Screw

PART#	BORE SIZE
102679	1-1/8" x 6
102680	1-3/8" x 6

**X-Series Hubs (Round Bore)**

Round Bore with Keyway and Set Screw

PART#	BORE SIZE
102681	5/8"
102682	11/16"
102683	3/4"
102684	13/16"
102685	7/8"
102686	15/16"
102687	1"
102688	1-1/16"
102689	1-1/8"
102690	1-3/16"
102691	1-1/4"
102692	1-5/16"
102693	1-3/8"
102694	1-7/16"
102695	1-1/2"

**X-Series Hubs (Hexagon Bore)**

Hexagon Bore with Set Screw

PART#	BORE SIZE
102696	7/8"
102697	1"
102698	1-1/8"

**X-Series Hubs (Spline Bore)**

Spline Bore with Set Screw

PART#	BORE SIZE
102699	1-1/8" x 6
102700	1-3/8" x 6

**Idler Hubs**

PART#	HUB SERIES	BORE SIZE
102701	W	5/8" & 1/2"
102702	X	5/8" & 1/2"



Sizes are approximate. Specifications subject to change without notice.



Pulleys for A & B Belts

PART#	OUTSIDE DIAMETER	FITS HUB SERIES	FITS V-BELT STYLE
102703	2-1/2"	V	A or B
102704	3"	V	A or B
102705	3-1/2"	W	A or B
102706	4"	W	A or B
102707	4-1/2"	W	A or B
102708	5"	W	A or B
102709	5-1/2"	W	A or B
102710	6"	W	A or B
102711	6-1/2"	W	A or B
102712	7"	W	A or B
102713	8"	W	A or B
102714	9"	W	A or B
102715	10"	W	A or B
102716	11"	W	A or B
102717	12"	W	A or B
102718	14"	W	A or B
102719	16"	W	A or B



Pulleys for C Belts

PART#	OUTSIDE DIAMETER	FITS HUB SERIES	FITS V-BELT STYLE
102720	6"	X	C
102721	8"	X	C
102722	10"	X	C
102723	12"	X	C



Flat Type Idler Pulleys

PART#	OUTSIDE DIAMETER	BORE SIZE	FLAT BORE WIDTH
102724	1-7/8"	3/8"	3/4"
102725	2-1/4"	3/8"	1"
102726	2-3/4"	5/8"	7/8"
102727	3-1/4"	5/8"	3/4"
102728	3-1/2"	5/8"	1"
102729	4"	5/8"	3/4"
102730	4"	1/2"	1"



V-Type Idler Pulleys

PART#	OUTSIDE DIAMETER	BORE SIZE	GROOVE WIDTH	BELT SIZES
102732	2-1/2"	3/8"	1/2"	4L, 3L, 3V
102733	3"	5/8"	5/8"	5L, 4L, 5V
102734	3-1/2"	5/8"	5/8"	5L, 4L
102735	4"	5/8"	5/8"	5L, 4L
102736	4-1/2"	5/8"	5/8"	5L, 4L
102737	5"	5/8"	5/8"	5L, 4L



Sizes are approximate. Specifications subject to change without notice.



Farm Hardware



S/B Bushings with and without hubs for idler pulleys

PART#	INNER DIAMETER	SHOULDER LENGTH	OVERALL LENGTH	OUTER DIAMETER
102738	3/8"	0.0	0.4	5/8"
102739	3/8"	0.4	0.8	5/8"
102740	1/2"	0.0	0.4	5/8"
102741	1/2"	0.4	0.8	5/8"



102739, 102741



102738, 102740

Roller Chain

High-quality roller chain that meets or exceeds ANSI standards. Pre-stretched, solid rollers with welded bushings to maximize durability.

PART#	CHAIN NUMBER	UNIT (FT.)	PITCH
102742	35	10	3/8"
102743	35	50	3/8"
102744	35-2	10	3/8"
102745	41	10	1/2"
102746	41	50	1/2"
102747	40	10	1/2"
102748	40	50	1/2"
102749	50	10	5/8"
102750	50	50	5/8"
102751	50-2	10	5/8"
102752	50-H	10	5/8"
102753	60	10	3/4"
102754	60	50	3/4"
102755	60-2	10	3/4"
102756	60-H	10	3/4"
102757	80	10	1"
102758	80	50	1"
102759	80-2	10	1"
102760	80-H	10	1"
102761	100	10	1-1/4"
102762	120	10	1-1/2"
102763	A2040	10	1"
102764	A2040	50	1"
102765	A2050	10	1-1/4"
102766	A2050	50	1-1/4"
102767	A2060	10	1-1/2"



Roller Chain Breakers

PART#	DESCRIPTION	FITS
102768	Roller chain breaker	#25 to #60 chain
102769	Roller chain breaker	#60 to #100 chain
102770	Replacement tip assembly	For breaker #102768
102771	Replacement tip assembly	For breaker #102769



Sizes are approximate. Specifications subject to change without notice.





Farm Hardware



Connecting Links

PART#	CHAIN NUMBER	QUANTITY	PITCH
102772	35	4	3/8"
102773	35-2	4	3/8"
102774	41	4	1/2"
102775	40	4	1/2"
102776	50	4	5/8"
102777	50-2	4	5/8"
102778	50-H	4	5/8"
102779	60	3	3/4"
102780	60-2	3	3/4"
102781	60-H	3	3/4"
102782	80	2	1"
102783	80-2	2	1"
102784	80-H	2	1"
102785	100	2	1-1/4"
102786	120	2	1-1/2"
102787	A2040	4	1"
102788	A2050	3	1-1/4"
102789	A2060	3	1-1/4"

Offset Links

PART#	CHAIN NUMBER	QUANTITY	PITCH
102790	35	4	3/8"
102791	35-2	4	3/8"
102792	41	4	1/2"
102793	40	4	1/2"
102794	50	4	5/8"
102795	50-2	4	5/8"
102796	50-H	4	5/8"
102797	60	3	3/4"
102798	60-2	3	3/4"
102799	60-H	3	3/4"
102800	80	2	1"
102801	80-2	2	1"
102802	80-H	2	1"
102803	100	2	1-1/4"
102804	120	2	1-1/2"
102805	A2040	4	1"
102806	A2050	3	1-1/4"
102807	A2060	3	1-1/4"



Sizes are approximate. Specifications subject to change without notice.



Stroke Control Segment Kits

For air & hydraulic cylinders. Cast aluminum alloy.

PART#	FITS SHAFT DIAMETER	SPACER WIDTH (1 EACH)	PACKAGING
102373	7/8" & 1-1/16"	3/4", 1", 1-1/4", 1-1/2"	Clamshell
102375	1-3/4", 1-7/8" & 2"	1", 1-1/2", 2", 4"	Clamshell
55000	1-1/8" to 1-1/4"	3/4", 1", 1-1/4" & 1-1/2"	Clamshell
55001	1-3/8" to 1-1/2"	3/4", 1", 1-1/4" & 1-1/2"	Clamshell
55002	2"	1", 1-1/2", 2", 4-1/4"	Polybag



Stroke Control Segments

PART#	FITS SHAFT DIAMETER	WIDTH	PART#	FITS SHAFT DIAMETER	WIDTH
□ 55003	1-1/8" - 1-1/4"	3/4"	□ 55009	1-3/8" - 1-1/2"	1-1/4"
□ 55004	1-1/8" - 1-1/4"	1"	□ 55010	1-3/8" - 1-1/2"	1-1/2"
□ 55005	1-1/8" - 1-1/4"	1-1/4"	□ 55011	2"	1"
□ 55006	1-1/8" - 1-1/4"	1-1/2"	□ 55012	2"	1-1/2"
□ 55007	1-3/8" - 1-1/2"	3/4"	□ 55013	2"	2"
□ 55008	1-3/8" - 1-1/2"	1"	□ 55014	2"	4-1/4"

Cylinder Pins

For air & hydraulic cylinders. Supplied with clips. S.A.E. 1018-1020 carbon steel hot rolled formed. Includes #66311 Hair Pin.

PART#	PIN DIAMETER	USABLE LENGTH
□ 55030	1"	2-3/4"
□ 55031	1"	3"



Shaft Set Collars

Precision machined shaft set collars for exact fit, size stamped on collar, allen head screw included, yellow zinc dichromate plated.

PART#	INSIDE DIAMETER	OUTSIDE DIAMETER	WIDTH	SET SCREW SIZE
102397	1/4"	1/2"	9/32"	10-32x1/8"
102398	5/16"	5/8"	11/32"	10-32x1/8"
102399	3/8"	3/4"	3/8"	1/4-20x3/16"
102400	7/16"	7/8"	7/16"	1/4-20x1/4"
102401	1/2"	1"	1/2"	1/4-20x1/4"
102402	5/8"	1-1/8"	9/16"	5/16-18x1/4"
102403	11/16"	1-3/8"	5/8"	5/16-18x1/4"
102404	3/4"	1-3/8"	5/8"	5/16-18x1/4"
102405	7/8"	1-1/2"	5/8"	5/16-18x5/16"
102406	1"	1-5/8"	5/8"	5/16-18x5/16"
102407	1-1/8"	1-3/4"	5/8"	5/16-18x5/16"
102408	15/16"	1-5/8"	5/8"	5/16-18x5/16"
102409	1-1/4"	2"	11/16"	3/8-16x3/8"
102410	1-3/8"	2-1/8"	3/4"	3/8-16x3/8"
102411	1-1/2"	2-1/4"	3/4"	3/8-16x3/8"
102412	1-3/4"	2-3/4"	7/8"	1/2-13x1/2"
102413	1-7/8"	2-3/4"	7/8"	1/2-13x1/2"
102414	2"	3"	7/8"	1/2-13x1/2"



Sizes are approximate. Specifications subject to change without notice.

Legend: □ 12x24 □ 24x24 □ Plan-O-Gram □ Rack/End Cap ○ Other





Farm Hardware



Tractor Drawbar Hook

Forged steel. Black enamel painted body & zinc plated T-Pin. Supplied with #66305 Hair Pin.

PART#	CHAIN	A	PIN DIAMETER	PIN LENGTH	OVERALL LENGTH	W.L.L.
66040	5/16"-1/2"	1-5/8"	3/4"	3"	7"	9,200 lb
102524	Grab hook pin to fit Part #66040, 3/4" diameter, 2-1/2" usable length					

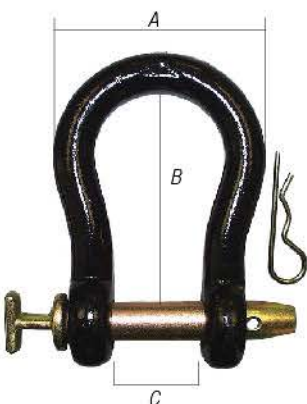

Straight Clevises

Forged steel. Black enamel painted body & zinc plated T-Pin. Supplied with Hair Pin.

PART#	BODY DIAMETER	PIN DIAMETER	A	B	C	W.L.L.	U.L.L.
66029	5/8"	1/2"	3-1/4"	2"	7/8"	6,000 lb	18,000 lb
66030	3/4"	5/8"	3-3/4"	2-1/4"	1-5/16"	12,000 lb	36,000 lb
66031	7/8"	3/4"	4-1/4"	2-3/4"	1-5/16"	16,000 lb	48,000 lb
66032	15/16"	7/8"	4-5/8"	3-1/8"	1-7/16"	20,000 lb	60,000 lb
66033	1"	1"	5-5/16"	3-5/16"	2-1/8"	25,000 lb	75,000 lb



Twisted Clevises

PART#	BODY DIAMETER	CLEVIS OPENING	USABLE LENGTH	PIN DIAMETER	W.L.L.
102496	3/4"	1-5/16"	3-1/2"	5/8"	12,000 lb
102497	7/8"	1-5/16"	3"	3/4"	16,000 lb
102498	7/8"	1-5/16"	3-7/8"	3/4"	16,000 lb
102499	15/16"	1-7/16"	4-1/4"	7/8"	20,000 lb
102500	1"	2-1/8"	5"	1"	25,000 lb



T-Handle Clevis Pins

PART#	PIN DIAMETER	USABLE LENGTH	WEIGHT (LBS.)
102525	1/2"	2-1/4"	0.4
102526	5/8"	3-1/8"	0.5
102527	3/4"	3-1/4"	0.7
102528	7/8"	3-3/4"	1.2
102529	1"	4-1/4"	1.5

Sizes are approximate. Specifications subject to change without notice.

Steering Wheel Spinners

Vinyl coated aluminum knob with chrome plated base. Ball bearing insert for long life. Safe and easy for use with most off-road vehicles.
Not for highway use.

PART#	COLOR	QUANTITY
28327	Red	12 pieces per display box
28329	Black	12 pieces per display box



Industrial Safety Pins

Oil tempered steel. Clear zinc plated finish.

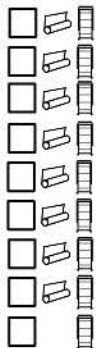

PART#	WIRE	A	B	PACKAGE QUANTITY
66470	1/8"	3-1/8"	1-1/16"	10
66472	3/16"	3-3/8"	1-1/2"	5
66474	1/4"	5-1/4"	1-3/4"	5
66489	3/32"	1-11/16"	5/8"	10
66490	1/8"	2-13/16"	13/16"	10
66491	3/16"	3"	1-1/2"	5
66492	5/32"	3-3/4"	1-1/8"	5
66493	15/64"	5"	1-5/8"	5
66494	15/64"	5"	2-1/4"	5



Wire Ring Quick Release Pins

Spring-loaded ball locks pin into place. C-1010 zinc plated carbon steel pin (detent pin).

PART#	A	B	PACKAGE QUANTITY	PART#	A	B	PACKAGE QUANTITY
102316	3/16"	1"	1	66515	3/8"	1-1/2"	5
102317	3/16"	1-1/2"	1	66516	3/8"	2"	5
102318	3/16"	2"	1	66518	3/8"	2-1/2"	5
66499	1/4"	1"	5	66519	3/8"	3"	5
66500	1/4"	1-1/2"	5	102333	3/8"	4"	5
66501	1/4"	2"	5	102334	7/16"	2"	5
66503	1/4"	2-1/2"	5	102335	7/16"	3"	5
66505	1/4"	3"	5	66520	3/8"	3-1/2"	5
66507	5/16"	1"	5	66524	1/2"	1"	5
66508	5/16"	1-1/2"	5	66525	1/2"	1-1/2"	5
66509	5/16"	2"	5	66526	1/2"	2"	5
66510	5/16"	2-1/2"	5	66527	1/2"	2-1/2"	5
66511	5/16"	3"	5	66528	1/2"	3"	5
66514	3/8"	1"	5	66530	1/2"	3-1/2"	5

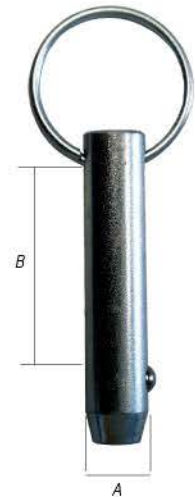

Hitch Pin - Round Ring Grip

S.A.E.1020 high strength stress-proof steel. Clear zinc plated finish. Supplied with hair pin clip.

PART#	PIN DIAMETER (A)	USABLE LENGTH (B)	MIN. BREAK LOAD	HAIR PIN CLIP
66250	3/8"	3"	10,521 lbs	66301



Sizes are approximate. Specifications subject to change without notice.





Farm Hardware

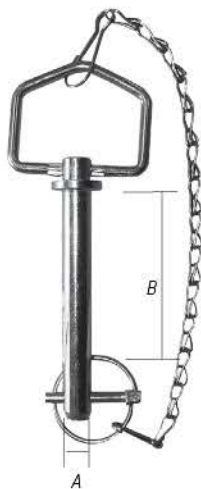

Hitch Pins - Fold Over Handle With Chain

SAE 1045 stress-proof steel. Yellow zinc dichromate plated finish. Supplied with 66451 lynch pin & tenso chain.

	PART#	PIN DIAMETER (A)	USABLE LENGTH (B)	MIN. BREAK LOAD	STEEL TYPE (SAE)	STEEL GRADE
	66280	1/2"	4-1/4"	20,100 lb	1045	EN-8
	102187	1/2"	6-1/4"	20,100 lb	1045	EN-8
	66281	5/8"	4-1/4"	28,400 lb	1045	EN-8
	66282	5/8"	6-1/4"	28,400 lb	1045	EN-8
	66283	3/4"	4-1/4"	40,000 lb	1045	EN-8
	66284	3/4"	6-1/4"	40,000 lb	1045	EN-8
	66285	7/8"	6-1/4"	58,364 lb	1045	EN-8
	66286	1"	6-1/4"	81,170 lb	1045	EN-8
	66287	1-1/8"	6-1/4"	88,930 lb	1045	EN-8
	66288	1-1/4"	6-1/4"	124,198 lb	1045	EN-8

Hitch Pins - Fold Over Handle

SAE 1045 stress-proof steel. Yellow zinc dichromate plated finish. Supplied with hair pin.

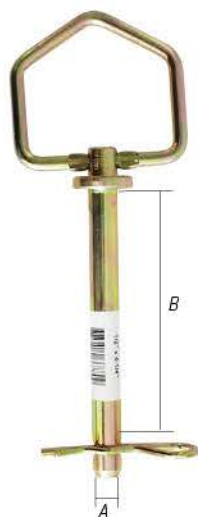

	PART#	PIN DIAMETER (A)	USABLE LENGTH (B)	MIN. BREAK LOAD	HAIR PIN CLIP #	STEEL TYPE (SAE)	STEEL GRADE
	102171	3/8"	4-1/4"	--	66303	1045	EN-8
	66780	1/2"	4-1/4"	20,100 lb	66303	1045	EN-8
	102173	1/2"	6-1/4"	20,100 lb	66303	1045	EN-8
	66781	5/8"	4-1/4"	28,400 lb	66305	1045	EN-8
	66782	5/8"	6-1/4"	28,400 lb	66305	1045	EN-8
	66783	3/4"	4-1/4"	40,000 lb	66302	1045	EN-8
	66784	3/4"	6-1/4"	40,000 lb	66302	1045	EN-8
	66785	7/8"	6-1/4"	58,364 lb	66302	1045	EN-8
	102180	1"	4-1/4"	40,000 lb	66304	1045	EN-8
	66786	1"	6-1/4"	81,170 lb	66304	1045	EN-8
	66787	1-1/8"	6-1/4"	88,930 lb	66304	1045	EN-8
	66788	1-1/4"	6-1/4"	124,198 lb	66304	1045	EN-8
	102184	3/8"	3-1/2"	--	66303	1045	EN-8
	102185	1/2"	3-1/2"	20,100 lb	66303	1045	EN-8

Sizes are approximate. Specifications subject to change without notice.



Hitch Pins - E-Grip

One piece solid hot forged heat treated alloy steel pin and handle. Wider ergonomic handle. Clip pin is included. Bright orange powder coat finish. Rockwell Hardness 36-42 (HRC)

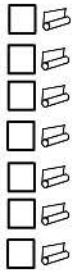

PART#	PIN DIAMETER (A)	USABLE LENGTH (B)	MIN. BREAK LOAD	HAIR PIN CLIP #	STEEL TYPE (SAE)	STEEL GRADE
66872	1/2"	3-1/2"	17,636	66303	1045	EN-8
66873	5/8"	3-3/4"	32,470	66305	1045	EN-8
66874	3/4"	4"	45,500	66302	1045	EN-8
66875	5/8"	6"	31,331	66305	1045	EN-8
66876	3/4"	6-1/4"	29,775	66302	1045	EN-8
66877	7/8"	6-1/2"	58,682	66304	1045	EN-8
66878	1"	6-3/4"	68,121	66304	1045 <td EN-8	



High Strength Hitch Pins - Grade 5

S.A.E. 1040 HiTensile steel. Heat Treated to Grade 5 specification. Rockwell Hardness 25-34 (HRC). Black powder-coated enamel pin. Red vinyl dipped handle. Supplied with hair pin clip.

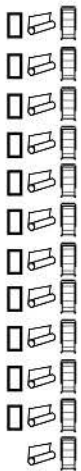

PART#	PIN DIAMETER (A)	USABLE LENGTH (B)	STEEL TYPE (S.A.E.)	STEEL GRADE	MIN. BREAK LOAD	HAIR PIN CLIP #
66251	1/2"	3-5/8"	1040	MS	30,093 lb	66303
66252	5/8"	4"	1040	EN-8	38,779 lb	66305
66253	3/4"	4-1/2"	1040	EN-8	38,064 lb	66302
66254	7/8"	4-1/4"	1040	EN-8	47,021 lb	66304
66255	1"	4-3/4"	1040	EN-8	63,814 lb	66304
66256	5/8"	5-3/4"	1040	EN-8	38,779 lb	66305
66257	3/4"	6-1/2"	1040	EN-8	38,064 lb	66302
66258	7/8"	6-1/2"	1040	EN-8	47,021 lb	66302
66259	1"	7-1/2"	1040	EN-8	63,814 lb	66304
*66260	1-1/8"	8-1/2"	1040	EN-8	69,412 lb	66304
*66261	1-1/4"	8-1/2"	1040	EN-8	75,010 lb	66304
*66263	1-1/2"	8-1/2"	1040	EN-8	78,368 lb	66304
66886	1"	12"	1040	EN-8	64,934 lb	66304
*66887	1-1/8"	12"	1040	EN-8	73,890 lb	66304
*66888	1-1/4"	12"	1040	EN-8	76,129 lb	66304
*66889	1-1/2"	13"	1040	EN-8	80,607 lb	66304
102233	1-3/4"	8-1/2"	1040	EN-8	--	66304
102234	2"	8-1/2"	1040	EN-8	--	66304
*66890	1-3/4"	13"	1040	EN-8	85,086 lb	66455 (Linch pin)

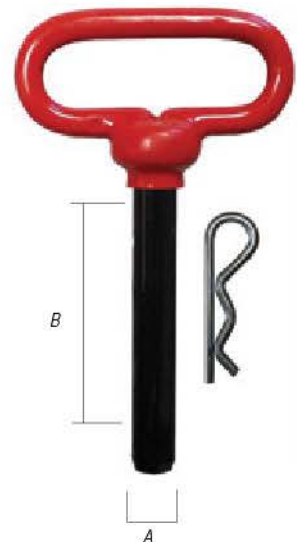

*Rockwell Hardness 19-25 (HRC)

Sizes are approximate. Specifications subject to change without notice.

Legend: 12x24 24x24 Plan-0-Gram Rack/End Cap Other

DYNALINE



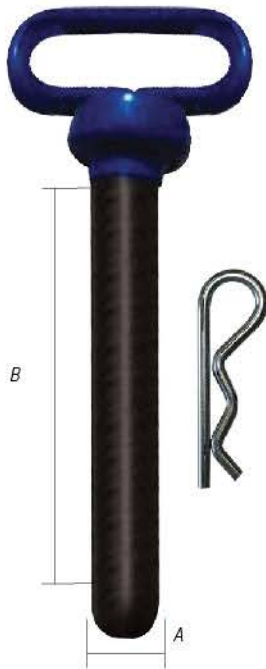

High Strength Hitch Pins - Grade 8

Grade 8 forged blue head hitch pins. SAE 4140H Chromium and molybdenum alloy steel and heat treated to Grade 8 specification. Rockwell Hardness 32-38 (HRC) superior black powder coated finish on pin. Blue vinyl coating on head and handle. Hair pin clip is included.

PART#	PIN DIAMETER (A)	USABLE LENGTH (B)	STEEL TYPE (S.A.E.)	STEEL GRADE	MIN. BREAK LOAD	HAIR PIN CLIP #
<input type="checkbox"/> 66860	1/2"	3-5/8"	4140H Alloy	EN-8	36,945 lb	66303
<input type="checkbox"/> 66861	5/8"	4"	4140H Alloy	EN-8	38,064 lb	66305
<input type="checkbox"/> 66862	5/8"	6"	4140H Alloy	EN-8	39,184 lb	66305
<input type="checkbox"/> 66863	3/4"	4"	4140H Alloy	EN-8	45,901 lb	66302
<input type="checkbox"/> 66864	3/4"	6-1/2"	4140H Alloy	EN-8	47,021 lb	66302
<input type="checkbox"/> 66865	7/8"	4-1/4"	4140H Alloy	EN-8	52,619 lb	66304
<input type="checkbox"/> 66866	7/8"	6-1/2"	4140H Alloy	EN-8	51,499 lb	66304
<input type="checkbox"/> 66867	1"	4-3/4"	4140H Alloy	EN-8	61,575 lb	66304
<input type="checkbox"/> 66868	1"	7"	4140H Alloy	EN-8	62,695 lb	66304
<input type="checkbox"/> 66869	1-1/8"	7"	4140H Alloy	EN-8	72,770 lb	66304
<input type="checkbox"/> 66870	1-1/4"	7"	4140H Alloy	EN-8	76,129 lb	66304
<input type="checkbox"/> 66871	1-1/2"	8-1/2"	4140H Alloy	EN-8	80,607 lb	66304

Farm Hardware

Forged Steel Hitch Pins

Hot forged, heat treated Grade 8, SAE-1541H alloy steel. Rockwell hardness 26-34 (HRC) Solid handle. Bright orange powder coat finish. Supplied with clip.

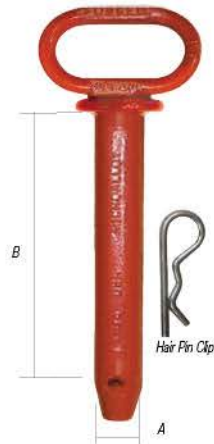

PART#	PIN DIAMETER (A)	USABLE LENGTH (B)	STEEL TYPE (S.A.E.)	MIN. BREAK LOAD	COMPATIBLE HAIR PIN CLIP #
<input type="checkbox"/> 66882	1-1/8"	7"	1541H Alloy	73,890 lb	66304
<input type="checkbox"/> 66883	1-1/4"	7"	1541H Alloy	77,249 lb	66304
66884	1-3/8"	7"	1541H Alloy	82,846 lb	66455 (Linch pin)
66885	1-1/2"	8"	1541H Alloy	80,607 lb	66455 (Linch pin)

Locking Hitch Pins

Grade 5 performance hitch pins with quick release handle for easy removal.







PART#	PIN DIAMETER	USABLE LENGTH	WEIGHT (LBS.)
102248	5/8"	4-1/2"	2.0
102249	3/4"	4-1/2"	2.3
102250	3/4"	6"	2.6
102251	7/8"	4-1/2"	2.6
102252	7/8"	6"	2.9
102253	1"	6"	3.3
102254	1-1/8"	7"	4.1
102255	1-1/4"	7"	4.6
102256	1-1/2"	8"	5.7

Sizes are approximate. Specifications subject to change without notice.

Lynch Pins

Forged C-1010 steel pin. Yellow zinc dichromate plated finish. Available in two package types: Bag and Dynapak (quantities in each are seen below).

	PART#	DESCRIPTION	PACKAGE QUANTITY	PART #	PACKAGE QUANTITY	PIN DIAMETER (A)	USABLE LENGTH (B)	RING DIAMETER (C)	CHAIN LENGTH
	66450	Lynch Pin, standard	10	96450	4	3/16"	1-1/8"	1-1/4"	--
	102343	Lynch Pin, with chain & cotter pin	1	--	--	3/16"	1"	1-1/4"	12"
	66451	Lynch Pin, standard	10	96451	4	1/4"	1-1/2"	1-11/16"	--
	102347	Lynch Pin, short shank	1	--	--	7/16"	1-1/4"	1-7/16"	--
	102348	Lynch Pin, heavy duty, black fits Category 1, 2, & 3 pins*	1	--	--	7/16"	1-1/2"	1-9/16"	--
	102349	Lynch Pin, with chain & cotter pin, black*	1	--	--	7/16"	1-1/2"	1-11/16"	9-3/8"
	66452	Lynch Pin, standard	10	96452	4	5/16"	1-7/16"	1-5/8"	--
	66453	Lynch Pin, standard	10	96453	4	3/8"	1-1/2"	1-3/4"	--
	66454	Lynch Pin, standard	10	96454	4	7/16"	1-7/16"	1-5/8"	--
	102345	Lynch Pin, with chain & cotter pin	1	--	--	7/16"	1-1/4"	1-11/16"	12-5/16"
	66455	Lynch Pin, standard	10	96455	4	7/16"	1-7/8"	2-1/8"	--
	102353	Lynch Pin, long shank	1	--	--	7/16"	1-1/4"	1-9/16"	--
	102354	Lynch Pin, with 12" chain and hook, fits Category 1, & 2 pins	1	--	--	5/16"	1-3/8"	1-5/8"	--
	102355	Lynch Pin, with 12" chain and hook, fits Category 1, & 2 pins	1	--	--	1/4"	1-1/2"	1-9/16"	--



Farm Hardware

Spring Lock Pins

Spring steel wire holds pin in place, grooved pin secures wire, clear zinc finish, carbon steel pin. C-1144 stress-proof steel. (Sold Individually)

	PART#	PIN DIAMETER (A)	USABLE LENGTH (B)
	66244	1/2"	4-1/4"
	102241	1/2"	3-1/2"
	102242	1/4"	1-3/4"
	102243	1/4"	2-1/8"
	102244	5/16"	2-1/4"
	102245	5/16"	2-1/2"
	102246	3/8"	1-1/2"
	102247	3/8"	2-3/8"
	66245	5/8"	4-1/4"
	66246	3/4"	4-1/4"
	66247	3/4"	6-1/4"
	66248	7/8"	6-1/4"
	66249	1"	6-1/4"

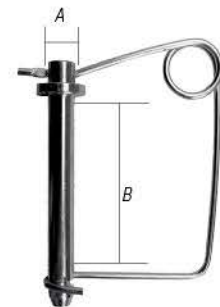

Sizes are approximate. Specifications subject to change without notice.



Dynapak



Round Quick Pins

C-10105 Grade 5 steel. Clear zinc plated finish. Available in two package types: Bag and Dynapak (quantities in each are seen below)

BAG PACK		DYNAPAK		PIN DIAMETER (A)	USABLE LENGTH (B)	C	D	
PART#	PACKAGE QUANTITY	PART #	PACKAGE QUANTITY					
	66460	5	96460	2	1/4"	1-3/8"	1-5/8"	1-5/8"
	102473	1	--	--	1/4"	2-1/2"	1-1/2"	2-3/4"
	66461	5	96461	2	1/4"	1-3/4"	1-5/8"	2"
	102470	1	--	--	5/16"	2-1/4"	1-1/2"	2-11/16"
	102471	1	--	--	3/8"	2-1/4"	1-7/16"	2-11/16"
	66463	5	96463	2	5/16"	1-3/8"	1-5/8"	1-5/8"
	66464	5	96464	2	5/16"	1-3/4"	1-5/8"	2"
	102478	1	--	--	5/16"	2-1/2"	1-5/8"	2-7/8"
	66466	5	96466	2	3/8"	1-3/8"	1-5/8"	1-5/8"
	102483	1	--	--	3/8"	1-3/4"	1-1/2"	2-3/16"
	102484	1	--	--	3/8"	2-1/2"	1-1/2"	3"
	66469	1	96469	1	5/8"	3-1/8"	1-1/2"	3-1/2"

Farm Hardware

Square Quick Pins

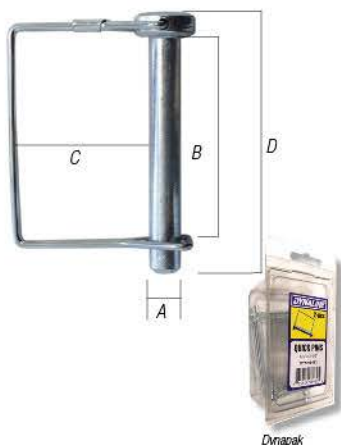

BAG PACK		DYNAPAK		PIN DIAMETER (A)	USABLE LENGTH (B)	C	D	
PART#	PACKAGE QUANTITY	DYNAPAK	PACKAGE QUANTITY					
	102474	1	--	--	1/4"	2-1/4"	1-7/16"	2-15/16"
	66462	5	96462	2	1/4"	2-1/2"	1-5/8"	2-3/4"
	102469	1	--	--	5/16"	2-1/4"	1-1/2"	2-15/16"
	66465	5	96465	2	5/16"	2-1/2"	1-5/8"	2-3/4"
	102480	1	--	--	5/16"	3-1/2"	1-7/8"	4-3/16"
	66467	5	96467	2	3/8"	2-1/4"	1-5/8"	2-1/2"
	66468	5	96468	2	3/8"	2-1/2"	1-5/8"	2-3/4"
	102487	1	--	--	3/8"	3"	1-9/16"	3-3/4"
	102488	1	--	--	3/8"	3-7/16"	2-1/16"	4-1/4"

Round Tab Type Quick Pins

Easier to use than standard wire lock pins. C-1010 steel. Clear zinc plated finish.

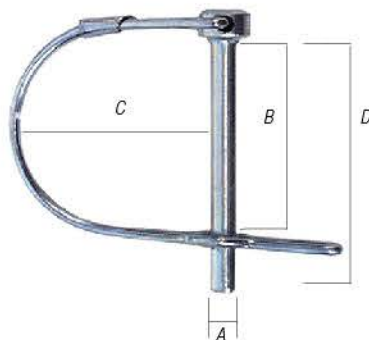

PART#	PACKAGE QUANTITY	PIN DIAMETER (A)	USABLE LENGTH (B)	C	D	
	66531	5	1/4"	1-5/8"	1-5/8"	2-1/8"
	66532	5	1/4"	2"	1-5/8"	2-3/16"
	66533	5	1/4"	2-3/4"	1-5/8"	3-1/8"
	66534	5	5/16"	1-5/8"	1-5/8"	2-1/8"
	66535	5	5/16"	2"	1-5/8"	2-3/16"
	66536	5	5/16"	2-3/4"	1-5/8"	3-1/8"
	66537	5	3/8"	1-5/8"	1-5/8"	2-1/2"
	66538	5	3/8"	2-1/2"	1-5/8"	2-11/16"
	66539	5	3/8"	2-3/4"	1-5/8"	3-1/8"

Sizes are approximate. Specifications subject to change without notice.



Reference Chart Available
 See end of catalogue



Hair Pin Clips - Internal

Oil tempered MB spring wire. Clear zinc plated finish. Available in two package types: Bag and Dynapak (quantities in each are seen below)

	BAG PACK		DYNAPAK								
	PART#	PACKAGE QUANTITY	PART #	PACKAGE QUANTITY	IND.#	WIRE DIAMETER	DRILL HOLE SIZE	MIN. SHAFT DIAMETER	MAX. SHAFT DIAMETER	OVERALL LENGTH	INSIDE EYE DIAMETER
<input type="checkbox"/>	66300	25	96300	10	22	1/16"	5/64"	1/4"	1/2"	1-3/8"	1/4"
<input type="checkbox"/>	66301	25	96301	10	3	3/32"	7/64"	1/4"	1/2"	1-11/16"	7/16"
<input type="checkbox"/>	66302	25	96302	4	6	3/16"	7/32"	5/8"	1"	3-1/4"	7/8"
<input type="checkbox"/>	66303	25	96303	10	7	3/32"	7/64"	3/8"	5/8"	2-5/16"	5/8"
<input type="checkbox"/>	66304	25	96304	5	8	3/16"	7/32"	7/8"	1-1/4"	3-3/4"	7/8"
<input type="checkbox"/>	66305	25	96305	5	9	5/32"	11/64"	3/4"	1-1/8"	3-5/16"	3/4"
<input type="checkbox"/>	66306	25	96306	5	11	1/8"	9/64"	7/16"	3/4"	2-5/8"	9/16"
<input type="checkbox"/>	66307	25	96307	10	16	1/8"	9/64"	1/2"	3/4"	2"	1/2"
<input type="checkbox"/>	66308	10	96308	3	19	1/4"	17/64"	3/4"	1"	4-1/4"	3/4"
<input type="checkbox"/>	102312	1	--	--	--	5/16"	21/64"	1"	1-7/16"	5-15/16"	1-3/8"
<input type="checkbox"/>	66309	25	--	--	1	5/32"	11/64"	1/2"x5/8"	5/8"x1"	3"	1/2"
<input type="checkbox"/>	66310*	25	--	--	2	1/8"	9/64"	3/4"	1-1/8"	3-1/4"	1"
<input type="checkbox"/>	66313	25	--	--	4	11/64"	3/16"	1/2"x3/4"	5/8"x1"	3"	5/8"
<input type="checkbox"/>	66317	25	--	--	17	3/32"	7/64"	3/8"	1/2"	1-9/16"	5/16"
<input type="checkbox"/>	66318	25	--	--	18	1/16"	5/64"	3/8"	1/2"	1-9/16"	5/16"
<input type="checkbox"/>	66320	10	--	--	20	5/16"	21/64"	7/8"	1"	4"	7/8"
<input type="checkbox"/>	66325	25	--	--	25	5/64"	3/32"	5/16"	3/8"	1-3/32"	9/64"
<input type="checkbox"/>	66326	25	--	--	10	5/32"	11/64"	5/8"	1"	2-15/16"	3/4"
<input type="checkbox"/>	66328	25	--	--	14	3/32"	7/64"	1/2"	3/4"	2-1/2"	5/8"

*66310 - Rounded head, see image below.

Twist Clip Pins

Easily attaches and holds more securely than the commonly used "R" clip pin.



PART#	PACKAGE QUANTITY	WIRE DIAMETER	OVERALL LENGTH	FITS PIN DIAMETER	WEIGHT (LBS.)
102303	10	1/8"	2-1/2"	1/2" to 7/8"	0.02
102304	10	5/32"	3-1/32"	5/8" to 1"	0.04
102305	10	3/16"	4-3/32"	3/4" to 1-1/4"	0.06

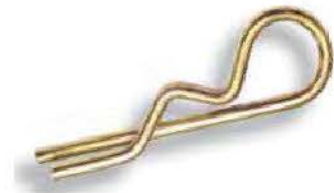

Hair Pin Clips - External

Oil tempered MB spring wire. Clear zinc plated finish. Available in two package types: Bag and Dynapak (quantities in each are seen below)

	BAG PACK		DYNAPAK					
	PART#	PACKAGE QUANTITY	DYNAPAK	PACKAGE QUANTITY	IND.#	WIRE DIAMETER	OVERALL LENGTH	INSIDE EYE DIAMETER
<input type="checkbox"/>	66311	25	96311	5	7XX	7/64"	2-1/16"	7/16"
<input type="checkbox"/>	66312	25	96312	4	10X	11/64"	2-5/8"	3/4"



Farm Hardware

Sizes are approximate. Specifications subject to change without notice.



Bronze Bushings

S.A.E. 841 Bronze material. Oil impregnated.

PART#	THICKNESS	INNER DIAMETER	OUTER DIAMETER	LENGTH	PART#	THICKNESS	INNER DIAMETER	OUTER DIAMETER	LENGTH
55300	1/32"	1/4"	5/16"	3/4"	55326	1/16"	7/8"	1"	1-1/4"
55301	1/16"	1/4"	3/8"	1"	55327	1/8"	7/8"	1-1/8"	1-1/4"
55302	3/32"	1/4"	7/16"	1"	55328	3/16"	7/8"	1-1/4"	1-1/4"
55303	1/8"	1/4"	1/2"	1"	55329	5/32"	15/16"	1-1/4"	1-1/4"
55304	1/32"	5/16"	3/8"	1"	55330	1/8"	1"	1-1/4"	1-1/2"
55305	1/16"	5/16"	7/16"	1"	55331	3/16"	1"	1-3/8"	1-1/2"
55306	1/16"	3/8"	1/2"	1"	55332	1/4"	1"	1-1/2"	1-1/2"
55307	1/8"	3/8"	5/8"	1"	55333	1/8"	1-1/16"	1-5/16"	1-1/2"
55308	3/16"	3/8"	3/4"	1"	55334	1/16"	1-1/8"	1-1/4"	1-1/2"
55309	1/16"	7/16"	9/16"	1"	55335	1/8"	1-1/8"	1-3/8"	1-1/2"
55310	3/32"	7/16"	5/8"	1"	55336	3/16"	1-1/8"	1-1/2"	1-1/2"
55311	1/16"	1/2"	5/8"	1"	55337	1/8"	1-3/16"	1-7/16"	1-1/2"
55312	3/32"	1/2"	11/16"	1"	55338	5/32"	1-3/16"	1-1/2"	1-1/2"
55313	1/8"	1/2"	3/4"	1"	55339	1/8"	1-1/4"	1-1/2"	1-1/2"
55314	5/32"	1/2"	13/16"	1"	55340	3/16"	1-1/4"	1-5/8"	1-1/2"
55315	3/16"	1/2"	7/8"	1"	55341	1/8"	1-3/8"	1-5/8"	1-1/2"
55316	3/32"	9/16"	3/4"	1"	55342	3/16"	1-3/8"	1-3/4"	1-1/2"
55317	1/8"	9/16"	13/16"	1"	55343	5/32"	1-7/16"	1-3/4"	1-1/2"
55318	1/16"	5/8"	3/4"	1-1/4"	55344	1/8"	1-1/2"	1-3/4"	1-1/2"
55319	3/32"	5/8"	13/16"	1-1/4"	55345	3/16"	1-1/2"	1-7/8"	1-1/2"
55320	1/8"	5/8"	7/8"	1-1/4"	55346	3/16"	1-5/8"	2"	1-1/2"
55321	3/16"	5/8"	1"	1-1/4"	55347	1/8"	1-3/4"	2"	1-1/2"
55322	1/16"	3/4"	7/8"	1-1/4"	55348	3/16"	1-3/4"	2-1/8"	1-1/2"
55323	3/32"	3/4"	15/16"	1-1/4"	55349	1/8"	2"	2-1/4"	1-1/2"
55324	1/8"	3/4"	1"	1-1/4"	55350	3/16"	2"	2-3/8"	1-1/2"
55325	3/32"	13/16"	1"	1-1/4"					



Bronze Bushings

Bronze sleeve bushings or bronze bearings are hard and strong, as opposed to brass bushings, which are softer and more easily deform. Thus, bronze bushings have longer lifespans than brass bushing sleeves. They resist shock and impact, wear and corrosion.

They require an external lubricant, for example grease or oil, at installation and during operation to reduce friction and wear.

Sizes are approximate. Specifications subject to change without notice.



Lift Arm Bushings

Carbon steel. Yellow zinc dichromate plated finish.

PART#	REFERENCE#	CATEGORY	INSIDE DIAMETER	OUTSIDE DIAMETER	OVERALL LENGTH
102066	--	0-1	5/8"	7/8"	1-3/8"
□ 66608	0351	1 to 2	7/8"	1-1/8"	1-3/4"
102068	--	1-2	7/8"	1-1/8"	1-3/8"
□ 66610	3009	2 to 3	1-1/8"	1-7/16"	1-3/4"
102070	--	2-3	1-1/8"	1-7/16"	3-1/4"
□ 66612	3010	2 to 3	1-1/8"	1-7/16"	2-1/2"
102072	--	2-3	1-1/8"	1-7/16"	2-3/4"
102073	--	1	7/8"	1-1/8"	4"
102075	--	2	1-1/8"	1-7/16"	4"



Top Link Bushings

Carbon steel. Yellow zinc dichromate plated finish.
 Used in the pin hole of a top link to allow a smaller category pin to fit.

PART#	REFERENCE#	CATEGORY	INSIDE DIAMETER	OUTSIDE DIAMETER	OVERALL LENGTH
□ 66602	0353	1 to 2	3/4"	1"	2"
□ 66604	3008	2 to 3	1"	1-1/4"	2"
102062	--	0-1	5/8"	3/4"	1-5/8"
102063	--	1-2	3/4"	1"	1-5/8"
102064	--	1-2	3/4"	1"	1-5/16"
102065	--	2-3	1"	1-1/4"	1-5/8"



Drawbars

One piece 3-point hitch cross drawbars to fit Category 0 through Category 3 tractors.

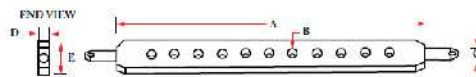

PART#	CAT.	NUMBER OF HOLES	A LIFT ARM SPACING	B HOLE DIAMETER	C PIN DIAMETER	D THICKNESS	E WIDTH
102077	0	7	20"	5/8"	5/8"	3/4"	2"
102078	0/1	7	20"	3/4"	7/8"	1"	2-1/2"
102079	1	11	26"	3/4"	7/8"	1"	2-1/2"
102082	2	13	32"	3/4"	1-1/8"	1-1/4"	3



Farm Hardware

Sizes are approximate. Specifications subject to change without notice.





Top Links

Carbon steel, forged & welded. With grease fitting, nut welded. Yellow zinc dichromate plated finish. UNC Coarse Thread.

PART#	REFERENCE#	CATEGORY	HOLE DIAMETER	THREAD DIAMETER	ADJUSTMENT (OUTSIDE TO OUTSIDE)
102000	--	0	5/8"	3/4" NC	13" - 18"
66619	480	0	5/8"	3/4"	11" - 16"
102004	--	1	3/4"	1-1/8" NC	25" - 35"
102006	--	1	3/4"	1-1/8" NC	16" - 23"
66620	331	1	3/4"	1-1/8"	21" - 31"
66621	338	1 & 2	3/4" & 1"	1-1/8" & 1-1/4"	21" - 32"
66622	337	2	1"	1-1/8"	25" - 36"
102011	--	2	1"	1-1/4" NC	20" - 30"
102015	--	3	1-1/4"	1-3/8" NC	26" - 35"
66624	336	2	1"	1-1/8"	21" - 32"



Top Link Repair Ends

Carbon steel, forged & welded. Yellow zinc dichromate plated finish. UNC Coarse Thread.

PART#	REFERENCE#	CATEGORY	HOLE DIAMETER	THREAD DIAMETER	THREAD LENGTH
102016	--	0	5/8"	3/4" NC (RH)	3-1/2"
102017	--	0	5/8"	3/4" NC (LH)	3-1/2"
66625	342	1	3/4"	1-1/8" LH	6"
66626	343	1	3/4"	1-1/8" RH	6"
102020	--	2	1"	1-1/4" NC (LH)	5-1/2"
102021	--	2	1"	1-1/4" NC (RH)	5-1/2"
66627	346	2	1"	1-1/8" LH	6-1/2"
66628	347	2	1"	1-1/8" RH	6-1/2"
102024	--	3	1-1/4"	1-3/8" NC (LH)	7-1/4"
102025	--	3	1-1/4"	1-3/8" NC (RH)	7-1/4"



Sizes are approximate. Specifications subject to change without notice.

Ratchet Jack

Heavy duty. Replace hydraulic cylinders or old screw jacks in those applications where infrequent adjustment is needed. Clip pins and handle included.

PART#	A	B	C	THREAD DIAMETER	LENGTH CLOSED	LENGTH EXTENDED
66642	1-1/2"	1"	2-3/4"	1-1/4"	20"	28"



Stabilizer Pins

Stabilizer stub pins for Ford, Ferguson, and other stabilizer kits. Yellow zinc dichromate plated.

PART#	PIN DIAMETER	USABLE LENGTH	OVERALL LENGTH	THREAD DIAMETER	WASHER & NUT
102095	7/8"	1/2"	3-1/4"	7/8" NF	Yes
102096	7/8"	3/8"	2-5/8"	5/8" NF	Yes
102097	7/8"	3/8"	2-5/8"	5/8" NF	No
102098	7/8"	1-1/4"	3-1/8"	5/8" NF	Yes
102099	7/8"	1-1/4"	3-1/8"	5/8" NF	No
102100	7/8"	1/2"	2-5/8"	5/8" NF	Yes
102101	7/8"	1/2"	2-5/8"	5/8" NF	No
102102	7/8"	11/16"	3-1/8"	3/4" NF	Yes



Top Link Pins

Carbon steel, forged & welded. Yellow zinc dichromate plated finish. UNC Coarse Thread.

	PART#	REFERENCE#	CATEGORY	PIN DIAMETER	USABLE LENGTH	OVERALL LENGTH
□	66560	73	1	3/4"	2-3/4"	4-1/2"
□	66561	74	1	3/4"	3-7/8"	5-1/2"
□	66562	76	2	1"	3-9/16"	5-1/4"
	66563	7715	1	3/4"	4-3/4"	6-3/8"
	102152	--	2	1"	4-3/8"	6"
□	66565	3011	2	1"	4-5/16"	6"
	102154	--	2	1"	5-3/8"	7-1/16"
	66566	7711	3	1/4"	4-5/8"	6-1/2"
	66567	7706	0	5/8"	3"	4-7/16"





Farm Hardware



Lift Arm Pins

Carbon steel. Yellow zinc dichromate plated finish. UNF Thread (Unified National Fine)

	PART#	REFERENCE#	CATEGORY	PIN DIAMETER	THREAD DIAMETER	USABLE LENGTH	OVERALL LENGTH
□	66580	200	1	7/8"	7/8" NF	1-3/4"	5-1/2"
□	66581	3000	1	7/8"	7/8" NF	Adjustable	6-1/4"
□	66582	3004	1	7/8"	7/8" NF	2-1/4"	6-1/2"
□	66583	3001	1 to 2	1-1/8"	7/8" NF	Adjustable	5-3/16"
	66584	7243	2 to 3	1-7/16"	1-1/8" NF	1-7/8"	5-3/4"
NEW	102134	--	3	1-7/16"	1-3/8" NF	2"	5-7/8"
□	66585	202	1 to 2	1-1/8"	7/8" NF	1-3/4"	5-1/4"
	66586	7249	1 to 2	7/8-11/8"	1" NF	2-1/6"	8"
□	66587	3022	2 to 1	7/8"	1-1/8" NF	1-3/4"	5-3/4"
NEW	102132	--	2 - 3	1-7/16"	1-1/8" NF	Adjustable	6-1/2"
□	66588	3006	2	1-1/8"	1-1/8" NF	1-3/4"	6-1/8"
	66589	3002	2	1-1/8"	1-1/8" NF	Adjustable	6-1/8"
□	66590	211	1	7/8"	7/8" NF	Adjustable	5-5/16"
	66591	7220	0	5/8"	5/8" NF	Adjustable	3-7/8"
NEW	102116	--	0	5/8"	5/8" NF	1-7/16"	3-7/8"
NEW	102117	--	0 - 1	7/8"	5/8" NF	Adjustable	4-1/2"
NEW	102118	--	1 - 0	5/8"	7/8" NF	2"	5"
NEW	102124	--	1	7/8"	5/8" NF	1-3/4"	4-1/2"
	66592	7246	1 to 2	1-1/8"	7/8" NF	2-1/4"	6-5/16"



Clevis Type Draw Pins

Stabilizer stub pins for Ford, Ferguson, and other stabilizer kits. Yellow zinc dichromate plated.

	PART#	CAT.	TYPE	PIN DIAMETER	USABLE LENGTH	OVERALL LENGTH
	102141	3	Head	1-7/16"	4-11/16"	6"
NEW	102144	2	Head	1-1/8"	5"	6"
NEW	102145	1 & 2	Head	7/8"	3-1/4" & 4-1/2"	9-1/4"
NEW	102146	1	Head	7/8"	4"	5-1/4"

Sizes are approximate. Specifications subject to change without notice.



Plastic Document Holders

Molded from high density polypropylene, weather and impact resistant. Protects documents from damage. Mounts onto machines for easy access. O-Ring sealed. Screw top lid.



PART#	DESCRIPTION
17710	Plastic Holder 2-1/4" diameter x 12-1/2" long
17720	Plastic Holder 2" diameter x 12-1/2" long
17730	Plastic Holder 3-1/4" diameter x 14" long
17731	Tether for plastic holder 17720 and 17730

Aluminum Document Holder

Made from corrosion resistant aluminum. Protects documents from the elements.

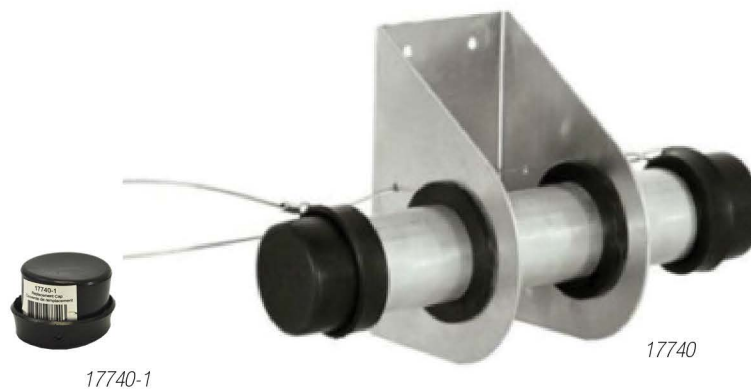

PART#	DESCRIPTION
17740	1.5" inside diameter x 9" long
17740-1	Rubber cap replacement for 17740

Sizes are approximate. Specifications subject to change without notice.





SHOP SUPPLIES & EQUIPMENT





A		
Air Hose Reels - Heavy Duty Seel Frame	318	
C		
Caster & Wheels Plan-O-Gram	317	
Caster Swivel Wheels	320	
Caster Wheel With Side Locking Brake	320	
Caster Wheels With Rigid Top Plate	320	
Convertible Mechanic Creeper/Stool	321	
D		
Detachable Vehicle Ramps	325	
Dual Bracket Heavy Duty Grease Hose Reel	318	
F		
Flat Free Caster Swivel Wheel	321	
Flat Free Caster Wheel	321	
Flat free Wheels	319	
G		
Garage Parking Stops	325	
H		
Heavy Duty Jack Stand -3 Ton	322	
Heavy Duty Jack Stand -3 Ton	322	
Hydraulic Floor Jack -2 Ton	322	
I		
Industrial Hose Reel	318	
J		
Jack Stands	322	
L		
Low Profile Hydraulic Floor Jack - 3 Ton	322	
Low Profile Vehicle Ramp	325	
M		
Merchandiser - Small Wheel Rack	317	
P		
Pneumatic Caster Swivel Wheel	321	
Pneumatic Wheels	319	
Pneumatic/Hydraulic Bottle Jack - 20 Ton	323	
R		
Retractable Hose Reel	318	
S		
Scissor Jack -2 Ton	322	
Semi-Pneumatic Wheel	319	
Shop Towels	324	
Stackable Vehicle Ramp	325	
T		
Tire Dolly	324	
Tire Racking Dolly	324	
U		
Utility Farm Jack	323	
Utility Farm Jack Maintenance Kit	323	
W		
Wall-Mount Folding Tire Rack	324	





Your Trusted Source.

Dynaline Shop Supplies & Equipment Merchandisers

Dynaline offers merchandisers for almost every product. Merchandisers keep your stock organized, visible and easy to shop.



Small Wheel Rack Merchandiser

PART#	CONTENTS
80103	Freestanding Wheel Rack Only , 21"x 21"(footprint) x 72"(tall).
80103K	Full Wheel Rack Merchandiser. An assortment of pneumatic and flat free wheels on this space saving wheel rack. All metal with black enamel painted finish. Includes: 10" x 3" Dynaline "Replacement Wheels" decal and all products.

Full product breakdown on page 62

Sizes are approximate. Specifications subject to change without notice.



Caster & Wheels Plan-O-Gram

PART#	CONTENTS
00300K	Full Caster Wheels Plan-O-Gram. Includes header and products listed below.
00302K	Full Caster & Assorted Wheels Plan-O-Gram Includes header, bins and products.

Full product breakdown on page 62 & 63



Shop Supplies & Equipment





11363

Air Hose Reels - Heavy Duty Steel Frame

Corrosion resistant powder coat finish. Features spring tension brake and solid brass swivel. Mounts on floor, wall or workbench.

PART#	REEL CAPACITY	HOSE DIAMETER	INLET DIAMETER	HOSE OUTLET
11362	100 ft.	3/8"	3/8" NPT	3/8" NPT
11363	50 ft.	3/8"	3/8" NPT	3/8" NPT



Industrial Hose Reel

Heavy duty steel assembly. Corrosion resistant powder coated finish. Ratchet gear locks reel at desired hose length. 3/8" heavy duty industrial grade rubber hose. Use for **air and water**, 3/8" NPT brass fitting.

PART#	HOSE LENGTH	HOSE DIAMETER	MAXIMUM PRESSURE	COLOUR
11369	50 ft.	3/8"	300 PSI	Red
11371	100 ft.	3/8"	300 PSI	Black & Yellow



11359

Retractable Hose Reel - Silver Series

Auto rewind, heavy duty steel assembly. Powder coated finish. Self locking mechanism, heavy duty springs. Robust for commercial use. Industrial grade hose for **water, oil and air**.

PART#	HOSE LENGTH	HOSE DIAMETER	MAXIMUM PRESSURE
11359	35 ft.	1/4"	300 PSI
11360	50 ft.	3/8"	300 PSI
11361	50 ft.	1/2"	300 PSI



Dual Bracket Heavy Duty Grease Hose Reel

Heavy duty **grease** hose reel with 1/4" hose diameter and a 50' hose length. It features a heavy duty spring and gauge for retraction.







PART#	HOSE LENGTH	HOSE DIAMETER	MAXIMUM PRESSURE
11373	50 ft.	1/4"	5,000 PSI

Replacement Parts for Hose Reels

PART#	DESCRIPTION	FOR SERIES	PART#	DESCRIPTION	FOR SERIES
11359-1	1/4" Hose stopper	11359	11359-3	1/4" FNPT swivel	11359,11360
11369-1	3/8" Hose stopper	11360,11369,11371	11361-2	1/2" FNPT swivel	11361
11361-1	1/2" Hose stopper	11361	11369-4	LD Locking pawl accessory	11369
11369-2	4-way Roller bracket assembly	11369	11371-2	LD Locking pawl accessory	11371
11371-1	4-way roller bracket assembly	11371	11359-4	HD Locking pawl accessory	11359,11360,11361
11359-2	4-way roller bracket assembly	11359	11373-1	1/4" NPT Swivel replacement	11373
11360-1	4-way roller bracket assembly	11360	11373-2	Hose roller guide accessories	11373
11369-3	1/4" FNPT swivel	11369,11371	11373-3	1/4" Hose stopper	11373
11362-1	3/8" FNPT swivel	11362,11363			

Pneumatic Wheels







Rugged steel construction. Proof tested & certified. Use on straight or curved tracks. Adjustable to various beams. Axle bore is 5/8" (except Part# 80117 which has an axle bore of 3/4"). Wheels are tubeless.

PART#	TIRE SIZE	HUB WIDTH	WHEEL DIA.	TIRE WIDTH	RIM DIA.	HUB TYPE	TREAD PATTERN	LOAD RATING
 80101	2.50-4	1.75"	8.5"	2.275"	4.8"	Offset	Lug	180 lb
 80105	4.10/3.50-4	2.28"	10"	3.25"	4.9"	Offset	Sawtooth	280 lb
 80109	3.00-4	1.53"	10"	3"	4.8"	Offset	Diamond	260 lb
 80113	5.00-6	3.15"	13"	4.45"	6.79"	Offset	Jag	390 lb
 80116	4.80/4.00-8	6"	15.08"	3.66"	8.8"	Center	Smooth	390 lb
 80117	4.80/4.00-8	6"	15.08"	3.66"	8.8"	Center	Smooth	390 lb



Flat Free Wheels

Axle bore size is 5/8". Steel rims. Tubeless. Comes with bearings and grease zerks.

PART#	TIRE SIZE	HUB WIDTH	WHEEL DIA.	TIRE WIDTH	RIM DIA.	HUB TYPE	TREAD PATTERN	LOAD RATING
 80102	2.50-4	1.75"	8.5"	2.275"	4.8"	Offset	Lug	160 lb
 80107	4.10/3.50-4	2.28"	10"	3.25"	4.9"	Offset	Jag	260 lb
 80111	3.00-4	1.53"	10"	3"	4.8"	Offset	Diamond	240 lb
 80112	3.00-4	2.59"	10"	3"	4.8"	Center	Diamond	240 lb
 80115	5.00-6	3.15"	13"	4.45"	6.79"	Offset	Jag	370 lb
 80118	4.80/4.00-8	6"	15"	3.66"	8.8"	Center	Smooth	370 lb



Semi-Pneumatic Wheel

Semi-pneumatic wheel with a durable plastic lightweight rim and hub. Axle bore size is 1/2".

PART#	TIRE SIZE	HUB WIDTH	WHEEL DIA.	TIRE WIDTH	RIM DIA.	HUB TYPE	TREAD PATTERN	LOAD RATING
80229	4.10/3.50-4	2.28"	10"	3.25"	4.67"	Offset	Jag	260 lb



Replacement Bearings For Wheels

PART#	AXLE BORE DIAMETER	OUTSIDE DIAMETER
80121	5/8"	1-15/32"
80122	1/2"	1-15/32"
80123	3/4"	1-15/32"



Shop Supplies & Equipment



Sizes are approximate. Specifications subject to change without notice.

Caster Wheels With Rigid Top Plate

For general use in hardware, factory and warehouse. Strong, durable, economical. Corrosion resistant zinc finish. Hard rubber wheels, black.



	PART#	WHEEL DIA.	WHEEL WIDTH	OVERALL HEIGHT	AXLE SIZE	MOUNTING HOLE DIA.	LOAD RATING (LB)	PLATE SIZE (IN.)
	31015	1-1/2"	7/8"	2"	1/4"	1/4"	77 lb	2-3/8" x 1-1/2"
	31020	2"	1"	2-1/2"	1/4"	1/4"	110 lb	1-3/4" x 2-5/8"
	31025	2-1/2"	1-1/8"	3-3/16"	5/16"	5/16"	165 lb	2-1/8" x 3-3/4"
	31030	3"	1-1/4"	3-13/16"	3/8"	5/16"	210 lb	2-1/2" x 4"
	31040	4"	1-5/16"	5"	7/16"	3/8"	240 lb	2-1/4" x 5"
	31050	5"	1-1/4"	6-3/16"	3/8"	5/16"	220 lb	3-5/8" x 2-1/2"
	31060	6"	2"	7-1/2"	15/32"	7/16"	660 lb	4-1/2" x 4"
	31080	8"	2"	9-1/2"	15/32"	7/16"	700 lb	4-1/2" x 4"

Caster Swivel Wheels

For general use in hardware, factory and warehouse. Strong, durable, economical. Corrosion resistant zinc finish. Hard rubber wheels, black.



	PART#	WHEEL DIA.	WHEEL WIDTH	OVERALL HEIGHT	AXLE SIZE	MOUNTING HOLE DIA.	LOAD RATING (LB)	PLATE SIZE (IN.)
	32015	1-1/2"	7/8"	2"	1/4"	1/4"	77 lb	2-3/8" x 1-3/4"
	32020	2"	1"	2-1/2"	1/4"	1/4"	110 lb	1-7/8" x 2-9/16"
	32025	2-1/2"	1-1/8"	3-3/16"	5/16"	5/16"	165 lb	2-3/4" x 3-13/16"
	32030	3"	1-1/4"	3-13/16"	3/8"	5/16"	210 lb	3-1/8" x 4-1/8"
	32040	4"	1-5/16"	5"	7/16"	3/8"	240 lb	4" x 5-1/8"
	32050	5"	1-1/4"	6-3/16"	3/8"	5/16"	220 lb	3-5/8" x 2-1/2"
	32060	6"	2"	7-1/2"	15/32"	7/16"	660 lb	4-1/2" x 4"
	32080	8"	2"	9-1/2"	15/32"	7/16"	700 lb	4-1/2" x 4"

Caster Wheel With Side Locking Brake

For general use in hardware, factory and warehouse. Strong, durable, economical. Corrosion resistant zinc finish. Hard rubber wheels, black.



	PART#	WHEEL DIA.	WHEEL WIDTH	OVERALL HEIGHT	AXLE SIZE	MOUNTING HOLE DIA.	LOAD RATING (LB)	PLATE SIZE (IN.)
	33015	1-1/2"	7/8"	2"	1/4"	1/4"	77 lb	2-3/8" x 1-3/4"
	33020	2"	1"	2-1/2"	1/4"	1/4"	110 lb	1-7/8" x 2-9/16"
	33025	2-1/2"	1-1/8"	3-3/16"	5/16"	5/16"	165 lb	2-3/4" x 3-13/16"
	33030	3"	1-1/4"	3-13/16"	3/8"	5/16"	210 lb	3-1/8" x 4-1/8"
	33040	4"	1-5/16"	5"	7/16"	3/8"	240 lb	4" x 5-1/8"
	33050	5"	1-1/4"	6-3/16"	3/8"	5/16"	220 lb	3-5/8" x 2-1/2"
	33060	6"	2"	7-1/2"	15/32"	7/16"	660 lb	4-1/2" x 4"
	33080	8"	2"	9-1/2"	15/32"	7/16"	700 lb	4-1/2" x 4"



Pneumatic Caster Wheel With Rigid Top Plate

Rigid caster wheel with 4.10/3.50-4 pneumatic tube tire. 50 PSI, 4-ply sawtooth tread. 3-piece split 1.8mm rim with curled edges. 4" centered hub with valve stem and grease fitting on same side of rim. 5/8" precision ball bearing. Frame thickness is 5.5 mm.



Pneumatic Caster Swivel Wheel

Swivel caster wheel with 4.10/3.50-4 pneumatic tube tire. Premium 50 PSI, 4-ply sawtooth tread. 3-piece split 1.8mm rim with curled edges. 4" centered hub with valve stem and grease fitting on same side of rim. 5/8" precision ball bearing. Frame thickness is 5.5 mm.



PART#	WHEEL DIAMETER	WHEEL WIDTH	OVERALL HEIGHT	AXLE SIZE	MOUNTING HOLE DIA.	LOAD RATING (LB)	PLATE SIZE (IN.)
31101	10"	3-3/8"	12"	5/8"	7/16"	500 lb	4" x 4-1/2"

Flat Free Caster Wheel With Rigid Top Plate

Rigid caster wheel with flat free tire. 1.8 mm rim, 5/8" ball bearing.



PART#	WHEEL DIAMETER	WHEEL WIDTH	OVERALL HEIGHT	AXLE SIZE	MOUNTING HOLE DIA.	LOAD RATING (LB)	PLATE SIZE (IN.)
31102	10"	3-3/8"	12"	5/8"	7/16"	360 lb	4" x 4-1/2"

Flat Free Caster Swivel Wheel

Swivel caster wheel with flat free tire. 1.8 mm rim, 5/8" ball bearing.



PART#	WHEEL DIAMETER	WHEEL WIDTH	OVERALL HEIGHT	AXLE SIZE	MOUNTING HOLE DIA.	LOAD RATING (LB)	PLATE SIZE (IN.)
31103	10"	3-3/8"	12"	5/8"	7/16"	360 lb	4" x 4-1/2"

Convertible Mechanic Creeper/Stool

Converts easily from creeper to stool. Sturdy and durable pipe frame. Thick padded vinyl cushions for maximum comfort. Equipped with 6 casters for increase mobility. Powder coated finish.

PART#	CAPACITY
11575	300 lbs



Sizes are approximate. Specifications subject to change without notice.



2 Ton Scissor Jack

Saddle top type, collapsible, steel scissor jack. Meets ASME 2014 safety standards. Red power coated finish.

PART#	CAPACITY	LIFTING RANGE
11557	4,000 lbs	4-1/8" to 15-3/8"



2 Ton Hydraulic Floor Jack

This jack features a safety overload system to prevent use beyond rated capacity. Rotating heavy duty saddle. Meets ASME 2014 safety standards. Built in carrying handle. Red powder coated finish.

PART#	CAPACITY	LIFTING RANGE
11558	4,000 lbs	5-5/16" TO 13-3/16"



3 Ton Low Profile Hydraulic Floor Jack

This jack features a safety overload system to prevent use beyond rated capacity. Rotating Heavy Duty Saddle and dual piston for quick lift pump. Meets ASME 2014 safety standards. Red powder coated finish.

PART#	CAPACITY	LIFTING RANGE
11559	6,000 lbs	2-15/16" to 19-11/16"



Jack Stands

Made of A3 steel. Meets ANSI 2009 Specs. Powder coated finish. Ratchet locking gear. Ideal for auto, home, and shop. 2 per box.

PART#	CAPACITY	ADJUSTABLE HEIGHTS	BASE DIMENSIONS
11548	6,600 lb/ea. stand	11-7/32" to 16-7/8"	7-5/8" x 6-7/8"
11549	13,200 lb/ea. stand	15-1/2" to 23-3/4"	10-13/16" x 9-5/8"
11550	26,400 lb /ea. stand	19-3/8" to 28-1/8"	11-1/2" x 12-5/8"



3 Ton Heavy Duty Jack Stand Double Locking.

Heavy duty steel, meets ASME 2014 safety standard. Features a double-lock protection and a large saddle surface area. Self locking, multi-position, forged iron ratcheted bar. Red powder coated finish. 2 Per box.

PART#	CAPACITY	LIFTING RANGE
11570	6,000 lbs	10-7/16" TO 16-3/4"



Hydraulic Bottle Jack

Made of dropped forged alloy steel and red powder coated finish. These jacks are designed for residential and commercial use. Features a serrated heat treated saddle and an adjustable screw top extension. Meets ASME 2014 safety standards.

PART#	CAPACITY	LIFTING RANGE	TON
11551	40,000 lbs	6-7/32" TO 12-1/8"	2 Ton
11552	80,000 lbs	7-3/32" to 13-3/4"	4 Ton
11553	12,000 lbs	7-3/4" to 15-3/64"	6 Ton
11554	24,000 lbs	5-1/8" TO 40"	12 Ton
11555	40,000 lbs	9-5/8" to 17-11/16"	20 Ton



20 Ton Pneumatic/Hydraulic Bottle Jack

Drop forged alloyed steel construction, red powder coated. Manual or air operation. Designed for heavy commercial use. 100 to 120 psi pressure rating. Serrated heat treated saddle. Adjustable screw top extension. Air valve with integrated filter, seal hydraulic unit. Meets ASME 2014 safety standards.

PART#	CAPACITY	LIFTING RANGE	TON
11556	40,000 lbs	10-7/32" to 20-3/32"	20 Ton



Utility Farm Jack

Made of heavy duty steel and a red powder coated finish. This jack can be used horizontally or vertically in any application requiring lifting, pulling, clamping, winching and spreading. Meets ASME B30.1 safety standard.

PART#	CAPACITY	LIFTING RANGE	SIZE
11572	70,000 lbs	5-1/8" TO 28-11/32"	36"
11573	80,000 lbs	5-1/8" TO 40"	48"



Utility Farm Jack Maintenance Kit - 11574

Universal farm jack maintenance kit for 11572 & 11573.

Sizes are approximate. Specifications subject to change without notice.





Tire Dolly

This dolly is made of durable polypropylene. It features non-marking thermoplastic swivel casters to make moving tires around the shop or garage much easier.

PART#	CAPACITY	SIZE
11388	300 lbs	26"X26"X4.3"



Tire Racking Dolly

This tire rack dolly will help to store and move tires around a shop effortlessly. Built with 4 swivel casters with one featuring a locking break mechanism to prevent it from rolling away. Built to prevent tire distortion, it features rim protecting supports to accommodate tires up to 8.8" wide.

PART#	CAPACITY	CAPACITY PER LEVEL
11389	220 lbs	55 lbs



Wall-Mount Folding Tire Rack

This red, wall-mounted tire rack will easily accommodate standard tires. It is made of heavy duty steel to ensure longevity.

PART#	CAPACITY	SIZE
11390	300 lbs	Adjustable width from 32" to 48", 22" long x 20"

Shop Towels

Bundle of 6 wrapped red towels. Each towel is 13" x 14".



PART#	COLOR	PIECES PER BUNDLE
51395	Red	6 Pieces

Low Profile Vehicle Ramp

Made of high impact plastic, rust proof and durable. 20,000 Lbs gross vehicle weight. 2 Per box.

PART#	DIMENSIONS	LIFT HEIGHT	INCLINE DEGREE	CAPACITY PER RAMP
11380	27.5" x 8" x 3.1"	2.5"	9	5,000 lbs



Stackable Vehicle Ramp

Curve cradle platform to keep the wheels in position. Non-skid tread pattern design - increases traction and reduces shifting. Made of high impact plastic, rust proof and durable. 16,000 Lbs gross vehicle weight. 2 Per box.

PART#	DIMENSIONS	LIFT HEIGHT	INCLINE DEGREE	CAPACITY PER RAMP
11381	35.6" x 13" x 8.5"	6.1"	17	4,000 lbs



Detachable Vehicle Ramp

Features a detachable incline design to accommodate for bigger working space or for adding a jack for extra safety. Made of high impact plastic, rust proof and durable. Comes with 6 rubber pads on each section for maximum grip. 13,000 Lbs gross vehicle weight. 2 Per box.

PART#	DIMENSIONS	LIFT HEIGHT	INCLINE DEGREE	CAPACITY PER RAMP
11382	52.6" x 15" x 8.3"	6.3"	9.5	3,250 lbs



Garage Parking Stops

Features a peel and stick design with Styrofoam film on the back. Easy to install, no need for drilling. Made of environmentally friendly material. Highly visible yellow safety stripes to improve visibility.

PART#	SIZE
11386	18" x 3.5" x 1.3"
11387	18" x 3.8" x 1.8"



Sizes are approximate. Specifications subject to change without notice.





SANITATION



H

Handheld Pressure Sprayer 328

Handheld Sprayer 328

S

Stainless Steel Industrial Sprayer 329





1L Handheld Sprayer

PART#	CONTENTS
40020	<ul style="list-style-type: none"> • Self-locking Switch • Polyethylene Tank with Graduated Markings on Side • Solid Brass Nozzle • Ergonomic Handle • 360° Spray Head Offers Jet Stream Spraying or Fine Misting Spraying Modes

2L Handheld Sprayer

PART#	CONTENTS
40021	<ul style="list-style-type: none"> • Self-locking Switch • Polyethylene Tank with Graduated Markings on Side • Solid Brass Nozzle • Ergonomic Handle • 360° Spray Head Offers Jet Stream Spraying or Fine Misting Spraying Modes



6L Handheld Pressure Sprayer

PART#	CONTENTS
40022	<ul style="list-style-type: none"> • General Purpose Pressure Sprayer • Fully Adjustable Nozzle and Trigger Lock • Features a Safety Valve • Polyethylene Tank with Graduated Markings on Side

8L Handheld Pressure Sprayer

PART#	CONTENTS
40023	<ul style="list-style-type: none"> • General Purpose Pressure Sprayer • Fully Adjustable Nozzle and Trigger Lock • Features a Safety Valve • Polyethylene Tank with Graduated Markings on Side

Replacement parts

For 6L Handheld Sprayer (40022) and 8L Handheld Sprayer (40023)

PART#	PRODUCT DESCRIPTION
40024	Replacement Seal Kit
40025	Replacement Trigger and Hose
40026	Replacement Lance

Sizes are approximate. Specifications subject to change without notice.



16L Stainless Steel Industrial Sprayer

PART#	CONTENTS
40028	<ul style="list-style-type: none"> Viton seal material, brass tip nozzle and stainless steel tank and wand Total Volume 20L/ Working Volume 16L Features 2 carry on straps for single and double shoulder 47" PVC Hose Max working pressure 4 PSI Comes with a pressure gauge 8.3" tank diameter/ 1.5" filling mouth diameter



Replacement parts

For 16L Stainless Steel Industrial Sprayer (40028)

PART#	PRODUCT DESCRIPTION
40028-1	Sprayer Seals Kit - Replacement for 40028
40028-2	Replacement Pressure Gauge - 40028
40028-3	Replacement Hose for 40028
40028-4	Replacement Spray Gun for 40028
40028-6	Replacement Wand for 40028



Sanitation



16L Stainless Steel Industrial Sprayer

PART#	CONTENTS
40028	<ul style="list-style-type: none"> Viton seal material, brass tip nozzle and stainless steel tank and wand Total Volume 20L/ Working Volume 16L Features 2 carry on straps for single and double shoulder 47" PVC Hose Max working pressure 4 PSI Comes with a pressure gauge 8.3" tank diameter/ 1.5" filling mouth diameter



Replacement parts

For 16L Stainless Steel Industrial Sprayer (40028)

PART#	PRODUCT DESCRIPTION
40028-1	Sprayer Seals Kit - Replacement for 40028
40028-2	Replacement Pressure Gauge - 40028
40028-3	Replacement Hose for 40028
40028-4	Replacement Spray Gun for 40028
40028-6	Replacement Wand for 40028



Sanitation

Sizes are approximate. Specifications subject to change without notice.

