

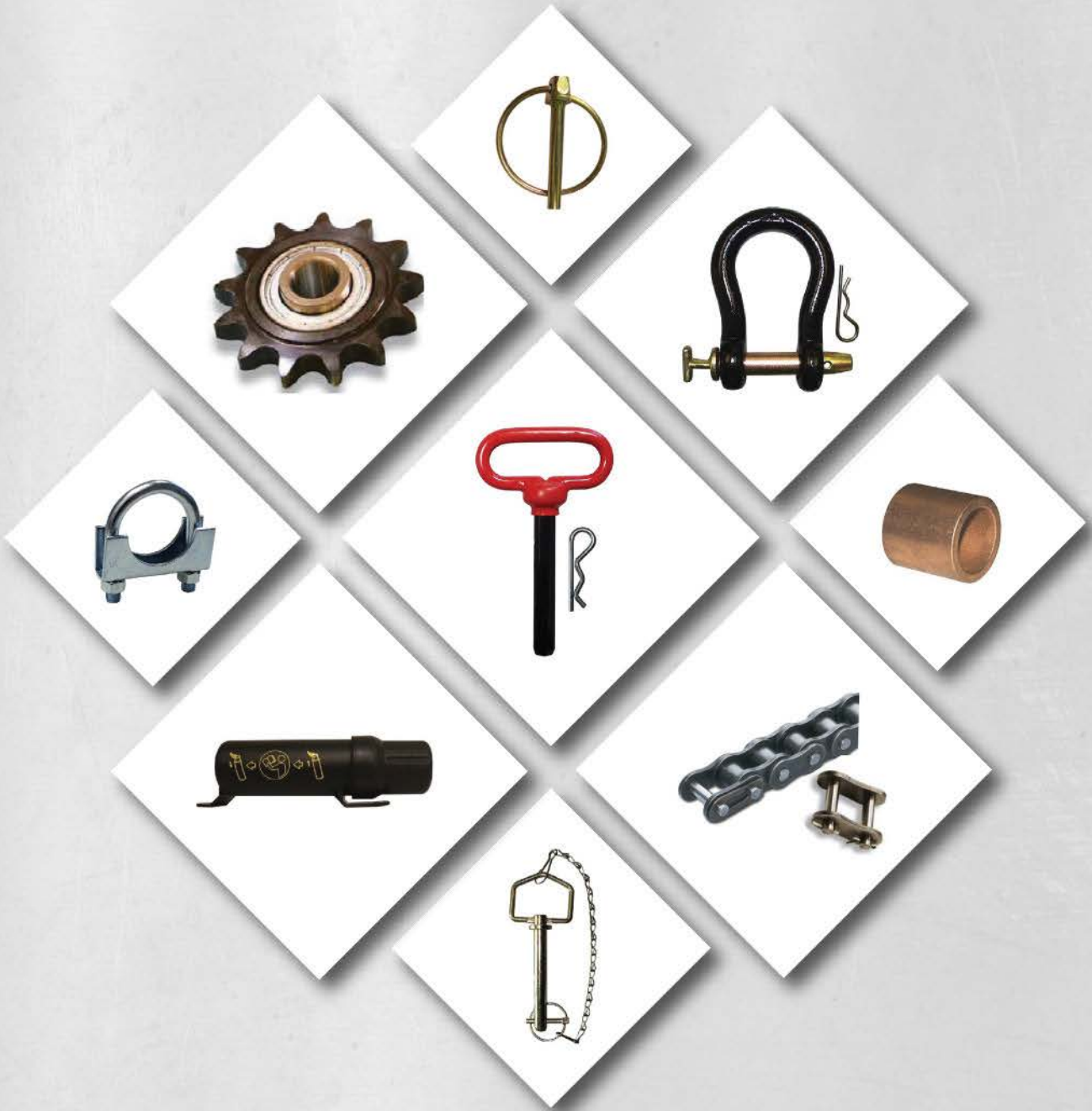

# FARM HARDWARE



<b>A</b>		Merchandiser - Tractor Linkage Parts	288
Aluminum Document Holder	314	Merchandiser - Weather Caps	288
<b>B</b>		Muffler Clamps	289
Barbed Wire Carrier	292	<b>O</b>	
Bronze Bushings	310	Offset Links	300
<b>C</b>		<b>P</b>	
Cast T-Post Puller	292	Plastic Document Holders	314
Connecting Links	300	Pulleys for A & B Belts	298
Cylinder Pins	301	Pulleys for C Belts	298
<b>D</b>		<b>R</b>	
Drawbars	311	Ratchet Jack	313
<b>F</b>		Roller Chain	299
Fence Post Pounders	291	Roller Chain Breakers	299
Flat Type Idler Pulleys	298	Round Quick Pins	308
Forged Steel Hitch Pins	306	Round Tab Type Quick Pins	308
<b>G</b>		<b>S</b>	
Gate Anchor	291	S/B Bushings	299
Gate Latches	291	Shaft Set Collars	301
Gate Wheels	291	Spring Lock Pins	307
<b>H</b>		Sprockets	293, 294, 295
Hair Pin Clips	309	Square Quick Pins	308
High Strength Hitch Pins	305	Stabilizer Pins	313
Hinge Bolts	290	Steering Wheel Spinners	303
Hinge Clamps	290	Straight Clevises	302
Hinge Straps	290	Stroke Control Segment Kits	301
Hitch Pin - Round Ring Grip	303	<b>T</b>	
Hitch Pins - E-Grip	305	T-Handle Clevis Pins	302
Hitch Pins - Fold Over Handle	304	Top Link Bushings	311
<b>I</b>		Top Link Pins	313
Idler Hubs	297	Top Link Repair Ends	312
Idler Sprockets	295	Tractor Drawbar Hook	302
Industrial Safety Pins	303	Twist Clip Pins	309
<b>L</b>		Twisted Clevises	302
Lad Screw Hinge Bolts	290	<b>U</b>	
Lift Arm Bushings	311	Universal Tail Pipe Hanger	289
Linch Pins	307	<b>V</b>	
Locking Hitch Pins	306	V-Series Hubs	296
<b>M</b>		V-Type Idler Pulleys	298
Merchandiser - Bronze Bushings	287	<b>W</b>	
Merchandiser - Farm Hardware	287	Weather Caps	289
Merchandiser - Farm Hardware Bulk Racks	288	Wire Gripper	292
Merchandiser - Farm Packs	288	Wire Ring Quick Release Pins	303
Merchandiser - Grade 8 Hitch Pins	287	Wire Stretcher	292
Merchandiser - Hitch Pins	287	W-Series Hubs	296, 297
Merchandiser - Muffler Clamps	287	<b>X</b>	
Merchandiser - Pins	287	X-Series Hubs	297
Merchandiser - Stroke Control	288		





Your Trusted Source.

## Dynaline Farm Hardware Merchandisers

Dynaline offers merchandisers for almost every product. Merchandisers keep your stock organized, visible and easy to shop.



Farm Hardware



**Pins Merchandiser**



PART#	CONTENTS
00557	Pins <b>Display Board Only</b> , 24" x 24"
00557K	<b>Full Pins Merchandiser.</b> Includes 00557 display board, 53 pegs (80004) and the products.

**i** Full product breakdown on page 56



**Farm Hardware Merchandiser**



PART#	CONTENTS
01101	Farm Hardware <b>Backdrop Only</b> , 48" x 48"
01101K	<b>Full Farm Hardware Plan-o-gram.</b> Includes 01101 and the products.

**i** Full product breakdown on page 57



**Grade 8 Hitch Pins Merchandiser**



PART#	CONTENTS
00439	Grade 8 Hitch Pins <b>Display Board Only</b> , 24" x 24"
00439K	<b>Full Grade 8 Hitch Pins Merchandiser.</b> Includes 00439 display board, 22 pegs (80004) and the products.

**i** Full product breakdown on page 58

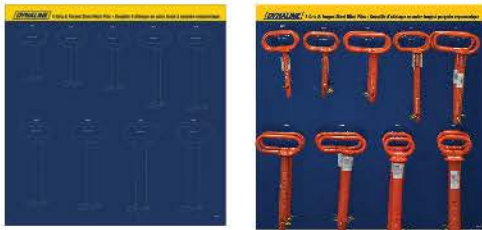

**E-Grip & Forged Steel Hitch Pins Merchandiser**



PART#	CONTENTS
00441	E-Grip & Forged Steel Hitch Pins <b>Display Board Only</b> , 24" x 24"
00441K	<b>Full E-Grip &amp; Forged Steel Hitch Pins Merchandiser.</b> Includes 00441 display board, 22 pegs (80004) and the products.

**i** Full product breakdown on page 58



**Hitch Pins Merchandiser**



PART#	CONTENTS
00435	Hitch Pins <b>Display Board Only</b> , 24" x 24"
00435K	<b>Full Hitch Pins Merchandiser.</b> Includes 00435 display board, 23 pegs (80004) and the products.

**i** Full product breakdown on page 59

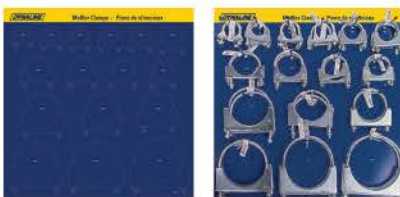

**Muffler Clamps Merchandiser**



PART#	CONTENTS
00307	Muffler Clamps <b>Display Board Only</b> , 24" x 24"
00307K	<b>Full Muffler Clamps Merchandiser.</b> Includes 00307 display board, 16 pegs (80004) and the products.

**i** Full product breakdown on page 45



**Bronze Bushings Merchandiser**

PART#	CONTENTS
00325	Bronze Bushings <b>Display Board Only</b> , 12" x 24"
00325K	<b>Full Bronze Bushings Merchandiser.</b> Includes 00325 display board, 51 pegs (80004) and products.

**i** Full product breakdown on page 45



Sizes are approximate. Specifications subject to change without notice.



## Hitch Pins (Fold Over Handle with Chain) Merchandiser

PART#	CONTENTS
-------	----------

**00436** Hitch Pins (FOH) **Display Board Only**, 24" x 24"

**00436K** "Fold Over Handle" Full Hitch Pins Merchandiser. Includes 00436 display board, 9 pegs (80004) and the products.



00024 Compatible

Full product breakdown on page 59



00024 Compatible

## Tractor Linkage Parts Merchandiser

00024 Compatible

PART#	CONTENTS
-------	----------

**00438** Tractor Linkage **Display Board Only**, 12" x 24"

**00438K** Full Tractor Linkage Parts Merchandiser. Includes 00438 display board, 26 pegs (80004) and the products.

Full product breakdown on page 60

## Stroke Control Merchandiser

00024 Compatible

PART#	CONTENTS
-------	----------

**00297** Stroke Control **Display Board Only**, 12" x 24"

**00297K** Full Stroke Control Merchandiser. Includes 00297 display board, 17 pegs (80004) and the products.

Full product breakdown on page 60

## Weather Caps Merchandiser

PART#	CONTENTS
-------	----------

**00226** Weather Caps **Display Board Only**, 24" x 24"

**00226K** Full Weather Caps Merchandiser. Includes 00226 display board, 26 pegs (80004) and the products.

Full product breakdown on page 61

## Farm Packs Merchandiser

PART#	CONTENTS
-------	----------

**00620** Farm Packs **Display Board Only**, 24" x 24"

**00620K** Full Farm Packs Merchandiser. Includes 00620 display board, 37 pegs (80004) and the products.

Full product breakdown on page 61



## Farm Hardware Bulk Merchandiser

00024 Compatible

PART#	CONTENTS
-------	----------

**00028** Bulk Display Rack Only - 72" x 32" x 24" - 7 shelves

**00032K** Full Merchandiser. 152 part #'s, 826 pieces. Includes: 4 sign headers, bulk bin interlocking displays, bin labels and the products listed below:

Full product breakdown on page 8

## Farm Hardware / Chain and Rigging Bulk Merchandiser

PART#	CONTENTS
-------	----------

**00028** Bulk Display Rack Only - 72" x 32" x 24" - 7 shelves

**00036K** Full Merchandiser. 164 part #'s, 864 pieces. Includes: 4 sign headers, bulk bin interlocking displays, bin labels and the products listed below:

Full product breakdown on page 12



Sizes are approximate. Specifications subject to change without notice.

Farm Hardware

## Weather Caps

Clear zinc plated steel. Single bolt installation, silencer block, heat resistant rivets and bushings.

PART#	FITS PIPE DIAMETER	PART#	FITS PIPE DIAMETER
<input type="checkbox"/> 11200	1-1/2" – 1-11/16"	<input type="checkbox"/> 11206	3" – 3-3/16"
<input type="checkbox"/> 11201	1-3/4" – 1-15/16"	<input type="checkbox"/> 11207	3-1/2" – 3-11/16"
<input type="checkbox"/> 11202	2" – 2-3/16"	<input type="checkbox"/> 11208	4" – 4-3/16"
<input type="checkbox"/> 11203	2-1/4" – 2-7/16"	<input type="checkbox"/> 11209	4-1/2" – 4-11/16"
<input type="checkbox"/> 11204	2-1/2" – 2-11/16"	<input type="checkbox"/> 11210	5" – 5-1/4"
<input type="checkbox"/> 11205	2-3/4" – 2-15/16"		



## Universal Tail Pipe Hanger

PART#	DESCRIPTION
11220	Open end design for use with assembled clamps.



## Muffler Clamps

Clear zinc plated. 3/8" (8.3 mm) wire diameter. Material: Q235 Steel.

PART#	SIZE	PART#	SIZE	PART#	SIZE
11225	1-1/2"	11231	2-1/4"	11236	4"
11226	1-5/8"	11232	2-1/2"	11237	4-1/2"
11227	1-3/4"	11233	2-3/4"	11238	5"
11228	1-7/8"	11234	3"	11239	5-1/2"
11229	2"	11235	3-1/2"	11240	6"
11230	2-1/8"			11241	3-1/4"



Your Trusted Source.



### Muffler Clamps

- Creates seal and prevents component separation by partially deforming pipe. To create a 360 degree mechanical seal, use two traditional saddle clamps at opposing directions on the connection.

Sizes are approximate. Specifications subject to change without notice.

Legend:  12x24  24x24  Plan-O-Gram  Rack/End Cap  Other



Farm Hardware





## Hinge Straps

Hinge straps for use with 3/8" carriage bolts.

PART#	SIZE	HINGE HOLE DIAMETER
102530	6"	1/2"
102531	8"	1/2"
102532	10"	5/8"
102533	12"	5/8"
102534	14"	3/4"
102535	16"	3/4"



## Hinge Clamps

PART#	SIZE	HINGE HOLE DIAMETER
102536	3/4" x 1-3/4"	3/4"
102537	3/4" x 2"	3/4"
102538	5/8" x 1-3/4"	5/8"
102539	5/8" x 2"	5/8"



## Hinge Bolts

PART#	SIZE	STRAP SIZE
102540	1/2" x 6"	6" & 8"
102541	5/8" x 8"	10" & 12"
102542	5/8" x 12"	10" & 12"
102543	3/4" x 10"	14" & 16"
102544	3/4" x 12"	14" & 16"



## Lad Screw Hinge Bolts

PART#	DESCRIPTION	SIZE	STRAP SIZE
102545	Male	1/2" x 4"	6" & 8"
102546	Male	5/8" x 5"	10" & 12"
102547	Male	3/4" x 6"	14" & 16"
102548	Female, with eye hinge	1/2" x 4"	6" & 8"
102549	Female, with eye hinge	5/8" x 5"	10" & 12"

Sizes are approximate. Specifications subject to change without notice.



## Gate Anchor

PART#	DESCRIPTION	OUTSIDE DIAMETER
102554	Gate anchor holds gate open in any position for round tube gates	1-3/4" - 2"



## Gate Wheels

PART#	DESCRIPTION
102555	Gate wheels permit easy opening of fence gates and prevent sagging of gate, for tube gates with outside dimensions between 1-5/8" and 2". 8" wheel
102556	"Spring wheel gate adjusts for high ground clearance, prevents sagging of gate, for tube gates with outside dimensions between 1-5/8" and 2". Includes hardware for installation. 10" wheel
102557	Tall gate wheels for high ground clearance, prevents sagging of gate, for tube gates with outside dimensions between 1-5/8" and 2". Includes hardware for installation. 8" wheel



## Gate Latches

PART#	DESCRIPTION
102550	2-Way gate latch, for round tube gates 1-5/8" to 2" outside diameter
102551	2-Way gate latch, lockable, accepts padlock, for round tube gates 1-1/4" to 1-1/2" outside diameter
102553	"1-Way gate latch, lockable, accepts padlock, for round tube gates 1-5/8" to 2" outside diameter

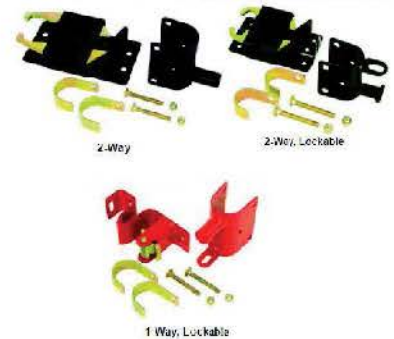

## Fence Post Pounders

Drives steel posts into the ground quickly.

PART#	Type	Weight	Length	Inner Dia.	Wall Thickness
102564	Standard duty	12 Lbs.	23 1/4"	2.7"	0.15"
102565	Medium duty	16 Lbs.	31"	2.07"	0.15"
102566	Heavy duty	30 Lbs.	27 1/4"	3.08"	0.23"



12 lb Standard Duty



16 lb Standard Duty



30 lb Standard Duty

Sizes are approximate. Specifications subject to change without notice.





## Barbed Wire Carrier

Free spinning design provides safe way to carry and unroll barbed wire by one individual.

PART#	DESCRIPTION
102562	Free spinning design provides safe way to carry and unroll barbed wire by one individual.



## Wire Gripper

Wire gripper holds wire in place for fencing maintenance, works with barbed and smooth wire and small diameter cable.

PART#	DESCRIPTION
102563	Wire gripper holds wire in place for fencing maintenance, works with barbed and smooth wire and small diameter cable.



PART#	DESCRIPTION
102568	Metal T-post puller with innovative slot that permits use with different gauges of chain. Use with tractor bucket, chain, handyman jack or s-hook.



With Ratchet Control

## Wire Stretcher

PART#	DESCRIPTION
102571	Wire stretcher with ratchet control, for release of wire tension.

Sizes are approximate. Specifications subject to change without notice.





**Sprockets for #40 Chain - 1/2" Pitch**

PART#	"NUMBER OF TEETH"	OUTSIDE DIAMETER	USE HUB SERIES
102575	12	2-3/16"	V
102576	13	2-1/4"	V
102577	14	2-7/16"	V
102578	15	2-5/8"	V
102579	16	2-13/16"	W
102580	17	3"	W
102581	18	3-1/8"	W
102582	19	3-5/16"	W
102583	20	3-7/16"	X
102584	21	3-5/8"	X
102585	22	3-3/4"	X
102586	23	4"	X
102587	24	4-1/16"	X
102588	26	4-3/8"	X
102589	28	4-11/16"	X
102590	30	5-1/16"	X
102591	32	5-3/8"	X
102592	36	6"	X
102593	40	6-5/8"	X
102594	42	7"	X
102595	45	7-3/8"	X
102596	48	7-7/8"	X
102597	60	9-13/16"	X



**Sprockets for #50 Chain - 5/8" Pitch**

PART#	"NUMBER OF TEETH"	OUTSIDE DIAMETER	USE HUB SERIES
102598	10	2-1/4"	V
102599	11	2-1/2"	V
102600	12	2-3/4"	W
102601	13	2-7/8"	W
102602	14	3-1/16"	W
102603	15	3-1/4"	W
102604	16	3-7/16"	W
102605	17	3-11/16"	X
102606	18	3-7/8"	X
102607	19	4-1/8"	X
102608	20	4-3/8"	X
102609	21	4-9/16"	X
102610	22	4-3/4"	X
102611	24	5-1/8"	X
102612	26	5-1/2"	X
102613	28	5-7/8"	X



Sizes are approximate. Specifications subject to change without notice.





### Sprockets for #50 Chain - 5/8" Pitch - Continuation

PART#	"NUMBER OF TEETH"	OUTSIDE DIAMETER	USE HUB SERIES
102614	30	6-5/16	X
102615	32	6-3/4"	X
102616	34	7-1/16"	X
102617	36	7-9/16"	X
102618	40	8-5/16"	X
102619	42	8-11/16"	X
102620	50	10-1/4"	X
102621	60	12-5/16"	X
102622	96	19-7/16"	X



### Sprockets for #60 Chain - 3/4" Pitch

PART#	"NUMBER OF TEETH"	OUTSIDE DIAMETER	USE HUB SERIES
102623	9	2-1/2"	V
102624	10	2-3/4"	V
102625	11	3"	W
102626	12	3-1/4"	W
102627	13	3-1/2"	W
102628	14	3-3/4"	W
102629	15	4"	X
102630	16	4-1/4"	X
102631	17	4-1/2"	X
102632	18	4-11/16"	X
102633	19	5"	X
102634	20	5-1/8"	X
102635	21	5-1/2"	X
102636	22	5-11/16"	X
102637	24	6-1/8"	X
102638	26	6-5/8"	X
102639	28	7-1/8"	X
102640	30	7-5/8"	X
102641	32	8"	X
102642	36	9"	X
102643	40	9-15/16"	X
102644	42	10-1/2"	X
102645	54	13-1/4"	X

Sizes are approximate. Specifications subject to change without notice.



## Sprockets for #80 Chain - 1" Pitch

PART#	"NUMBER OF TEETH"	OUTSIDE DIAMETER	USE HUB SERIES
102870	9	3-11/32"	W
102871	10	3-11/16"	W
102872	11	4"	W
102873	12	4-11/32"	X
102874	13	4-21/32"	X
102875	14	4-31/32"	X
102876	15	5-9/32"	X
102877	16	5-5/8"	X
102878	17	5-31/32"	X
102879	18	6-9/32"	X
102880	19	6-19/32"	X
102881	20	6-29/32"	X
102882	21	7-7/32"	X
102883	22	7-9/16"	X
102884	23	7-7/8"	X
102885	24	8-7/32"	X
102886	25	8-17/32"	X
102887	30	10-3/32"	X



## Idler Sprockets

PART#	CHAIN SIZE	"NUMBER OF TEETH"	BORE SIZE
102646	40 or 41	17	1/2"
102647	40 or 41	17	5/8"
102648	50	13	1/2"
102649	50	13	5/8"
102650	50	15	1/2"
102651	50	15	5/8"
102652	50	17	1/2"
102653	50	17	5/8"
102654	60	11	1/2"
102655	60	11	5/8"
102656	60	13	1/2"
102657	60	13	5/8"
102658	60	15	1/2"
102659	60	15	5/8"



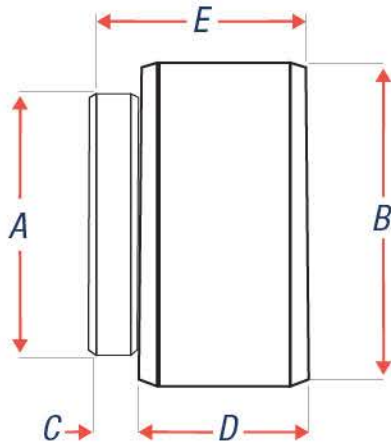

	A	B	C	D	E
V-Series Hubs to fit V-Type Sprocket	1-1/8"	1-7/16"	7/16"	3/4"	1-3/16"
W-Series Hubs to fit W-Type Sprocket	1-5/8"	1-13/16"	7/16"	1"	1-7/16"
X-Series Hubs to fit W-Type Sprocket	2"	2-1/2"	7/16"	1"	1-7/16"



### V-Series Hubs (Round Bore)

Round Bore with Keyway and Set Screw

PART#	BORE SIZE
102660	1/2"
102661	5/8"
102662	3/4"
102663	7/8"



### W-Series Hubs (Round Bore)

Round Bore with Keyway and Set Screw

PART#	BORE SIZE
102664	1/2"
102665	9/16"
102666	5/8"
102667	11/16"
102668	3/4"
102669	13/16"
102670	7/8"
102671	15/16"
102672	1"
102673	1-1/16"
102674	1-1/8"
102675	1-3/16"
102676	1-1/4"



### W-Series Hubs (Hexagon Bore)

Hexagon Bore with Set Screw

PART#	BORE SIZE
102677	7/8"
102678	1"

Sizes are approximate. Specifications subject to change without notice.



**W-Series Hubs (Spline Bore)**

Spline Bore with Set Screw

PART#	BORE SIZE
102679	1-1/8" x 6
102680	1-3/8" x 6

**X-Series Hubs (Round Bore)**

Round Bore with Keyway and Set Screw

PART#	BORE SIZE
102681	5/8"
102682	11/16"
102683	3/4"
102684	13/16"
102685	7/8"
102686	15/16"
102687	1"
102688	1-1/16"
102689	1-1/8"
102690	1-3/16"
102691	1-1/4"
102692	1-5/16"
102693	1-3/8"
102694	1-7/16"
102695	1-1/2"

**X-Series Hubs (Hexagon Bore)**

Hexagon Bore with Set Screw

PART#	BORE SIZE
102696	7/8"
102697	1"
102698	1-1/8"

**X-Series Hubs (Spline Bore)**

Spline Bore with Set Screw

PART#	BORE SIZE
102699	1-1/8" x 6
102700	1-3/8" x 6

**Idler Hubs**

PART#	HUB SERIES	BORE SIZE
102701	W	5/8" & 1/2"
102702	X	5/8" & 1/2"



Sizes are approximate. Specifications subject to change without notice.



### Pulleys for A & B Belts

PART#	OUTSIDE DIAMETER	FITS HUB SERIES	FITS V-BELT STYLE
102703	2-1/2"	V	A or B
102704	3"	V	A or B
102705	3-1/2"	W	A or B
102706	4"	W	A or B
102707	4-1/2"	W	A or B
102708	5"	W	A or B
102709	5-1/2"	W	A or B
102710	6"	W	A or B
102711	6-1/2"	W	A or B
102712	7"	W	A or B
102713	8"	W	A or B
102714	9"	W	A or B
102715	10"	W	A or B
102716	11"	W	A or B
102717	12"	W	A or B
102718	14"	W	A or B
102719	16"	W	A or B



### Pulleys for C Belts

PART#	OUTSIDE DIAMETER	FITS HUB SERIES	FITS V-BELT STYLE
102720	6"	X	C
102721	8"	X	C
102722	10"	X	C
102723	12"	X	C



### Flat Type Idler Pulleys

PART#	OUTSIDE DIAMETER	BORE SIZE	FLAT BORE WIDTH
102724	1-7/8"	3/8"	3/4"
102725	2-1/4"	3/8"	1"
102726	2-3/4"	5/8"	7/8"
102727	3-1/4"	5/8"	3/4"
102728	3-1/2"	5/8"	1"
102729	4"	5/8"	3/4"
102730	4"	1/2"	1"



### V-Type Idler Pulleys

PART#	OUTSIDE DIAMETER	BORE SIZE	GROOVE WIDTH	BELT SIZES
102732	2-1/2"	3/8"	1/2"	4L, 3L, 3V
102733	3"	5/8"	5/8"	5L, 4L, 5V
102734	3-1/2"	5/8"	5/8"	5L, 4L
102735	4"	5/8"	5/8"	5L, 4L
102736	4-1/2"	5/8"	5/8"	5L, 4L
102737	5"	5/8"	5/8"	5L, 4L



Sizes are approximate. Specifications subject to change without notice.



### S/B Bushings with and without hubs for idler pulleys

PART#	INNER DIAMETER	SHOULDER LENGTH	OVERALL LENGTH	OUTER DIAMETER
102738	3/8"	0.0	0.4	5/8"
102739	3/8"	0.4	0.8	5/8"
102740	1/2"	0.0	0.4	5/8"
102741	1/2"	0.4	0.8	5/8"



102739, 102741



102738, 102740

### Roller Chain

High-quality roller chain that meets or exceeds ANSI standards. Pre-stretched, solid rollers with welded bushings to maximize durability.

PART#	CHAIN NUMBER	UNIT (FT.)	PITCH
102742	35	10	3/8"
102743	35	50	3/8"
102744	35-2	10	3/8"
102745	41	10	1/2"
102746	41	50	1/2"
102747	40	10	1/2"
102748	40	50	1/2"
102749	50	10	5/8"
102750	50	50	5/8"
102751	50-2	10	5/8"
102752	50-H	10	5/8"
102753	60	10	3/4"
102754	60	50	3/4"
102755	60-2	10	3/4"
102756	60-H	10	3/4"
102757	80	10	1"
102758	80	50	1"
102759	80-2	10	1"
102760	80-H	10	1"
102761	100	10	1-1/4"
102762	120	10	1-1/2"
102763	A2040	10	1"
102764	A2040	50	1"
102765	A2050	10	1-1/4"
102766	A2050	50	1-1/4"
102767	A2060	10	1-1/2"



### Roller Chain Breakers

PART#	DESCRIPTION	FITS
102768	Roller chain breaker	#25 to #60 chain
102769	Roller chain breaker	#60 to #100 chain
102770	Replacement tip assembly	For breaker #102768
102771	Replacement tip assembly	For breaker #102769



Sizes are approximate. Specifications subject to change without notice.





Farm Hardware



### Connecting Links

PART#	CHAIN NUMBER	QUANTITY	PITCH
102772	35	4	3/8"
102773	35-2	4	3/8"
102774	41	4	1/2"
102775	40	4	1/2"
102776	50	4	5/8"
102777	50-2	4	5/8"
102778	50-H	4	5/8"
102779	60	3	3/4"
102780	60-2	3	3/4"
102781	60-H	3	3/4"
102782	80	2	1"
102783	80-2	2	1"
102784	80-H	2	1"
102785	100	2	1-1/4"
102786	120	2	1-1/2"
102787	A2040	4	1"
102788	A2050	3	1-1/4"
102789	A2060	3	1-1/4"

### Offset Links

PART#	CHAIN NUMBER	QUANTITY	PITCH
102790	35	4	3/8"
102791	35-2	4	3/8"
102792	41	4	1/2"
102793	40	4	1/2"
102794	50	4	5/8"
102795	50-2	4	5/8"
102796	50-H	4	5/8"
102797	60	3	3/4"
102798	60-2	3	3/4"
102799	60-H	3	3/4"
102800	80	2	1"
102801	80-2	2	1"
102802	80-H	2	1"
102803	100	2	1-1/4"
102804	120	2	1-1/2"
102805	A2040	4	1"
102806	A2050	3	1-1/4"
102807	A2060	3	1-1/4"



Sizes are approximate. Specifications subject to change without notice.



## Stroke Control Segment Kits

For air & hydraulic cylinders. Cast aluminum alloy.

PART#	FITS SHAFT DIAMETER	SPACER WIDTH (1 EACH)	PACKAGING
102373	7/8" & 1-1/16"	3/4", 1", 1-1/4", 1-1/2"	Clamshell
102375	1-3/4", 1-7/8" & 2"	1", 1-1/2", 2", 4"	Clamshell
55000	1-1/8" to 1-1/4"	3/4", 1", 1-1/4" & 1-1/2"	Clamshell
55001	1-3/8" to 1-1/2"	3/4", 1", 1-1/4" & 1-1/2"	Clamshell
55002	2"	1", 1-1/2", 2", 4-1/4"	Polybag



## Stroke Control Segments

PART#	FITS SHAFT DIAMETER	WIDTH	PART#	FITS SHAFT DIAMETER	WIDTH
□ 55003	1-1/8" - 1-1/4"	3/4"	□ 55009	1-3/8" - 1-1/2"	1-1/4"
□ 55004	1-1/8" - 1-1/4"	1"	□ 55010	1-3/8" - 1-1/2"	1-1/2"
□ 55005	1-1/8" - 1-1/4"	1-1/4"	□ 55011	2"	1"
□ 55006	1-1/8" - 1-1/4"	1-1/2"	□ 55012	2"	1-1/2"
□ 55007	1-3/8" - 1-1/2"	3/4"	□ 55013	2"	2"
□ 55008	1-3/8" - 1-1/2"	1"	□ 55014	2"	4-1/4"

## Cylinder Pins

For air & hydraulic cylinders. Supplied with clips. S.A.E. 1018-1020 carbon steel hot rolled formed. Includes #66311 Hair Pin.

PART#	PIN DIAMETER	USABLE LENGTH
□ 55030	1"	2-3/4"
□ 55031	1"	3"



## Shaft Set Collars

Precision machined shaft set collars for exact fit, size stamped on collar, allen head screw included, yellow zinc dichromate plated.

PART#	INSIDE DIAMETER	OUTSIDE DIAMETER	WIDTH	SET SCREW SIZE
102397	1/4"	1/2"	9/32"	10-32x1/8"
102398	5/16"	5/8"	11/32"	10-32x1/8"
102399	3/8"	3/4"	3/8"	1/4-20x3/16"
102400	7/16"	7/8"	7/16"	1/4-20x1/4"
102401	1/2"	1"	1/2"	1/4-20x1/4"
102402	5/8"	1-1/8"	9/16"	5/16-18x1/4"
102403	11/16"	1-3/8"	5/8"	5/16-18x1/4"
102404	3/4"	1-3/8"	5/8"	5/16-18x1/4"
102405	7/8"	1-1/2"	5/8"	5/16-18x5/16"
102406	1"	1-5/8"	5/8"	5/16-18x5/16"
102407	1-1/8"	1-3/4"	5/8"	5/16-18x5/16"
102408	15/16"	1-5/8"	5/8"	5/16-18x5/16"
102409	1-1/4"	2"	11/16"	3/8-16x3/8"
102410	1-3/8"	2-1/8"	3/4"	3/8-16x3/8"
102411	1-1/2"	2-1/4"	3/4"	3/8-16x3/8"
102412	1-3/4"	2-3/4"	7/8"	1/2-13x1/2"
102413	1-7/8"	2-3/4"	7/8"	1/2-13x1/2"
102414	2"	3"	7/8"	1/2-13x1/2"



Sizes are approximate. Specifications subject to change without notice.



Farm Hardware



## Tractor Drawbar Hook

Forged steel. Black enamel painted body & zinc plated T-Pin. Supplied with #66305 Hair Pin.

PART#	CHAIN	A	PIN DIAMETER	PIN LENGTH	OVERALL LENGTH	W.L.L.
<b>66040</b>	5/16"-1/2"	1-5/8"	3/4"	3"	7"	9,200 lb
<b>102524</b>	Grab hook pin to fit Part #66040, 3/4" diameter, 2-1/2" usable length					

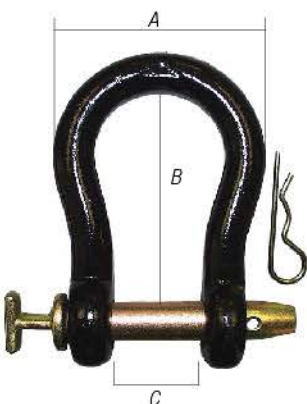

## Straight Clevises

Forged steel. Black enamel painted body & zinc plated T-Pin. Supplied with Hair Pin.

PART#	BODY DIAMETER	PIN DIAMETER	A	B	C	W.L.L.	U.L.L.
<b>66029</b>	5/8"	1/2"	3-1/4"	2"	7/8"	6,000 lb	18,000 lb
<b>66030</b>	3/4"	5/8"	3-3/4"	2-1/4"	1-5/16"	12,000 lb	36,000 lb
<b>66031</b>	7/8"	3/4"	4-1/4"	2-3/4"	1-5/16"	16,000 lb	48,000 lb
<b>66032</b>	15/16"	7/8"	4-5/8"	3-1/8"	1-7/16"	20,000 lb	60,000 lb
<b>66033</b>	1"	1"	5-5/16"	3-5/16"	2-1/8"	25,000 lb	75,000 lb



## Twisted Clevises

PART#	BODY DIAMETER	CLEVIS OPENING	USABLE LENGTH	PIN DIAMETER	W.L.L.
<b>102496</b>	3/4"	1-5/16"	3-1/2"	5/8"	12,000 lb
<b>102497</b>	7/8"	1-5/16"	3"	3/4"	16,000 lb
<b>102498</b>	7/8"	1-5/16"	3-7/8"	3/4"	16,000 lb
<b>102499</b>	15/16"	1-7/16"	4-1/4"	7/8"	20,000 lb
<b>102500</b>	1"	2-1/8"	5"	1"	25,000 lb



## T-Handle Clevis Pins

PART#	PIN DIAMETER	USABLE LENGTH	WEIGHT (LBS.)
<b>102525</b>	1/2"	2-1/4"	0.4
<b>102526</b>	5/8"	3-1/8"	0.5
<b>102527</b>	3/4"	3-1/4"	0.7
<b>102528</b>	7/8"	3-3/4"	1.2
<b>102529</b>	1"	4-1/4"	1.5

Sizes are approximate. Specifications subject to change without notice.



### Steering Wheel Spinners

Vinyl coated aluminum knob with chrome plated base. Ball bearing insert for long life. Safe and easy for use with most off-road vehicles.  
**Not for highway use.**

PART#	COLOR	QUANTITY
28327	Red	12 pieces per display box
28329	Black	12 pieces per display box



### Industrial Safety Pins

Oil tempered steel. Clear zinc plated finish.

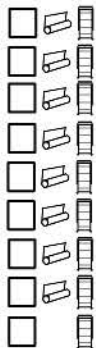

PART#	WIRE	A	B	PACKAGE QUANTITY
66470	1/8"	3-1/8"	1-1/16"	10
66472	3/16"	3-3/8"	1-1/2"	5
66474	1/4"	5-1/4"	1-3/4"	5
66489	3/32"	1-11/16"	5/8"	10
66490	1/8"	2-13/16"	13/16"	10
66491	3/16"	3"	1-1/2"	5
66492	5/32"	3-3/4"	1-1/8"	5
66493	15/64"	5"	1-5/8"	5
66494	15/64"	5"	2-1/4"	5



### Wire Ring Quick Release Pins

Spring-loaded ball locks pin into place. C-1010 zinc plated carbon steel pin (detent pin).

PART#	A	B	PACKAGE QUANTITY	PART#	A	B	PACKAGE QUANTITY
102316	3/16"	1"	1	66515	3/8"	1-1/2"	5
102317	3/16"	1-1/2"	1	66516	3/8"	2"	5
102318	3/16"	2"	1	66518	3/8"	2-1/2"	5
66499	1/4"	1"	5	66519	3/8"	3"	5
66500	1/4"	1-1/2"	5	102333	3/8"	4"	5
66501	1/4"	2"	5	102334	7/16"	2"	5
66503	1/4"	2-1/2"	5	102335	7/16"	3"	5
66505	1/4"	3"	5	66520	3/8"	3-1/2"	5
66507	5/16"	1"	5	66524	1/2"	1"	5
66508	5/16"	1-1/2"	5	66525	1/2"	1-1/2"	5
66509	5/16"	2"	5	66526	1/2"	2"	5
66510	5/16"	2-1/2"	5	66527	1/2"	2-1/2"	5
66511	5/16"	3"	5	66528	1/2"	3"	5
66514	3/8"	1"	5	66530	1/2"	3-1/2"	5

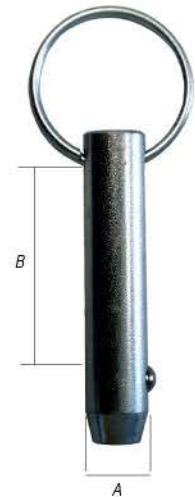

### Hitch Pin - Round Ring Grip

S.A.E.1020 high strength stress-proof steel. Clear zinc plated finish. Supplied with hair pin clip.

PART#	PIN DIAMETER (A)	USABLE LENGTH (B)	MIN. BREAK LOAD	HAIR PIN CLIP
66250	3/8"	3"	10,521 lbs	66301



Farm Hardware



Sizes are approximate. Specifications subject to change without notice.

Legend: □ 12x24 □ 24x24 ▢ Plan-O-Gram ▤ Rack/End Cap ○○○ Other

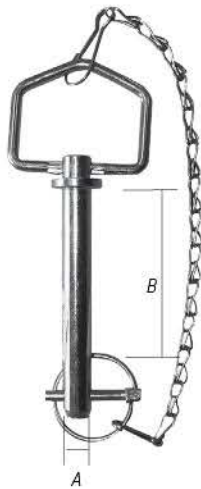

### Hitch Pins - Fold Over Handle With Chain

SAE 1045 stress-proof steel. Yellow zinc dichromate plated finish. Supplied with 66451 lynch pin & tenso chain.

PART#	PIN DIAMETER (A)	USABLE LENGTH (B)	MIN. BREAK LOAD	STEEL TYPE (SAE)	STEEL GRADE
<b>66280</b>	1/2"	4-1/4"	20,100 lb	1045	EN-8
<b>102187</b>	1/2"	6-1/4"	20,100 lb	1045	EN-8
<b>66281</b>	5/8"	4-1/4"	28,400 lb	1045	EN-8
<b>66282</b>	5/8"	6-1/4"	28,400 lb	1045	EN-8
<b>66283</b>	3/4"	4-1/4"	40,000 lb	1045	EN-8
<b>66284</b>	3/4"	6-1/4"	40,000 lb	1045	EN-8
<b>66285</b>	7/8"	6-1/4"	58,364 lb	1045	EN-8
<b>66286</b>	1"	6-1/4"	81,170 lb	1045	EN-8
<b>66287</b>	1-1/8"	6-1/4"	88,930 lb	1045	EN-8
<b>66288</b>	1-1/4"	6-1/4"	124,198 lb	1045	EN-8

### Hitch Pins - Fold Over Handle

SAE 1045 stress-proof steel. Yellow zinc dichromate plated finish. Supplied with hair pin.

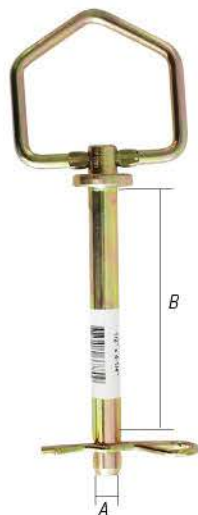







PART#	PIN DIAMETER (A)	USABLE LENGTH (B)	MIN. BREAK LOAD	HAIR PIN CLIP #	STEEL TYPE (SAE)	STEEL GRADE
<b>102171</b>	3/8"	4-1/4"	--	66303	1045	EN-8
<b>66780</b>	1/2"	4-1/4"	20,100 lb	66303	1045	EN-8
<b>102173</b>	1/2"	6-1/4"	20,100 lb	66303	1045	EN-8
<b>66781</b>	5/8"	4-1/4"	28,400 lb	66305	1045	EN-8
<b>66782</b>	5/8"	6-1/4"	28,400 lb	66305	1045	EN-8
<b>66783</b>	3/4"	4-1/4"	40,000 lb	66302	1045	EN-8
<b>66784</b>	3/4"	6-1/4"	40,000 lb	66302	1045	EN-8
<b>66785</b>	7/8"	6-1/4"	58,364 lb	66302	1045	EN-8
<b>102180</b>	1"	4-1/4"	40,000 lb	66304	1045	EN-8
<b>66786</b>	1"	6-1/4"	81,170 lb	66304	1045	EN-8
<b>66787</b>	1-1/8"	6-1/4"	88,930 lb	66304	1045	EN-8
<b>66788</b>	1-1/4"	6-1/4"	124,198 lb	66304	1045	EN-8
<b>102184</b>	3/8"	3-1/2"	--	66303	1045	EN-8
<b>102185</b>	1/2"	3-1/2"	20,100 lb	66303	1045	EN-8

Sizes are approximate. Specifications subject to change without notice.



## Hitch Pins - E-Grip

One piece solid hot forged heat treated alloy steel pin and handle. Wider ergonomic handle. Clip pin is included. Bright orange powder coat finish. Rockwell Hardness 36-42 (HRC)

PART#	PIN DIAMETER (A)	USABLE LENGTH (B)	MIN. BREAK LOAD	HAIR PIN CLIP #	STEEL TYPE (SAE)	STEEL GRADE
 <b>66872</b>	1/2"	3-1/2"	17,636	66303	1045	EN-8
 <b>66873</b>	5/8"	3-3/4"	32,470	66305	1045	EN-8
 <b>66874</b>	3/4"	4"	45,500	66302	1045	EN-8
 <b>66875</b>	5/8"	6"	31,331	66305	1045	EN-8
 <b>66876</b>	3/4"	6-1/4"	29,775	66302	1045	EN-8
 <b>66877</b>	7/8"	6-1/2"	58,682	66304	1045	EN-8
 <b>66878</b>	1"	6-3/4"	68,121	66304	1045	EN-8



## High Strength Hitch Pins - Grade 5

S.A.E. 1040 HiTensile steel. Heat Treated to Grade 5 specification. Rockwell Hardness 25-34 (HRC). Black powder-coated enamel pin. Red vinyl dipped handle. Supplied with hair pin clip.

PART#	PIN DIAMETER (A)	USABLE LENGTH (B)	STEEL TYPE (S.A.E.)	STEEL GRADE	MIN. BREAK LOAD	HAIR PIN CLIP #
 <b>66251</b>	1/2"	3-5/8"	1040	MS	30,093 lb	66303
 <b>66252</b>	5/8"	4"	1040	EN-8	38,779 lb	66305
 <b>66253</b>	3/4"	4-1/2"	1040	EN-8	38,064 lb	66302
 <b>66254</b>	7/8"	4-1/4"	1040	EN-8	47,021 lb	66304
 <b>66255</b>	1"	4-3/4"	1040	EN-8	63,814 lb	66304
 <b>66256</b>	5/8"	5-3/4"	1040	EN-8	38,779 lb	66305
 <b>66257</b>	3/4"	6-1/2"	1040	EN-8	38,064 lb	66302
 <b>66258</b>	7/8"	6-1/2"	1040	EN-8	47,021 lb	66302
 <b>66259</b>	1"	7-1/2"	1040	EN-8	63,814 lb	66304
 <b>*66260</b>	1-1/8"	8-1/2"	1040	EN-8	69,412 lb	66304
 <b>*66261</b>	1-1/4"	8-1/2"	1040	EN-8	75,010 lb	66304
 <b>*66263</b>	1-1/2"	8-1/2"	1040	EN-8	78,368 lb	66304
 <b>66886</b>	1"	12"	1040	EN-8	64,934 lb	66304
 <b>*66887</b>	1-1/8"	12"	1040	EN-8	73,890 lb	66304
 <b>*66888</b>	1-1/4"	12"	1040	EN-8	76,129 lb	66304
 <b>*66889</b>	1-1/2"	13"	1040	EN-8	80,607 lb	66304
 <b>102233</b>	1-3/4"	8-1/2"	1040	EN-8	--	66304
 <b>102234</b>	2"	8-1/2"	1040	EN-8	--	66304
 <b>*66890</b>	1-3/4"	13"	1040	EN-8	85,086 lb	66455 (Linch pin)



\*Rockwell Hardness 19-25 (HRC)

Sizes are approximate. Specifications subject to change without notice.

Legend:  12x24  24x24  Plan-0-Gram  Rack/End Cap  Other

**DYNALINE**



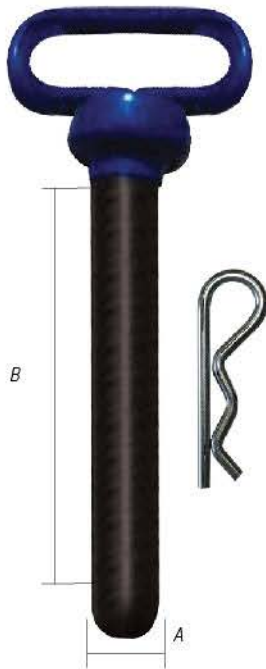

### High Strength Hitch Pins - Grade 8

Grade 8 forged blue head hitch pins. SAE 4140H Chromium and molybdenum alloy steel and heat treated to Grade 8 specification. Rockwell Hardness 32-38 (HRC) superior black powder coated finish on pin. Blue vinyl coating on head and handle. Hair pin clip is included.

PART#	PIN DIAMETER (A)	USABLE LENGTH (B)	STEEL TYPE (S.A.E.)	STEEL GRADE	MIN. BREAK LOAD	HAIR PIN CLIP #
<input type="checkbox"/> 66860	1/2"	3-5/8"	4140H Alloy	EN-8	36,945 lb	66303
<input type="checkbox"/> 66861	5/8"	4"	4140H Alloy	EN-8	38,064 lb	66305
<input type="checkbox"/> 66862	5/8"	6"	4140H Alloy	EN-8	39,184 lb	66305
<input type="checkbox"/> 66863	3/4"	4"	4140H Alloy	EN-8	45,901 lb	66302
<input type="checkbox"/> 66864	3/4"	6-1/2"	4140H Alloy	EN-8	47,021 lb	66302
<input type="checkbox"/> 66865	7/8"	4-1/4"	4140H Alloy	EN-8	52,619 lb	66304
<input type="checkbox"/> 66866	7/8"	6-1/2"	4140H Alloy	EN-8	51,499 lb	66304
<input type="checkbox"/> 66867	1"	4-3/4"	4140H Alloy	EN-8	61,575 lb	66304
<input type="checkbox"/> 66868	1"	7"	4140H Alloy	EN-8	62,695 lb	66304
<input type="checkbox"/> 66869	1-1/8"	7"	4140H Alloy	EN-8	72,770 lb	66304
<input type="checkbox"/> 66870	1-1/4"	7"	4140H Alloy	EN-8	76,129 lb	66304
<input type="checkbox"/> 66871	1-1/2"	8-1/2"	4140H Alloy	EN-8	80,607 lb	66304

Farm Hardware

### Forged Steel Hitch Pins

Hot forged, heat treated Grade 8, SAE-1541H alloy steel. Rockwell hardness 26-34 (HRC) Solid handle. Bright orange powder coat finish. Supplied with clip.



PART#	PIN DIAMETER (A)	USABLE LENGTH (B)	STEEL TYPE (S.A.E.)	MIN. BREAK LOAD	COMPATIBLE HAIR PIN CLIP #
<input type="checkbox"/> 66882	1-1/8"	7"	1541H Alloy	73,890 lb	66304
<input type="checkbox"/> 66883	1-1/4"	7"	1541H Alloy	77,249 lb	66304
66884	1-3/8"	7"	1541H Alloy	82,846 lb	66455 (Linch pin)
66885	1-1/2"	8"	1541H Alloy	80,607 lb	66455 (Linch pin)

### Locking Hitch Pins

Grade 5 performance hitch pins with quick release handle for easy removal.



PART#	PIN DIAMETER	USABLE LENGTH	WEIGHT (LBS.)
102248	5/8"	4-1/2"	2.0
102249	3/4"	4-1/2"	2.3
102250	3/4"	6"	2.6
102251	7/8"	4-1/2"	2.6
102252	7/8"	6"	2.9
102253	1"	6"	3.3
102254	1-1/8"	7"	4.1
102255	1-1/4"	7"	4.6
102256	1-1/2"	8"	5.7

Sizes are approximate. Specifications subject to change without notice.

**Lynch Pins**

Forged C-1010 steel pin. Yellow zinc dichromate plated finish. Available in two package types: Bag and Dynapak (quantities in each are seen below).

	PART#	DESCRIPTION	PACKAGE QUANTITY	PART #	PACKAGE QUANTITY	PIN DIAMETER (A)	USABLE LENGTH (B)	RING DIAMETER (C)	CHAIN LENGTH
	<b>66450</b>	Lynch Pin, standard	10	<b>96450</b>	4	3/16"	1-1/8"	1-1/4"	--
	<b>102343</b>	Lynch Pin, with chain & cotter pin	1	--	--	3/16"	1"	1-1/4"	12"
	<b>66451</b>	Lynch Pin, standard	10	<b>96451</b>	4	1/4"	1-1/2"	1-11/16"	--
	<b>102347</b>	Lynch Pin, short shank	1	--	--	7/16"	1-1/4"	1-7/16"	--
	<b>102348</b>	Lynch Pin, heavy duty, black fits Category 1, 2, & 3 pins*	1	--	--	7/16"	1-1/2"	1-9/16"	--
	<b>102349</b>	Lynch Pin, with chain & cotter pin, black*	1	--	--	7/16"	1-1/2"	1-11/16"	9-3/8"
	<b>66452</b>	Lynch Pin, standard	10	<b>96452</b>	4	5/16"	1-7/16"	1-5/8"	--
	<b>66453</b>	Lynch Pin, standard	10	<b>96453</b>	4	3/8"	1-1/2"	1-3/4"	--
	<b>66454</b>	Lynch Pin, standard	10	<b>96454</b>	4	7/16"	1-7/16"	1-5/8"	--
	<b>102345</b>	Lynch Pin, with chain & cotter pin	1	--	--	7/16"	1-1/4"	1-11/16"	12-5/16"
	<b>66455</b>	Lynch Pin, standard	10	<b>96455</b>	4	7/16"	1-7/8"	2-1/8"	--
	<b>102353</b>	Lynch Pin, long shank	1	--	--	7/16"	1-1/4"	1-9/16"	--
	<b>102354</b>	Lynch Pin, with 12" chain and hook, fits Category 1, & 2 pins	1	--	--	5/16"	1-3/8"	1-5/8"	--
	<b>102355</b>	Lynch Pin, with 12" chain and hook, fits Category 1, & 2 pins	1	--	--	1/4"	1-1/2"	1-9/16"	--

4 Piece Dynapak

102343  
102345  
102349 (black)102354  
102355**Spring Lock Pins**

Spring steel wire holds pin in place, grooved pin secures wire, clear zinc finish, carbon steel pin. C-1144 stress-proof steel. (Sold Individually)

	PART#	PIN DIAMETER (A)	USABLE LENGTH (B)
	<b>66244</b>	1/2"	4-1/4"
	<b>102241</b>	1/2"	3-1/2"
	<b>102242</b>	1/4"	1-3/4"
	<b>102243</b>	1/4"	2-1/8"
	<b>102244</b>	5/16"	2-1/4"
	<b>102245</b>	5/16"	2-1/2"
	<b>102246</b>	3/8"	1-1/2"
	<b>102247</b>	3/8"	2-3/8"
	<b>66245</b>	5/8"	4-1/4"
	<b>66246</b>	3/4"	4-1/4"
	<b>66247</b>	3/4"	6-1/4"
	<b>66248</b>	7/8"	6-1/4"
	<b>66249</b>	1"	6-1/4"

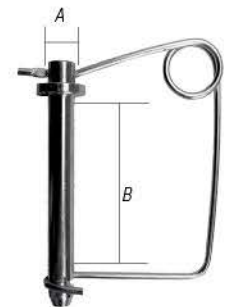

Sizes are approximate. Specifications subject to change without notice.

Legend:  12x24  24x24  Plan-O-Gram  Rack/End Cap  Other



Dynapak



### Round Quick Pins

C-10105 Grade 5 steel. Clear zinc plated finish. Available in two package types: Bag and Dynapak (quantities in each are seen below)

BAG PACK		DYNAPAK		PIN DIAMETER (A)	USABLE LENGTH (B)	C	D	
PART#	PACKAGE QUANTITY	PART #	PACKAGE QUANTITY					
	<b>66460</b>	5	<b>96460</b>	2	1/4"	1-3/8"	1-5/8"	1-5/8"
	<b>102473</b>	1	--	--	1/4"	2-1/2"	1-1/2"	2-3/4"
	<b>66461</b>	5	<b>96461</b>	2	1/4"	1-3/4"	1-5/8"	2"
	<b>102470</b>	1	--	--	5/16"	2-1/4"	1-1/2"	2-11/16"
	<b>102471</b>	1	--	--	3/8"	2-1/4"	1-7/16"	2-11/16"
	<b>66463</b>	5	<b>96463</b>	2	5/16"	1-3/8"	1-5/8"	1-5/8"
	<b>66464</b>	5	<b>96464</b>	2	5/16"	1-3/4"	1-5/8"	2"
	<b>102478</b>	1	--	--	5/16"	2-1/2"	1-5/8"	2-7/8"
	<b>66466</b>	5	<b>96466</b>	2	3/8"	1-3/8"	1-5/8"	1-5/8"
	<b>102483</b>	1	--	--	3/8"	1-3/4"	1-1/2"	2-3/16"
	<b>102484</b>	1	--	--	3/8"	2-1/2"	1-1/2"	3"
	<b>66469</b>	1	<b>96469</b>	1	5/8"	3-1/8"	1-1/2"	3-1/2"

### Square Quick Pins

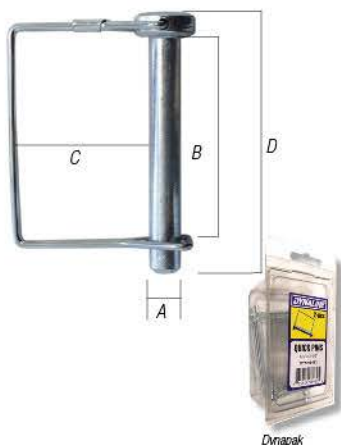

BAG PACK		DYNAPAK		PIN DIAMETER (A)	USABLE LENGTH (B)	C	D	
PART#	PACKAGE QUANTITY	DYNAPAK	PACKAGE QUANTITY					
	<b>102474</b>	1	--	--	1/4"	2-1/4"	1-7/16"	2-15/16"
	<b>66462</b>	5	<b>96462</b>	2	1/4"	2-1/2"	1-5/8"	2-3/4"
	<b>102469</b>	1	--	--	5/16"	2-1/4"	1-1/2"	2-15/16"
	<b>66465</b>	5	<b>96465</b>	2	5/16"	2-1/2"	1-5/8"	2-3/4"
	<b>102480</b>	1	--	--	5/16"	3-1/2"	1-7/8"	4-3/16"
	<b>66467</b>	5	<b>96467</b>	2	3/8"	2-1/4"	1-5/8"	2-1/2"
	<b>66468</b>	5	<b>96468</b>	2	3/8"	2-1/2"	1-5/8"	2-3/4"
	<b>102487</b>	1	--	--	3/8"	3"	1-9/16"	3-3/4"
	<b>102488</b>	1	--	--	3/8"	3-7/16"	2-1/16"	4-1/4"

### Round Tab Type Quick Pins

Easier to use than standard wire lock pins. C-1010 steel. Clear zinc plated finish.

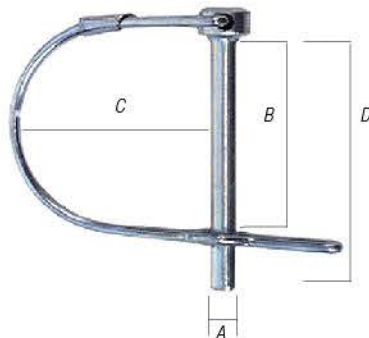

PART#	PACKAGE QUANTITY	PIN DIAMETER (A)	USABLE LENGTH (B)	C	D	
	<b>66531</b>	5	1/4"	1-5/8"	1-5/8"	2-1/8"
	<b>66532</b>	5	1/4"	2"	1-5/8"	2-3/16"
	<b>66533</b>	5	1/4"	2-3/4"	1-5/8"	3-1/8"
	<b>66534</b>	5	5/16"	1-5/8"	1-5/8"	2-1/8"
	<b>66535</b>	5	5/16"	2"	1-5/8"	2-3/16"
	<b>66536</b>	5	5/16"	2-3/4"	1-5/8"	3-1/8"
	<b>66537</b>	5	3/8"	1-5/8"	1-5/8"	2-1/2"
	<b>66538</b>	5	3/8"	2-1/2"	1-5/8"	2-11/16"
	<b>66539</b>	5	3/8"	2-3/4"	1-5/8"	3-1/8"

Sizes are approximate. Specifications subject to change without notice.



**Reference Chart Available**  
 See end of catalogue

### Hair Pin Clips - Internal

Oil tempered MB spring wire. Clear zinc plated finish. Available in two package types: Bag and Dynapak (quantities in each are seen below)

	BAG PACK		DYNAPAK								
	PART#	PACKAGE QUANTITY	PART #	PACKAGE QUANTITY	IND.#	WIRE DIAMETER	DRILL HOLE SIZE	MIN. SHAFT DIAMETER	MAX. SHAFT DIAMETER	OVERALL LENGTH	INSIDE EYE DIAMETER
<input type="checkbox"/>	66300	25	96300	10	22	1/16"	5/64"	1/4"	1/2"	1-3/8"	1/4"
<input type="checkbox"/>	66301	25	96301	10	3	3/32"	7/64"	1/4"	1/2"	1-11/16"	7/16"
<input type="checkbox"/>	66302	25	96302	4	6	3/16"	7/32"	5/8"	1"	3-1/4"	7/8"
<input type="checkbox"/>	66303	25	96303	10	7	3/32"	7/64"	3/8"	5/8"	2-5/16"	5/8"
<input type="checkbox"/>	66304	25	96304	5	8	3/16"	7/32"	7/8"	1-1/4"	3-3/4"	7/8"
<input type="checkbox"/>	66305	25	96305	5	9	5/32"	11/64"	3/4"	1-1/8"	3-5/16"	3/4"
<input type="checkbox"/>	66306	25	96306	5	11	1/8"	9/64"	7/16"	3/4"	2-5/8"	9/16"
<input type="checkbox"/>	66307	25	96307	10	16	1/8"	9/64"	1/2"	3/4"	2"	1/2"
<input type="checkbox"/>	66308	10	96308	3	19	1/4"	17/64"	3/4"	1"	4-1/4"	3/4"
<input type="checkbox"/>	102312	1	--	--	--	5/16"	21/64"	1"	1-7/16"	5-15/16"	1-3/8"
<input type="checkbox"/>	66309	25	--	--	1	5/32"	11/64"	1/2"x5/8"	5/8"x1"	3"	1/2"
<input type="checkbox"/>	66310*	25	--	--	2	1/8"	9/64"	3/4"	1-1/8"	3-1/4"	1"
<input type="checkbox"/>	66313	25	--	--	4	11/64"	3/16"	1/2"x3/4"	5/8"x1"	3"	5/8"
<input type="checkbox"/>	66317	25	--	--	17	3/32"	7/64"	3/8"	1/2"	1-9/16"	5/16"
<input type="checkbox"/>	66318	25	--	--	18	1/16"	5/64"	3/8"	1/2"	1-9/16"	5/16"
<input type="checkbox"/>	66320	10	--	--	20	5/16"	21/64"	7/8"	1"	4"	7/8"
<input type="checkbox"/>	66325	25	--	--	25	5/64"	3/32"	5/16"	3/8"	1-3/32"	9/64"
<input type="checkbox"/>	66326	25	--	--	10	5/32"	11/64"	5/8"	1"	2-15/16"	3/4"
<input type="checkbox"/>	66328	25	--	--	14	3/32"	7/64"	1/2"	3/4"	2-1/2"	5/8"

\*66310 - Rounded head, see image below.

### Twist Clip Pins

Easily attaches and holds more securely than the commonly used "R" clip pin.

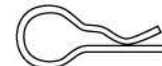

PART#	PACKAGE QUANTITY	WIRE DIAMETER	OVERALL LENGTH	FITS PIN DIAMETER	WEIGHT (LBS.)
102303	10	1/8"	2-1/2"	1/2" to 7/8"	0.02
102304	10	5/32"	3-1/32"	5/8" to 1"	0.04
102305	10	3/16"	4-3/32"	3/4" to 1-1/4"	0.06

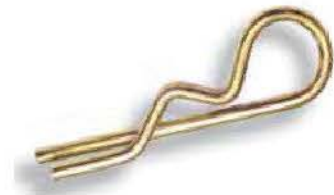

### Hair Pin Clips - External

Oil tempered MB spring wire. Clear zinc plated finish. Available in two package types: Bag and Dynapak (quantities in each are seen below)

	BAG PACK		DYNAPAK					
	PART#	PACKAGE QUANTITY	DYNAPAK	PACKAGE QUANTITY	IND.#	WIRE DIAMETER	OVERALL LENGTH	INSIDE EYE DIAMETER
<input type="checkbox"/>	66311	25	96311	5	7XX	7/64"	2-1/16"	7/16"
<input type="checkbox"/>	66312	25	96312	4	10X	11/64"	2-5/8"	3/4"



Farm Hardware

Sizes are approximate. Specifications subject to change without notice.



### Bronze Bushings

S.A.E. 841 Bronze material. Oil impregnated.

PART#	THICKNESS	INNER DIAMETER	OUTER DIAMETER	LENGTH	PART#	THICKNESS	INNER DIAMETER	OUTER DIAMETER	LENGTH
55300	1/32"	1/4"	5/16"	3/4"	55326	1/16"	7/8"	1"	1-1/4"
55301	1/16"	1/4"	3/8"	1"	55327	1/8"	7/8"	1-1/8"	1-1/4"
55302	3/32"	1/4"	7/16"	1"	55328	3/16"	7/8"	1-1/4"	1-1/4"
55303	1/8"	1/4"	1/2"	1"	55329	5/32"	15/16"	1-1/4"	1-1/4"
55304	1/32"	5/16"	3/8"	1"	55330	1/8"	1"	1-1/4"	1-1/2"
55305	1/16"	5/16"	7/16"	1"	55331	3/16"	1"	1-3/8"	1-1/2"
55306	1/16"	3/8"	1/2"	1"	55332	1/4"	1"	1-1/2"	1-1/2"
55307	1/8"	3/8"	5/8"	1"	55333	1/8"	1-1/16"	1-5/16"	1-1/2"
55308	3/16"	3/8"	3/4"	1"	55334	1/16"	1-1/8"	1-1/4"	1-1/2"
55309	1/16"	7/16"	9/16"	1"	55335	1/8"	1-1/8"	1-3/8"	1-1/2"
55310	3/32"	7/16"	5/8"	1"	55336	3/16"	1-1/8"	1-1/2"	1-1/2"
55311	1/16"	1/2"	5/8"	1"	55337	1/8"	1-3/16"	1-7/16"	1-1/2"
55312	3/32"	1/2"	11/16"	1"	55338	5/32"	1-3/16"	1-1/2"	1-1/2"
55313	1/8"	1/2"	3/4"	1"	55339	1/8"	1-1/4"	1-1/2"	1-1/2"
55314	5/32"	1/2"	13/16"	1"	55340	3/16"	1-1/4"	1-5/8"	1-1/2"
55315	3/16"	1/2"	7/8"	1"	55341	1/8"	1-3/8"	1-5/8"	1-1/2"
55316	3/32"	9/16"	3/4"	1"	55342	3/16"	1-3/8"	1-3/4"	1-1/2"
55317	1/8"	9/16"	13/16"	1"	55343	5/32"	1-7/16"	1-3/4"	1-1/2"
55318	1/16"	5/8"	3/4"	1-1/4"	55344	1/8"	1-1/2"	1-3/4"	1-1/2"
55319	3/32"	5/8"	13/16"	1-1/4"	55345	3/16"	1-1/2"	1-7/8"	1-1/2"
55320	1/8"	5/8"	7/8"	1-1/4"	55346	3/16"	1-5/8"	2"	1-1/2"
55321	3/16"	5/8"	1"	1-1/4"	55347	1/8"	1-3/4"	2"	1-1/2"
55322	1/16"	3/4"	7/8"	1-1/4"	55348	3/16"	1-3/4"	2-1/8"	1-1/2"
55323	3/32"	3/4"	15/16"	1-1/4"	55349	1/8"	2"	2-1/4"	1-1/2"
55324	1/8"	3/4"	1"	1-1/4"	55350	3/16"	2"	2-3/8"	1-1/2"
55325	3/32"	13/16"	1"	1-1/4"					



### Bronze Bushings

Bronze sleeve bushings or bronze bearings are hard and strong, as opposed to brass bushings, which are softer and more easily deform. Thus, bronze bushings have longer lifespans than brass bushing sleeves. They resist shock and impact, wear and corrosion.

They require an external lubricant, for example grease or oil, at installation and during operation to reduce friction and wear.

Sizes are approximate. Specifications subject to change without notice.



### Lift Arm Bushings

Carbon steel. Yellow zinc dichromate plated finish.

PART#	REFERENCE#	CATEGORY	INSIDE DIAMETER	OUTSIDE DIAMETER	OVERALL LENGTH
102066	--	0-1	5/8"	7/8"	1-3/8"
□ 66608	0351	1 to 2	7/8"	1-1/8"	1-3/4"
102068	--	1-2	7/8"	1-1/8"	1-3/8"
□ 66610	3009	2 to 3	1-1/8"	1-7/16"	1-3/4"
102070	--	2-3	1-1/8"	1-7/16"	3-1/4"
□ 66612	3010	2 to 3	1-1/8"	1-7/16"	2-1/2"
102072	--	2-3	1-1/8"	1-7/16"	2-3/4"
102073	--	1	7/8"	1-1/8"	4"
102075	--	2	1-1/8"	1-7/16"	4"



### Top Link Bushings

Carbon steel. Yellow zinc dichromate plated finish.  
 Used in the pin hole of a top link to allow a smaller category pin to fit.

PART#	REFERENCE#	CATEGORY	INSIDE DIAMETER	OUTSIDE DIAMETER	OVERALL LENGTH
□ 66602	0353	1 to 2	3/4"	1"	2"
□ 66604	3008	2 to 3	1"	1-1/4"	2"
102062	--	0-1	5/8"	3/4"	1-5/8"
102063	--	1-2	3/4"	1"	1-5/8"
102064	--	1-2	3/4"	1"	1-5/16"
102065	--	2-3	1"	1-1/4"	1-5/8"



### Drawbars

One piece 3-point hitch cross drawbars to fit Category 0 through Category 3 tractors.

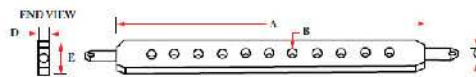

PART#	CAT.	NUMBER OF HOLES	A LIFT ARM SPACING	B HOLE DIAMETER	C PIN DIAMETER	D THICKNESS	E WIDTH
102077	0	7	20"	5/8"	5/8"	3/4"	2"
102078	0/1	7	20"	3/4"	7/8"	1"	2-1/2"
102079	1	11	26"	3/4"	7/8"	1"	2-1/2"
102082	2	13	32"	3/4"	1-1/8"	1-1/4"	3



Farm Hardware

Sizes are approximate. Specifications subject to change without notice.





### Top Links

Carbon steel, forged & welded. With grease fitting, nut welded. Yellow zinc dichromate plated finish. UNC Coarse Thread.

PART#	REFERENCE#	CATEGORY	HOLE DIAMETER	THREAD DIAMETER	ADJUSTMENT (OUTSIDE TO OUTSIDE)
102000	--	0	5/8"	3/4" NC	13" - 18"
66619	480	0	5/8"	3/4"	11" - 16"
102004	--	1	3/4"	1-1/8" NC	25" - 35"
102006	--	1	3/4"	1-1/8" NC	16" - 23"
66620	331	1	3/4"	1-1/8"	21" - 31"
66621	338	1 & 2	3/4" & 1"	1-1/8" & 1-1/4"	21" - 32"
66622	337	2	1"	1-1/8"	25" - 36"
102011	--	2	1"	1-1/4" NC	20" - 30"
102015	--	3	1-1/4"	1-3/8" NC	26" - 35"
66624	336	2	1"	1-1/8"	21" - 32"

### Top Link Repair Ends

Carbon steel, forged & welded. Yellow zinc dichromate plated finish. UNC Coarse Thread.



PART#	REFERENCE#	CATEGORY	HOLE DIAMETER	THREAD DIAMETER	THREAD LENGTH
102016	--	0	5/8"	3/4" NC (RH)	3-1/2"
102017	--	0	5/8"	3/4" NC (LH)	3-1/2"
66625	342	1	3/4"	1-1/8" LH	6"
66626	343	1	3/4"	1-1/8" RH	6"
102020	--	2	1"	1-1/4" NC (LH)	5-1/2"
102021	--	2	1"	1-1/4" NC (RH)	5-1/2"
66627	346	2	1"	1-1/8" LH	6-1/2"
66628	347	2	1"	1-1/8" RH	6-1/2"
102024	--	3	1-1/4"	1-3/8" NC (LH)	7-1/4"
102025	--	3	1-1/4"	1-3/8" NC (RH)	7-1/4"

Sizes are approximate. Specifications subject to change without notice.



## Ratchet Jack

Heavy duty. Replace hydraulic cylinders or old screw jacks in those applications where infrequent adjustment is needed. Clip pins and handle included.

PART#	A	B	C	THREAD DIAMETER	LENGTH CLOSED	LENGTH EXTENDED
66642	1-1/2"	1"	2-3/4"	1-1/4"	20"	28"



## Stabilizer Pins

Stabilizer stub pins for Ford, Ferguson, and other stabilizer kits. Yellow zinc dichromate plated.

PART#	PIN DIAMETER	USABLE LENGTH	OVERALL LENGTH	THREAD DIAMETER	WASHER & NUT
102095	7/8"	1/2"	3-1/4"	7/8" NF	Yes
102096	7/8"	3/8"	2-5/8"	5/8" NF	Yes
102097	7/8"	3/8"	2-5/8"	5/8" NF	No
102098	7/8"	1-1/4"	3-1/8"	5/8" NF	Yes
102099	7/8"	1-1/4"	3-1/8"	5/8" NF	No
102100	7/8"	1/2"	2-5/8"	5/8" NF	Yes
102101	7/8"	1/2"	2-5/8"	5/8" NF	No
102102	7/8"	11/16"	3-1/8"	3/4" NF	Yes



## Top Link Pins

Carbon steel, forged & welded. Yellow zinc dichromate plated finish. UNC Coarse Thread.

PART#	REFERENCE#	CATEGORY	PIN DIAMETER	USABLE LENGTH	OVERALL LENGTH
□ 66560	73	1	3/4"	2-3/4"	4-1/2"
□ 66561	74	1	3/4"	3-7/8"	5-1/2"
□ 66562	76	2	1"	3-9/16"	5-1/4"
□ 66563	7715	1	3/4"	4-3/4"	6-3/8"
□ 102152	--	2	1"	4-3/8"	6"
□ 66565	3011	2	1"	4-5/16"	6"
□ 102154	--	2	1"	5-3/8"	7-1/16"
□ 66566	7711	3	1/4"	4-5/8"	6-1/2"
□ 66567	7706	0	5/8"	3"	4-7/16"



Farm Hardware





Farm Hardware



## Lift Arm Pins

Carbon steel. Yellow zinc dichromate plated finish. UNF Thread (Unified National Fine)

	PART#	REFERENCE#	CATEGORY	PIN DIAMETER	THREAD DIAMETER	USABLE LENGTH	OVERALL LENGTH
□	66580	200	1	7/8"	7/8" NF	1-3/4"	5-1/2"
□	66581	3000	1	7/8"	7/8" NF	Adjustable	6-1/4"
□	66582	3004	1	7/8"	7/8" NF	2-1/4"	6-1/2"
□	66583	3001	1 to 2	1-1/8"	7/8" NF	Adjustable	5-3/16"
	66584	7243	2 to 3	1-7/16"	1-1/8" NF	1-7/8"	5-3/4"
NEW	102134	--	3	1-7/16"	1-3/8" NF	2"	5-7/8"
□	66585	202	1 to 2	1-1/8"	7/8" NF	1-3/4"	5-1/4"
	66586	7249	1 to 2	7/8-11/8"	1" NF	2-1/6"	8"
□	66587	3022	2 to 1	7/8"	1-1/8" NF	1-3/4"	5-3/4"
NEW	102132	--	2 - 3	1-7/16"	1-1/8" NF	Adjustable	6-1/2"
□	66588	3006	2	1-1/8"	1-1/8" NF	1-3/4"	6-1/8"
	66589	3002	2	1-1/8"	1-1/8" NF	Adjustable	6-1/8"
□	66590	211	1	7/8"	7/8" NF	Adjustable	5-5/16"
	66591	7220	0	5/8"	5/8" NF	Adjustable	3-7/8"
NEW	102116	--	0	5/8"	5/8" NF	1-7/16"	3-7/8"
NEW	102117	--	0 - 1	7/8"	5/8" NF	Adjustable	4-1/2"
NEW	102118	--	1 - 0	5/8"	7/8" NF	2"	5"
NEW	102124	--	1	7/8"	5/8" NF	1-3/4"	4-1/2"
	66592	7246	1 to 2	1-1/8"	7/8" NF	2-1/4"	6-5/16"



102141,102144



102145,102146

## Clevis Type Draw Pins

Stabilizer stub pins for Ford, Ferguson, and other stabilizer kits. Yellow zinc dichromate plated.

	PART#	CAT.	TYPE	PIN DIAMETER	USABLE LENGTH	OVERALL LENGTH
	102141	3	Head	1-7/16"	4-11/16"	6"
NEW	102144	2	Head	1-1/8"	5"	6"
NEW	102145	1 & 2	Head	7/8"	3-1/4" & 4-1/2"	9-1/4"
NEW	102146	1	Head	7/8"	4"	5-1/4"

Sizes are approximate. Specifications subject to change without notice.



### Plastic Document Holders

Molded from high density polypropylene, weather and impact resistant. Protects documents from damage. Mounts onto machines for easy access. O-Ring sealed. Screw top lid.



PART#	DESCRIPTION
17710	Plastic Holder 2-1/4" diameter x 12-1/2" long
17720	Plastic Holder 2" diameter x 12-1/2" long
17730	Plastic Holder 3-1/4" diameter x 14" long
17731	Tether for plastic holder 17720 and 17730

### Aluminum Document Holder

Made from corrosion resistant aluminum. Protects documents from the elements.

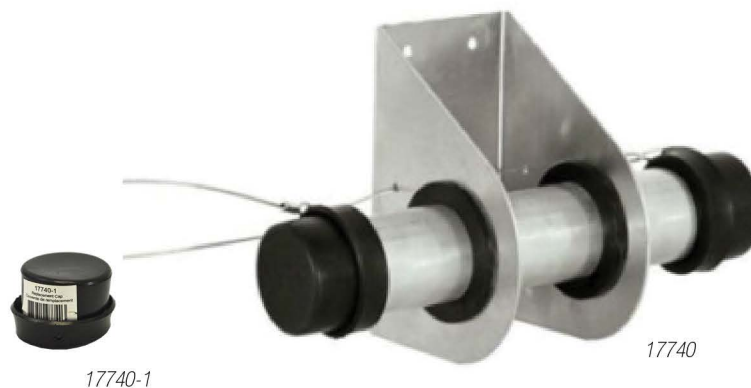

PART#	DESCRIPTION
17740	1.5" inside diameter x 9" long
17740-1	Rubber cap replacement for 17740

Sizes are approximate. Specifications subject to change without notice.

